

DETAILS

Product Number	F13401_ANGELINA-M
Family	ANGELINA
Type	Reflector
Color	metal
Diameter	82 mm
Height	31 mm
Style	round
Optic Material	PC
Holder Material	
Fastening	
Status	production ready
ROHS Compliant	Yes
Date Updated	31/01/2017



OPTICAL PROPERTIES

LED	Viewing Angle	Light Beam	Efficiency	cd/lm	Connector
BXRA ES Rectangle	30 deg	Medium	93 %	1.570	IDEAL: 50-2100BL + 50-2100AN
V22 Gen6	43 deg	Medium	91 %	1.100	IDEAL: 50-2204-CT + 50-2100AN
V13 Gen7	34 deg	Medium	92 %	1.400	TE: 2213254-2 + OPTIC CLIP Z50 TYPE1 2213194-1
V22 Gen7	sim: 34	Medium	sim: 94 %	sim: 1.659	IDEAL: 50-2204-CT + 50-2100AN
V13 Gen7	sim: 28	Medium	sim: 93 %	sim: 2.050	IDEAL: 50-2103CT + 50-2100AN
CLL03x/CLU03x	30 deg	Medium	92 %	1.550	IDEAL: 50-2103CT + 50-2100AN
CLL03x/CLU03x	35 deg	Medium	94 %	1.400	TE: 2213254-2 + OPTIC CLIP Z50 TYPE1 2213194-1
CLU720/721	26 deg	Medium	93 %	1.600	IDEAL: 50-2103CT + 50-2100AN
CLU720/721	31 deg	Medium	94 %	1.400	TE: 2213254-2 + OPTIC CLIP Z50 TYPE1 2213194-1
CLL04x/CLU04x	43 deg	Medium	91 %	1.100	IDEAL: 50-2204-CT + 50-2100AN
CLU730/731	31 deg	Medium	91 %	1.400	IDEAL: 50-2204-CT + 50-2100AN
CXA/B 25xx	34 deg	Medium	93 %	1.370	IDEAL: 50-2102CR + 50-2100AN
CXA/B 30xx	40 deg	Medium	93 %	1.180	IDEAL: 50-2234C + 50-2100AN
CXA/B 1816 & CXA/B 1820 & CXA 1850	26 deg	Medium	93 %	1.700	IDEAL: 50-2101CR + 50-2100AN
CXA/B 3590	54 deg	Medium	92 %	0.910	IDEAL: 50-2303CR + 50-2300AN
COB 10W/13W/17W/24W	28 deg	Medium	92 %	1.640	IDEAL: 50-2100LG + 50-2100AN
LUXEON K16	32 deg	Medium	94 %	1.500	TE: 2213134-2 + OPTIC CLIP Z50 TYPE1 2213194-1
LUXEON K12	29 deg	Medium	94 %	1.600	TE: 2213134-2 + OPTIC CLIP Z50 TYPE1 2213194-1
LUXEON CoB 1204/1205	30 deg	Medium	94 %	1.800	TE: 2213130-2 + OPTIC CLIP Z50 TYPE1 2213194-1
LUXEON CoB 1208	32 deg	Medium	93 %	1.600	TE: 2213130-2 + OPTIC CLIP Z50 TYPE1 2213194-1
LUXEON CoB 1204/1205	28 deg	Medium	92 %	1.610	IDEAL: 50-2100SH + 50-2100AN
LUXEON CoB 1208	31 deg	Medium	93 %	1.500	IDEAL: 50-2100SH + 50-2100AN
LUXEON CoB 1211	39 deg	Medium	91 %	1.200	IDEAL: 50-2204-CT + 50-2100AN
CXM-14	34 deg	Medium	93 %	1.380	TE: 2213254-2 + OPTIC CLIP Z50 TYPE1 2213194-1
COB J-Type	31 deg	Medium	94 %	1.520	IDEAL: 50-2103NC + 50-2100AN

OPTICAL PROPERTIES

LED	Viewing Angle	Light Beam	Efficiency	cd/lm	Connector
COB L-Type (LES 11)	27 deg	Medium	91 %	1.640	IDEAL: 50-2100NC + 50-2100AN
COB L-Type (LES 11)	37 deg	Medium	94 %	1.270	Molex: 180580-0005
COB L-Type (LES 11)	31 deg	Medium	91 %	1.440	TE: 2213382-2 + OPTIC CLIP Z50 TYPE1 2213194-1
PrevaLED Core Z3 LES9	26 deg	Medium	93 %	1.730	TE: OPTIC CLIP Z50 TYPE1 2213194-1
PrevaLED Core Z3 LES23	43 deg	Medium	94 %	1.160	TE: OPTIC CLIP Z50 TYPE1 2213194-1
PrevaLED Core Z3 LES19	37 deg	Medium	93 %	1.300	TE: OPTIC CLIP Z50 TYPE1 2213194-1
Soleriq S13	34 deg	Medium	94 %	1.500	TE: 2213401-2 + OPTIC CLIP Z50 TYPE1 2213194-1
Soleriq S19	37 deg	Medium	93 %	1.310	TE: 2213407-2 + OPTIC CLIP Z50 TYPE1 2213194-1
PrevaLED Core AC (LEP-800)	28 deg	Medium	93 %	1.630	TE: OPTIC CLIP Z50 TYPE1 2213194-1
PrevaLED Core AC (LEP-2000)	36 deg	Medium	93 %	1.310	TE: OPTIC CLIP Z50 TYPE1 2213194-1
PrevaLED Core Z4 LES19	34 deg	Medium	93 %	1.400	TE: OPTIC CLIP Z50 TYPE1 2213194-1
Soleriq P13	33 deg	Medium	93 %	1.380	TE: 2213401-2 + OPTIC CLIP Z50 TYPE1 2213194-1
Soleriq S13 Gen2	30 deg	Medium	91 %	1.500	IDEAL: 50-2103CT + 50-2100AN
Soleriq S13 Gen2	34 deg	Medium	93 %	1.400	TE: 2213382-2 + OPTIC CLIP Z50 TYPE1 2213194-1
Fortimo SLM 2000 G3	35 deg	Medium	90 %	1.500	TE: OPTIC CLIP Z50 TYPE1 2213194-1
Fortimo SLM 4500 G3	39 deg	Medium	89 %	1.300	TE: OPTIC CLIP Z50 TYPE1 2213194-1
Fortimo SLM 3000 G3	35 deg	Medium	90 %	1.500	TE: OPTIC CLIP Z50 TYPE1 2213194-1
Fortimo LED SLM L9 G4 standard	27 deg	Medium	92 %	1.600	TE: OPTIC CLIP Z50 TYPE1 2213194-1
Fortimo LED SLM L13 G4 standard	31 deg	Medium	93 %	1.500	TE: OPTIC CLIP Z50 TYPE1 2213194-1
Fortimo LED SLM L15 G4 standard	34 deg	Medium	92 %	1.400	TE: OPTIC CLIP Z50 TYPE1 2213194-1
Fortimo LED SLM L19 G4 standard	39 deg	Medium	91 %	1.200	TE: OPTIC CLIP Z50 TYPE1 2213194-1
Fortimo SLM G5 LES 9 Standard	27 deg	Medium	92 %	1.600	TE: OPTIC CLIP Z50 TYPE1 2213194-1
Fortimo SLM G5 LES 9 Standard	27 deg	Medium	92 %	1.600	TE: OPTIC CLIP Z50 TYPE1 2213194-1
Fortimo SLM G5 LES 15 Standard	35 deg	Medium	90 %	1.300	TE: OPTIC CLIP Z50 TYPE1 2213194-1
Fortimo SLM G5 LES 19 Standard	40 deg	Medium	89 %	1.160	TE: OPTIC CLIP Z50 TYPE1 2213194-1
Fortimo SLM G5 LES 13 Standard	32 deg	Medium	91 %	1.450	TE: OPTIC CLIP Z50 TYPE1 2213194-1
Fortimo SLM 1211 L19 G6 Standard	39 deg	Medium	91 %	1.200	TE: OPTIC CLIP Z50 TYPE1 2213194-1
LC026B/LC040B	39 deg	Medium	93 %	1.200	TE: 2213258-2 + OPTIC CLIP Z50 TYPE1 2213194-1
LC040C	32 deg	Medium	91 %	1.400	TE: 2213382-2 + OPTIC CLIP Z50 TYPE1 2213194-1
Mega Zenigata (GW6DME)	32 deg	Medium	92 %	1.600	TE: 2213130-2 + OPTIC CLIP Z50 TYPE1 2213194-1
Mega Zenigata (GW6DME)	30 deg	Medium	93 %	1.530	IDEAL: 50-2100SH + 50-2100AN
STARK SLE G2 LES19	33 deg	Medium	92 %	1.500	TE: OPTIC CLIP Z50 TYPE1 2213194-1
STARK SLE G2 LES23	38 deg	Medium	90 %	1.300	TE: OPTIC CLIP Z50 TYPE1 2213194-1
STARK SLE G2 LES26	41 deg	Medium	89 %	1.200	TE: OPTIC CLIP Z50 TYPE1 2213194-1
STARK SLE G3 LES19	38 deg	Medium	92 %	1.200	TE: OPTIC CLIP Z50 TYPE1 2213194-1
STARK SLE G3 LES23	43 deg	Medium	90 %	1.100	TE: OPTIC CLIP Z50 TYPE1 2213194-1
SLE G4 LES23 H	41 deg	Medium	93 %	1.200	TE: OPTIC CLIP Z50 TYPE1 2213194-1
SLE G4 LES19 H	35 deg	Medium	89 %	1.300	TE: OPTIC CLIP Z50 TYPE1 2213194-1
SLE G5 LES15	34 deg	Medium	93 %	1.400	TE: 2213254-2 + OPTIC CLIP Z50 TYPE1 2213194-1
SLE G5 LES19 H	36 deg	Medium	92 %	1.300	TE: OPTIC CLIP Z50 TYPE1 2213194-1
SLE G5 LES23 H	42 deg	Medium	92 %	1.140	TE: OPTIC CLIP Z50 TYPE1 2213194-1
WU-M-461	35 deg	Medium	93 %	1.350	TE: OPTIC CLIP Z50 TYPE1 2213194-1



PRODUCT DATASHEET
ANGELINA series
last update 31/1/2017

WU-M-462

42 deg

Medium

93 %

1.180

TE: OPTIC CLIP Z50 TYPE1 2213194-1



PRODUCT DATASHEET
ANGELINA series
last update 31/1/2017

WU-M-464

42 deg

Medium

93 %

1.170

TE: OPTIC CLIP Z50 TYPE1 2213194-1



PRODUCT DATASHEET
ANGELINA series
last update 31/1/2017

WU-M-484

36 deg

Medium

93 %

1.350

TE: OPTIC CLIP Z50 TYPE1 2213194-1



PRODUCT DATASHEET
ANGELINA series
last update 31/1/2017

WU-M-485

43 deg

Medium

93 %

1.150

TE: OPTIC CLIP Z50 TYPE1 2213194-1



PRODUCT DATASHEET
ANGELINA series
last update 31/1/2017

WU-M-486

42 deg

Medium

92 %

1.170

TE: OPTIC CLIP Z50 TYPE1 2213194-1

D

C

B

A

4

4

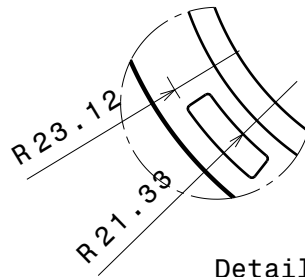
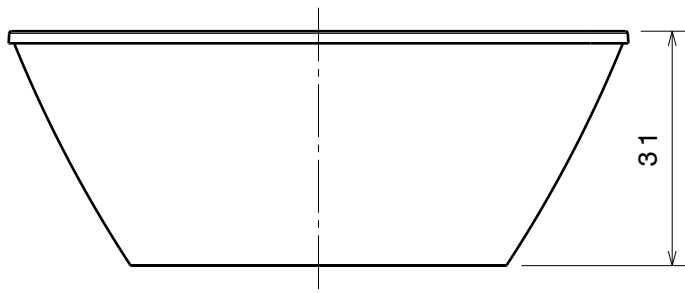

Detail B
Scale: 2:1

3

3

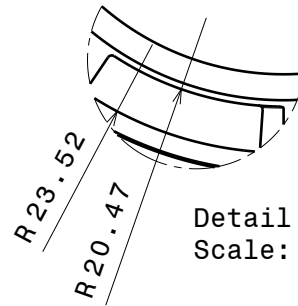
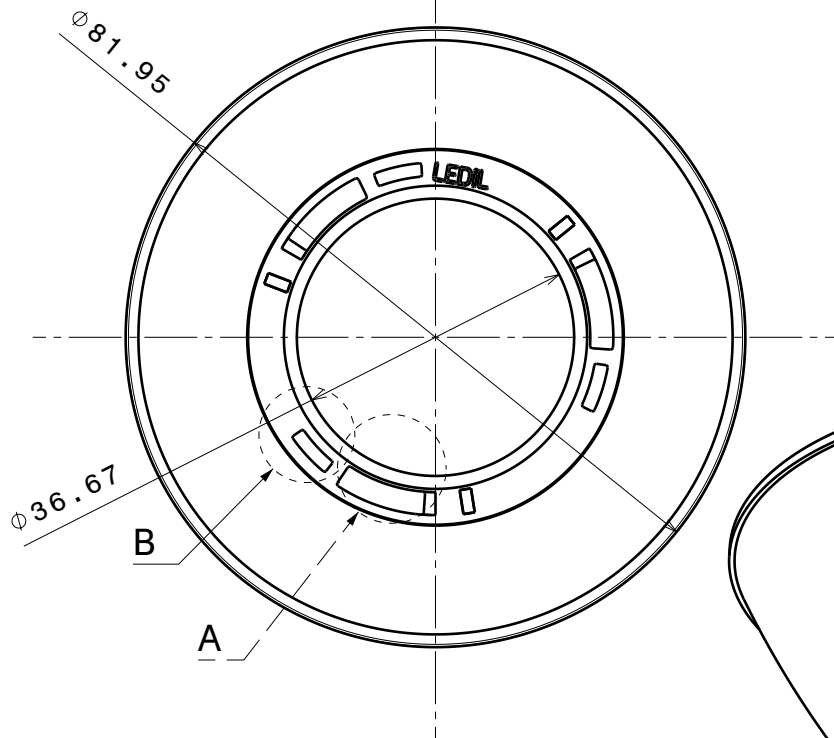

Detail A
Scale: 2:1

2

2

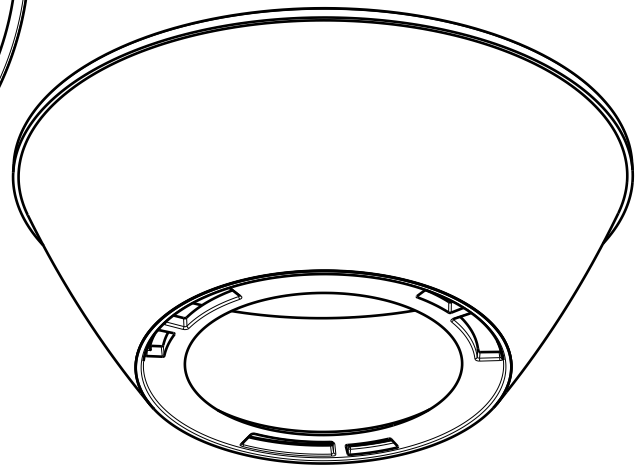

INDEX	PART NO	DESCRIPTION	MATERIAL	COLOUR
1		ANGELINA	PC	metal

Tolerances if not otherwise shown
According to DIN ISO 2768-1
Linear measures:
Up to 30mm class M, otherwise class C.
According to DIN ISO 2768-2
Form and position: class L

LEDiL
Ledil Oy
Salorankatu 10
FIN 24240 SALO
Finland

THIRD ANGLE PROJECTION:

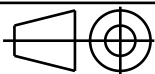

DRAWING TITLE

ANGELINA series Reflector

This drawing is the property of LEDiL Oy. It may not be reproduced, copied or communicated without a written agreement with LEDiL Oy."

SIZE PART NUMBER

A4

-

SCALE 1:1 WEIGHT

-

SHEET 1/1

D

A

1

Luminaire: LEDiL Oy F13401_ANGELINA-M_(BXRA_ES) Eff.92.6%

Lamps: 1 x BXRA_ES_(BXRA-W1203_102820-3110)_281.549lm@250mA_P=4.09397W_I=249.8mA

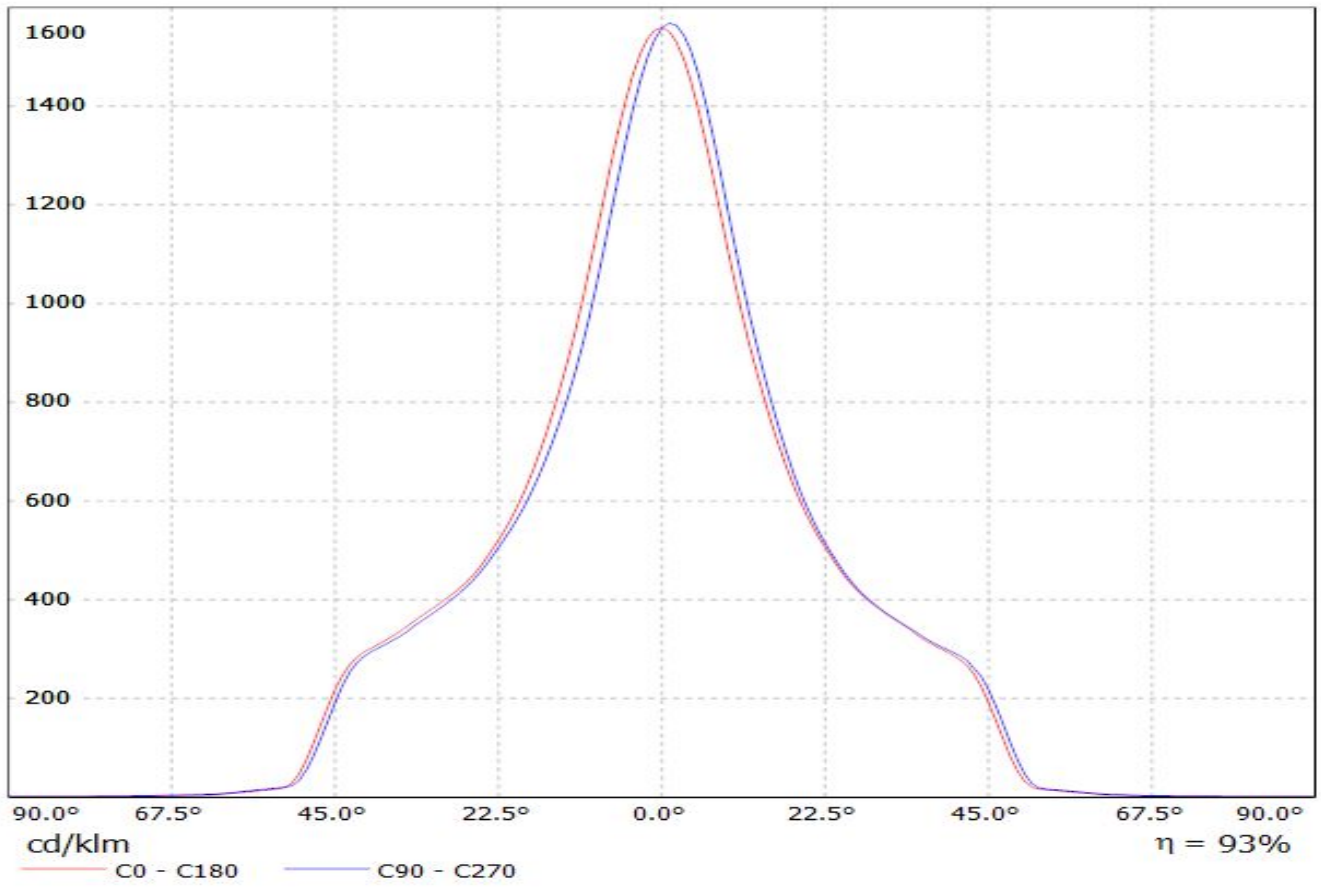

QUESTION 10 (of 10) [QUESTION] [ANSWER] [MARKS] [REVIEW] [DELETE] [FLAG]

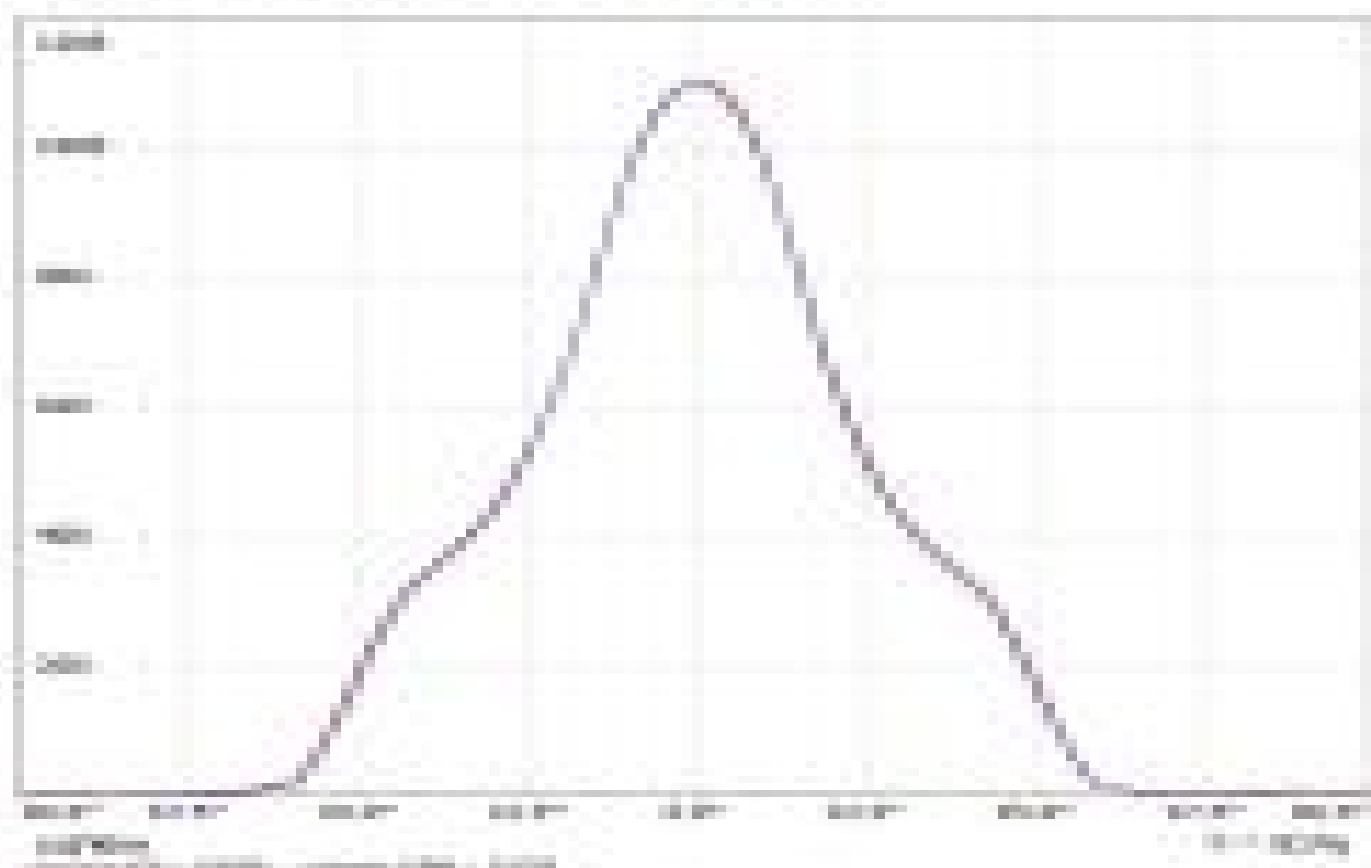

Luminaire: LEDiL Oy F13401_ANGELINA-M_(V13_Gen7)+TE

Lamps: 1 x Bridgelux_V13_Gen7_(BXRE-30E2000-B_+TE_2213254-2+TE_2213194-1)_1295.55lm@250mA_P=8.30985W_η=0.25A

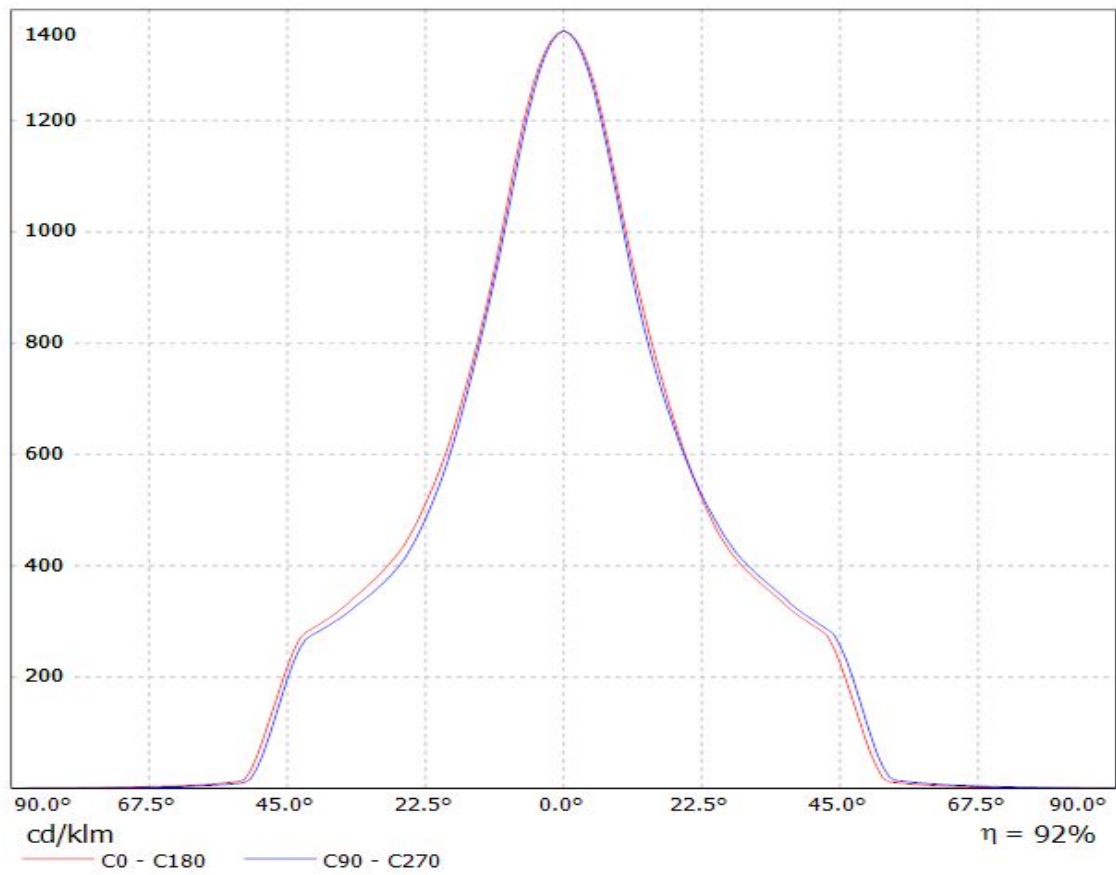

Luminaire: Ledil Oy F13401_ANGELINA-M_Bridgelux_V22_Gen7_SIMULATED F13401_ANGELINA-M_Bridgelux_V22_Gen7_SIMULATED
Lamps: 1 x F13401_ANGELINA-M_Bridgelux_V22_Gen7_SIMULATED

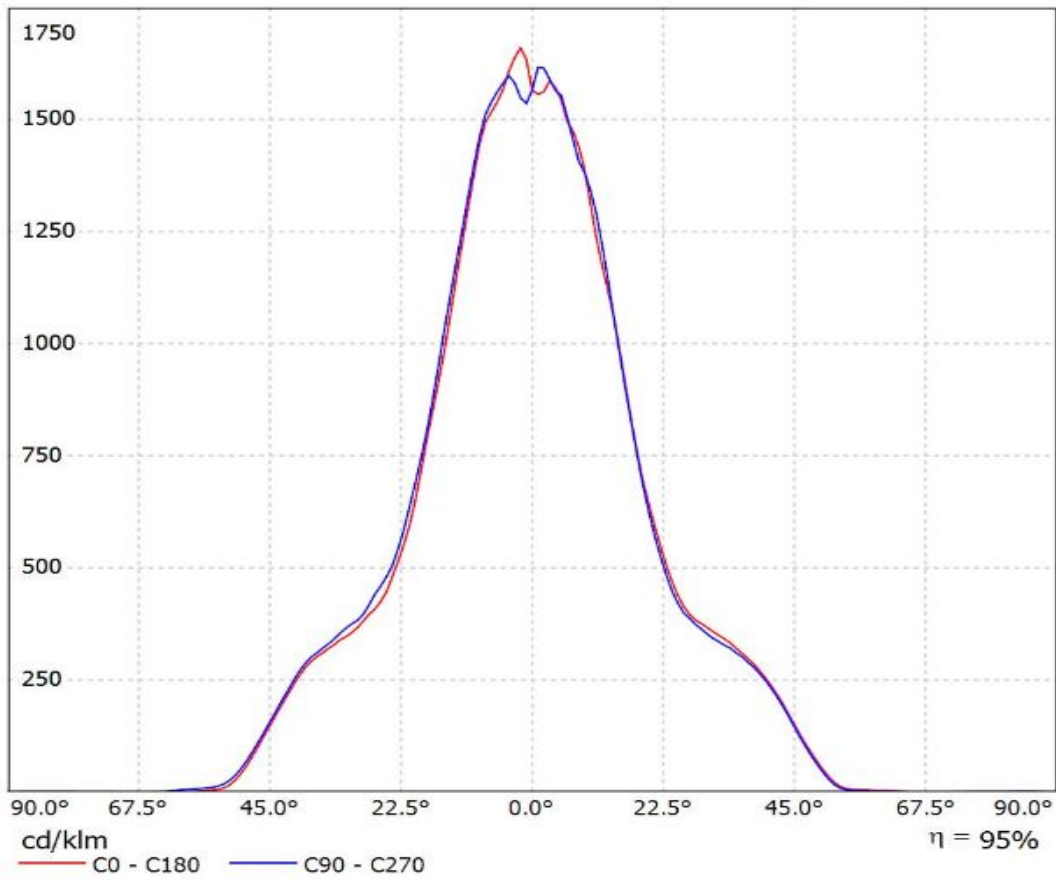

Luminaire: LEDiL Oy F13401_ANGELINA-M_(CLL030) Eff.92.3%

Lamps: 1 x CITIZEN_CLL030_(CLL030-1205A5-303H1A7)_758.588lm@250mA_CCT=5090K_P=8.61086W_I=249.8mA

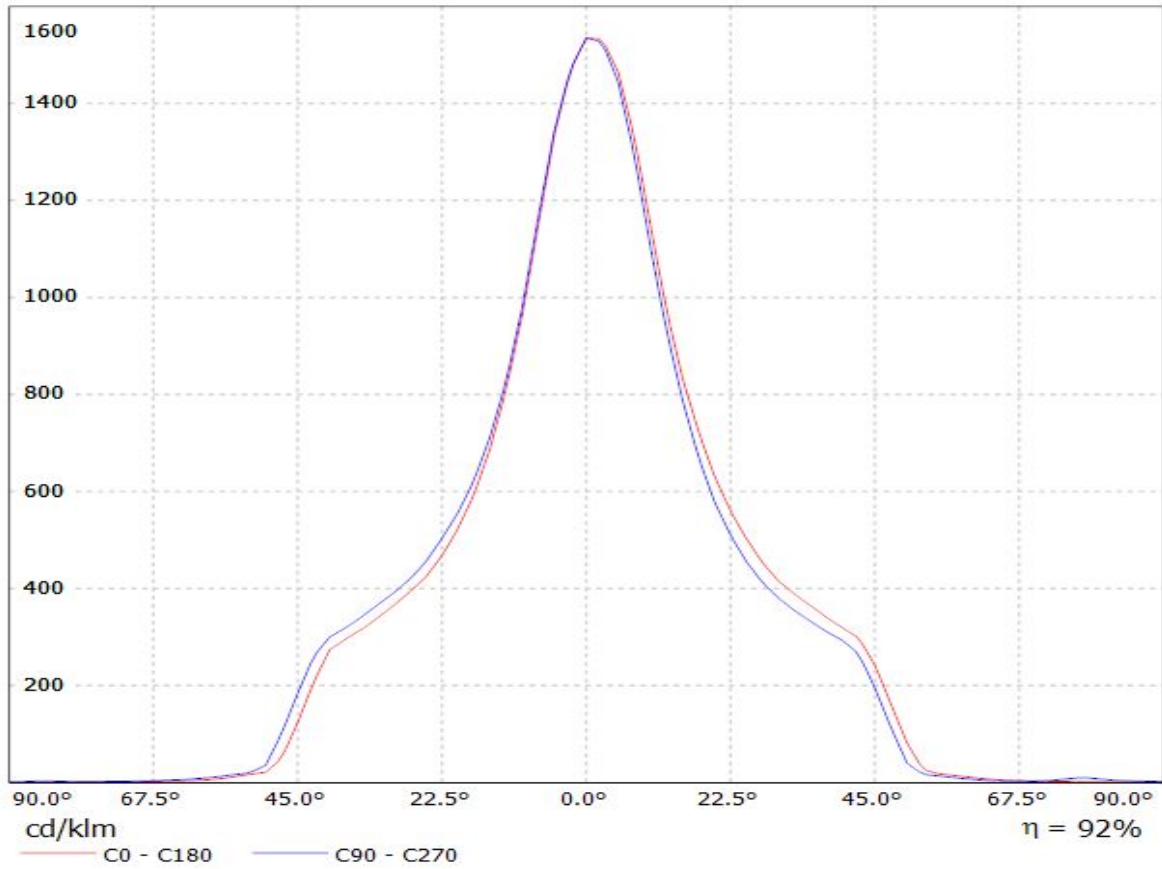

Luminaire: LEDiL F13401_ANGELINA-M_(CLL030)

Lamps: 1 x CLL030 740lm@250mA (CLL030-1205A5-303H1A7) CCT:3000K P:8.6W

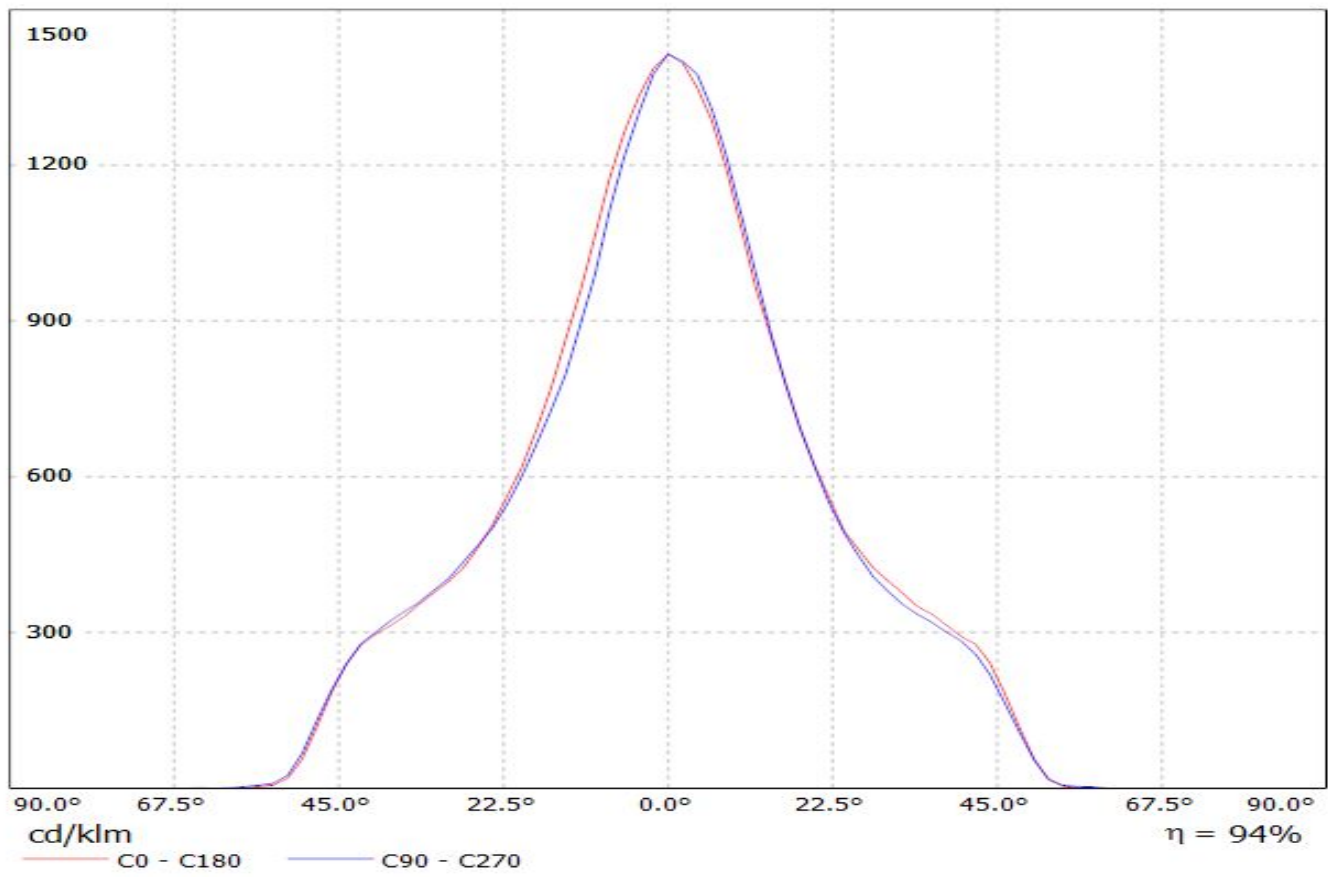

Luminaire: Ledil F13401_ANGELINA-M_(CLU720)
Lamps: 1 x CITIZEN_CLU720_(CLU720-1206B8-273M2)
_1337.27lm@250mA_CCT=2700K_P=8.35W_I=0.25A

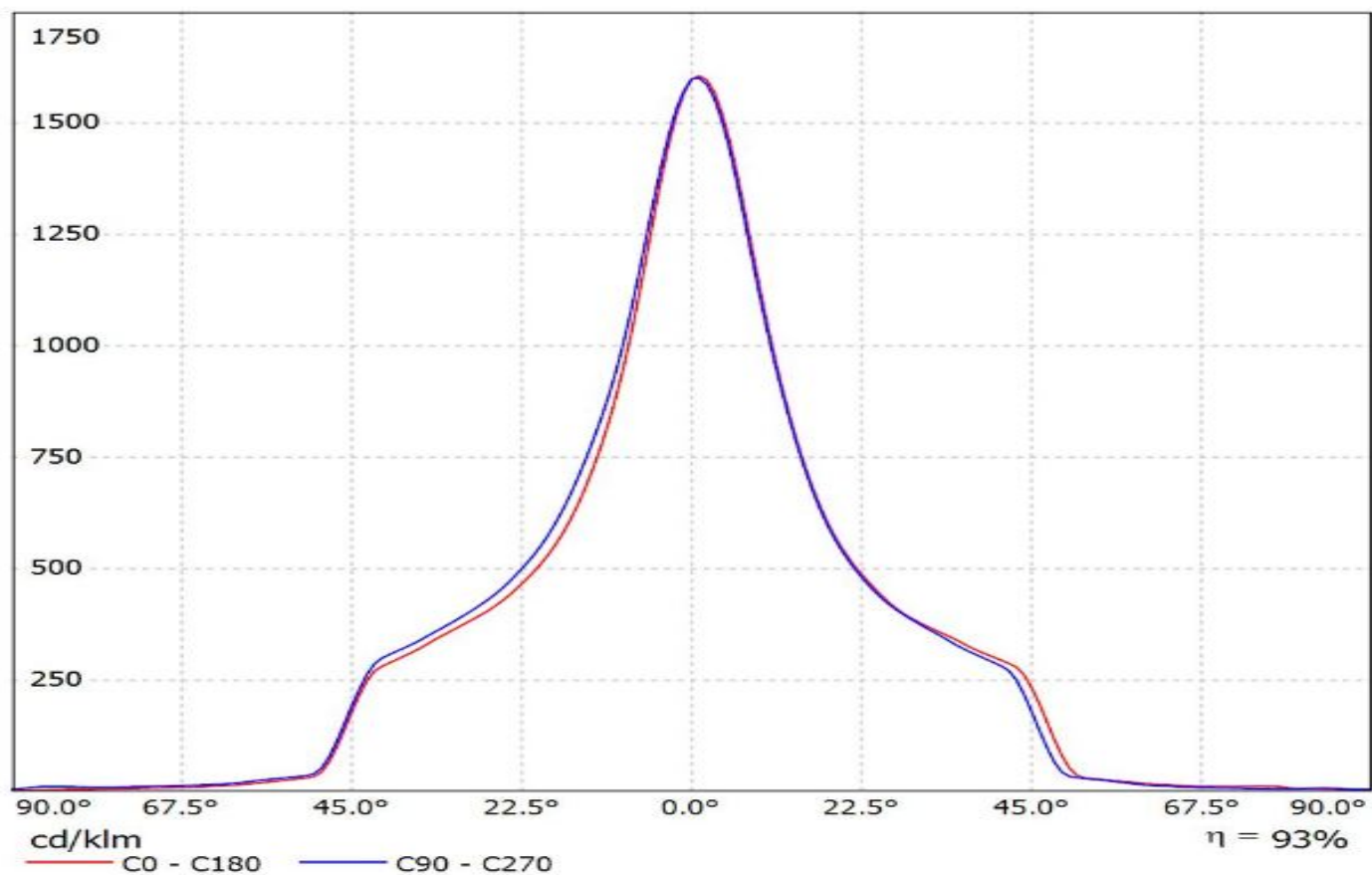

Ledil F13401_ANGELINA-M_(CLU720) / LDC (Linear)

Luminaire: Ledil F13401_ANGELINA-M_(CLU720)
Lamps: 1 x CITIZEN_CLU720_(CLU720-1206B8-273M2)
_1340.38lm@250mA_CCT=2700K_P=8.35W_I=0.25A

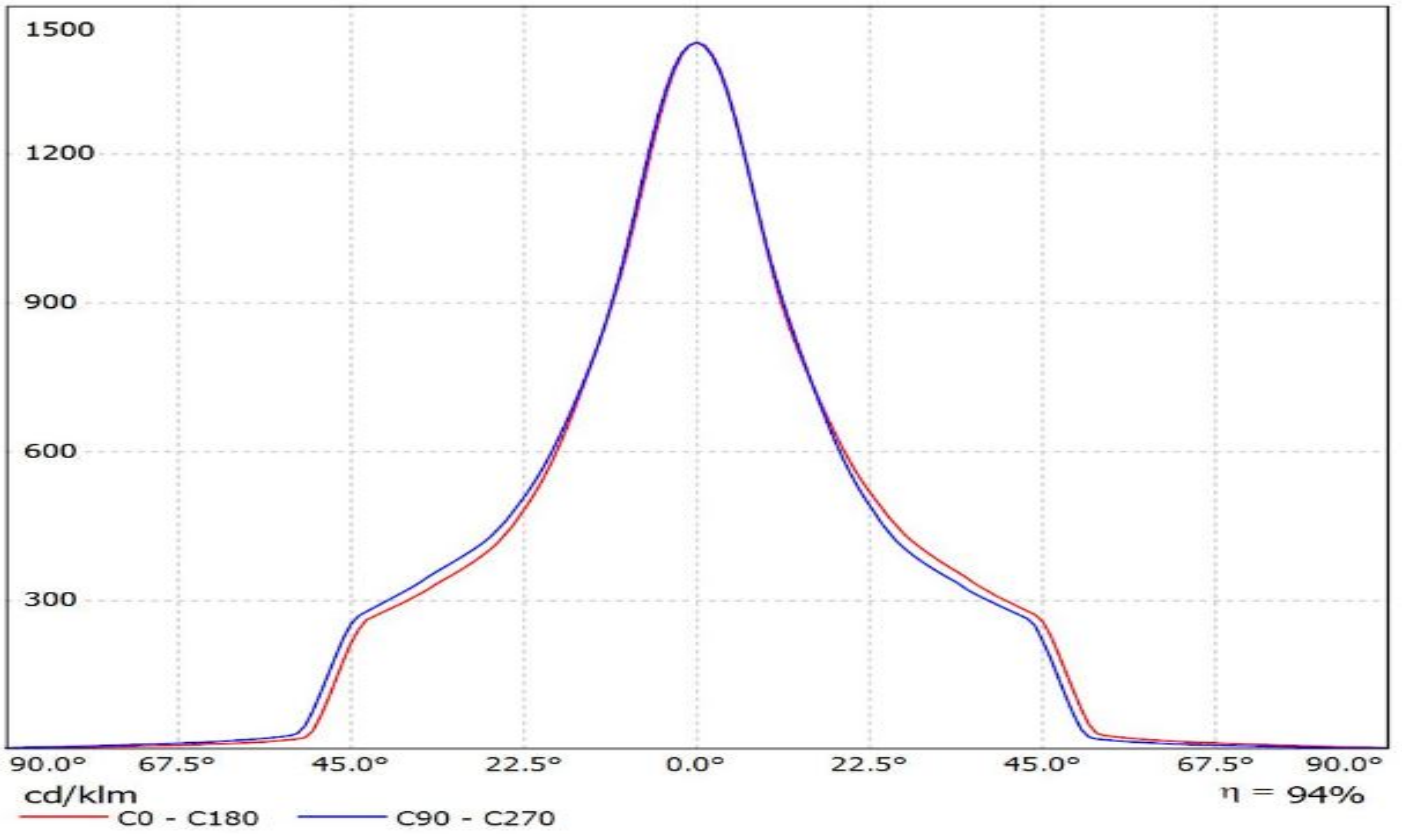

Luminaire: Ledil F13401_ANGELINA-M_(CLU046+IDEAL)

Lamps: 1 x Citizen_CLU046_(-1212C1-303M2G2)_1383.92lm@250mA_CCT=3000K_P=8.122W_I=0.25A

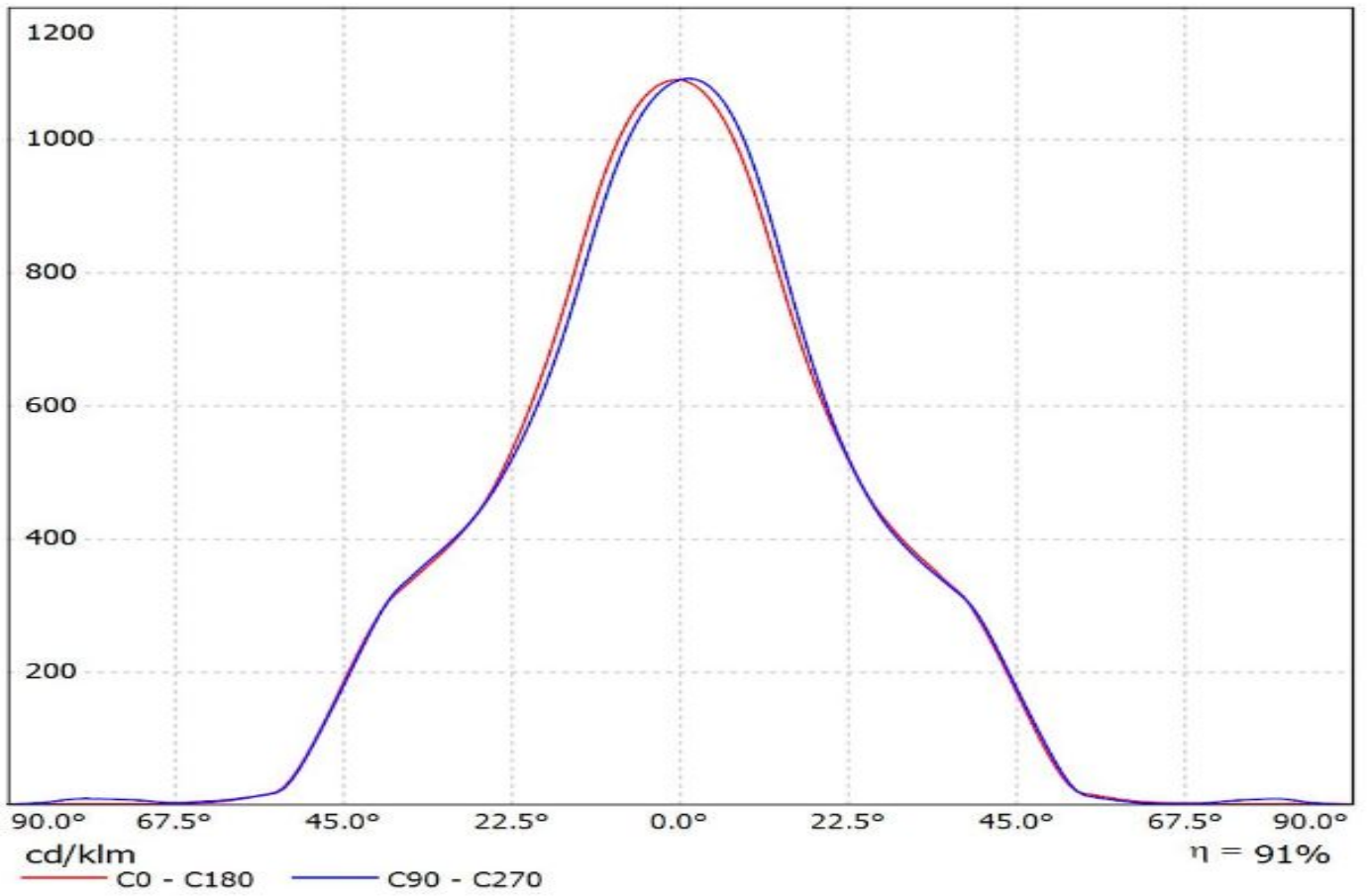

Luminaire: Ledil F13401_ANGELINA-M (CLU730+IDEAL)

Lamps: 1 x Citizen_CLU730_(-1210B8-273M2G1)_IDEAL_50-2204C+50-2100AN

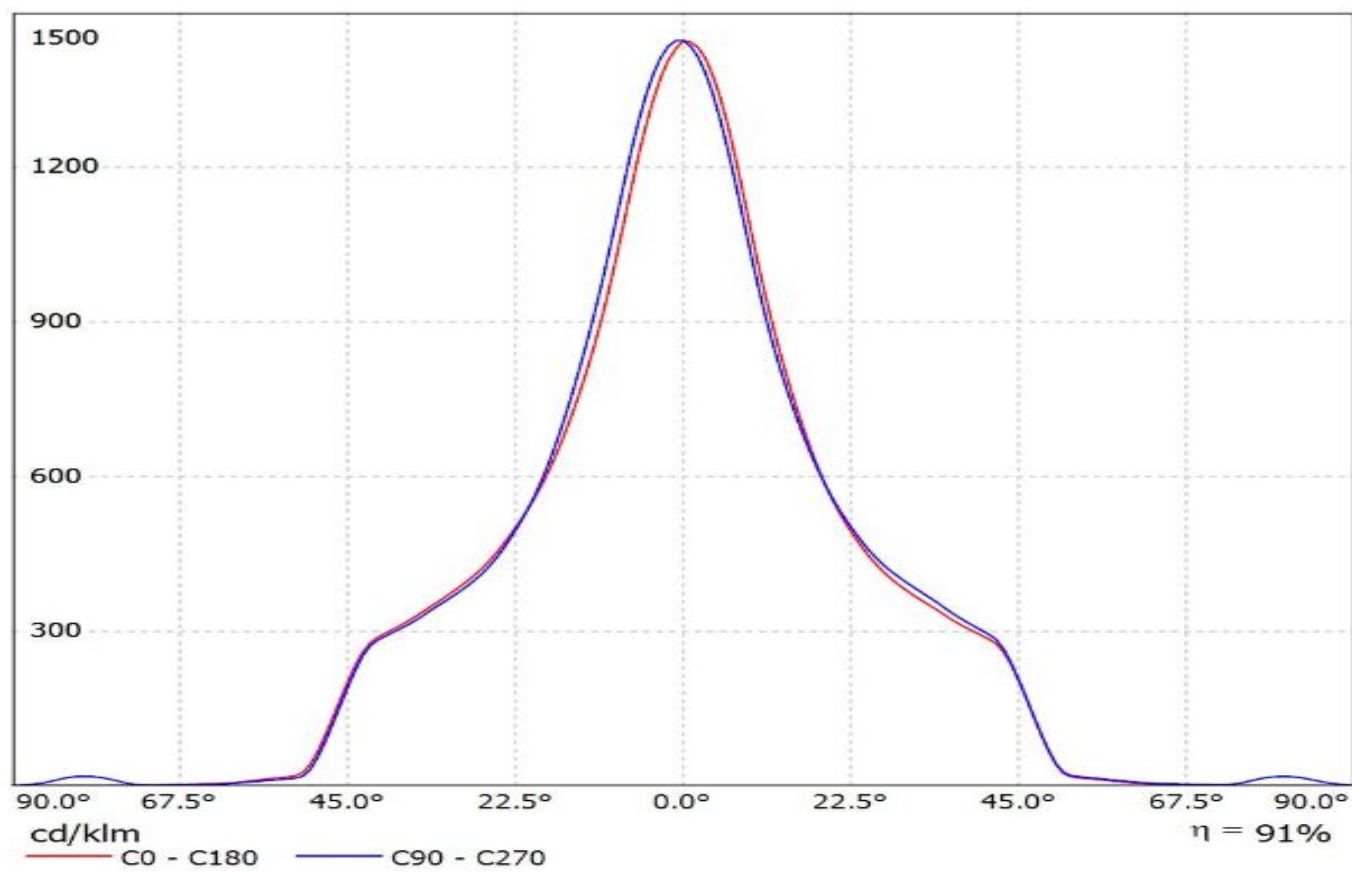

Luminaire: LEDiL Oy F13401_ANGELINA-M_(CXA25) Eff.93.0%

Lamps: 1 x CREE_CXA25_(CXA2530-7C0-T2-N0H)_1151.98lm@250mA_CCT=3000K_P=8.4892W_I=249.8mA

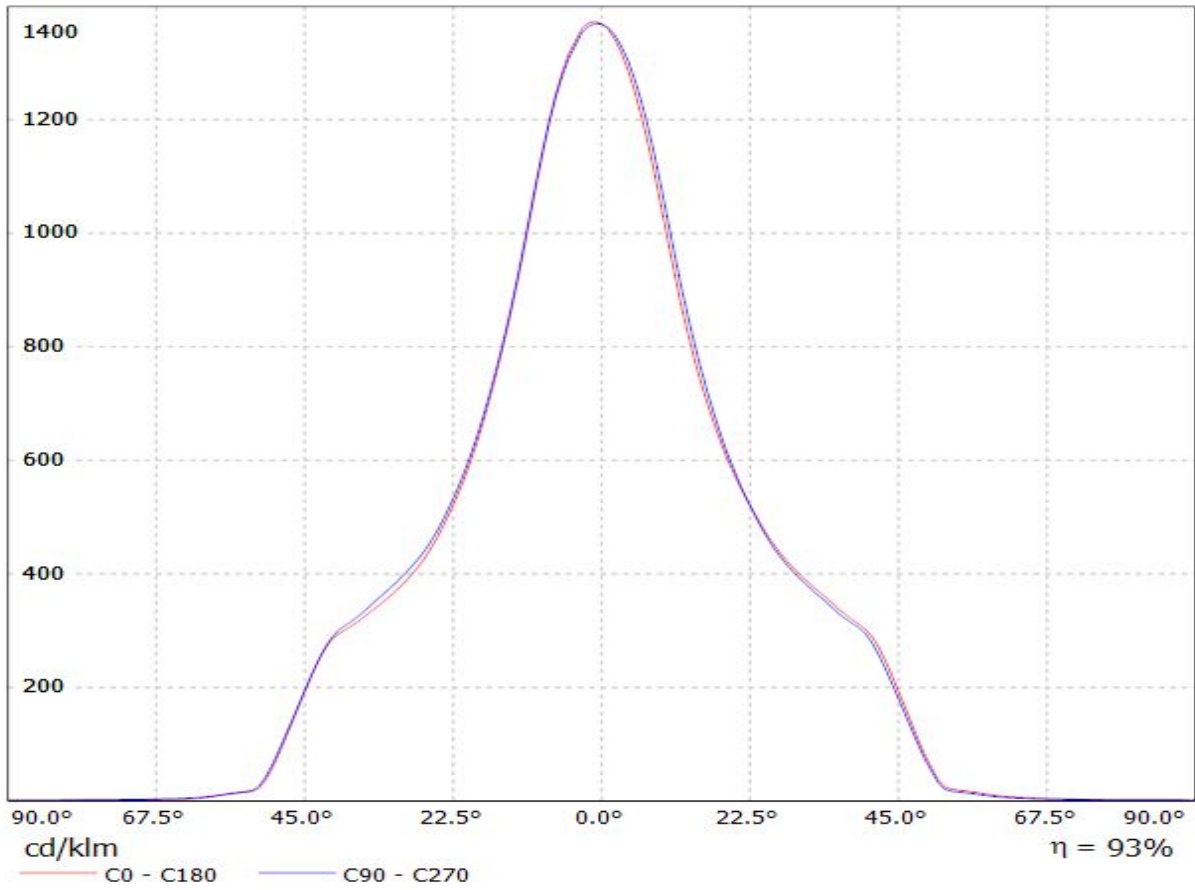

Luminaire: LEDiL Oy F13401_ANGELINA-M_(CXA30) Eff. 93%
Lamps: 1 x CREE_CXA30_(CXA3050-3C0-Y2-N0H)_1340.66lm@250mA_P=8.16471W_CCT=5000K_I=249.8mA

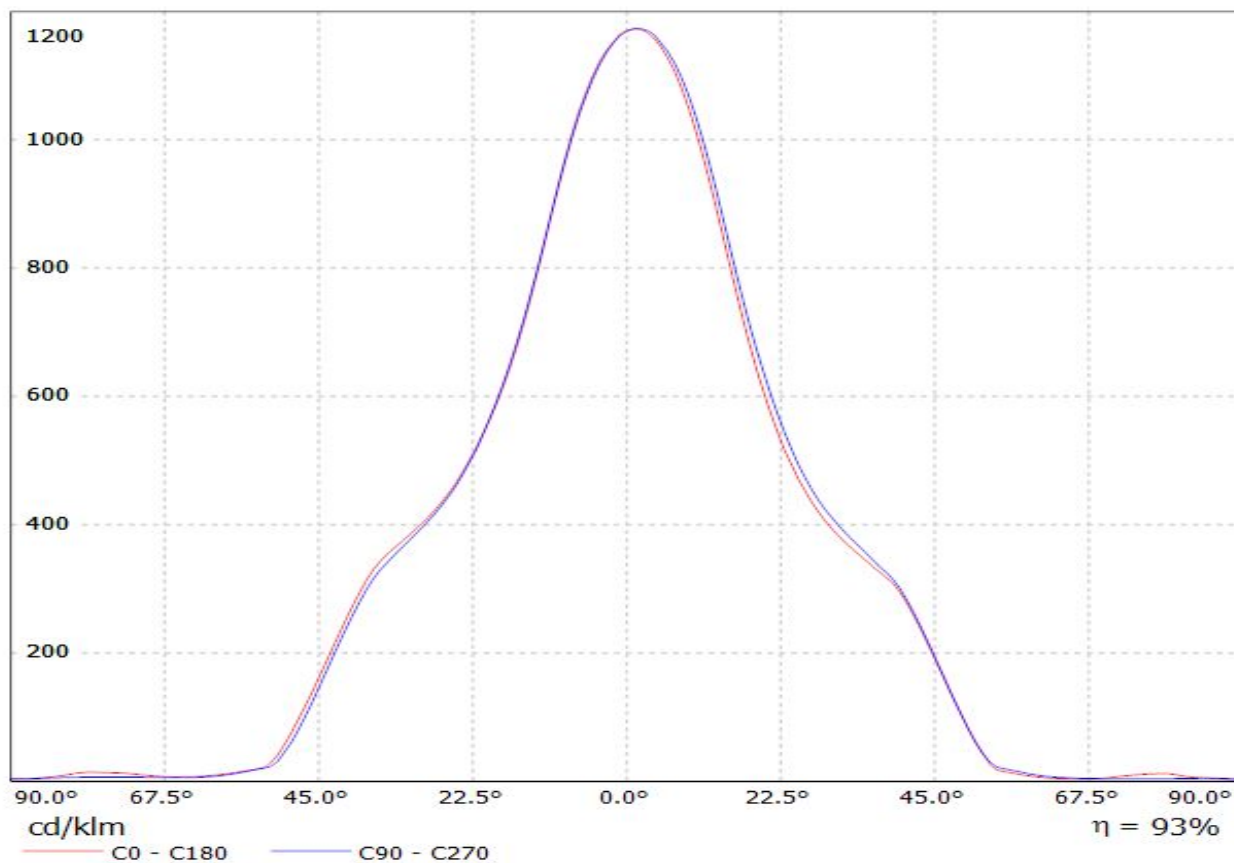

Luminaire: LEDiL Oy F13401_ANGELINA-M_(CXA1816) Eff. 93%
Lamps: 1 x CREE_CXA1816_1042.78lm@250mA_P=8.65157W_I=249.9mA

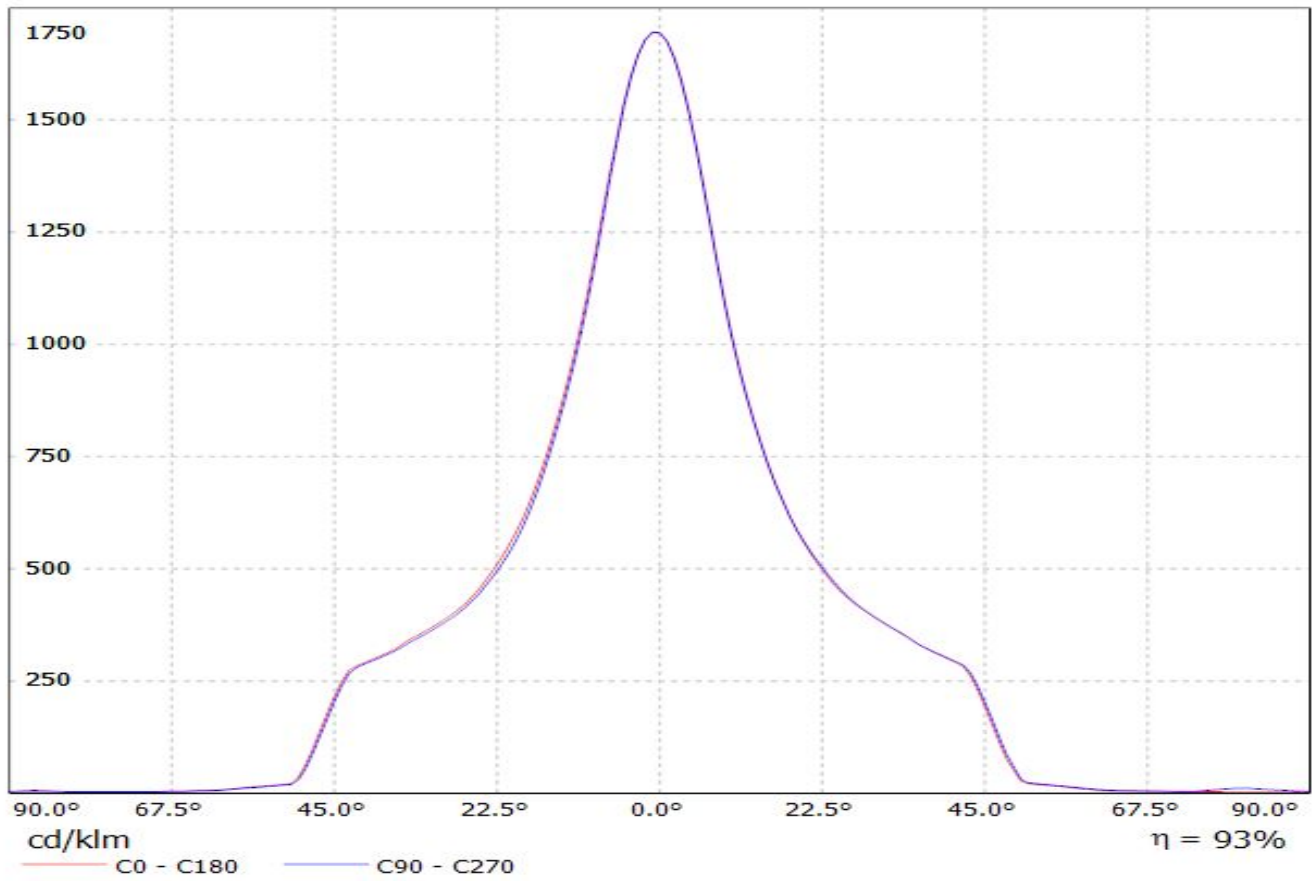

Luminaire: LEDiL Oy F13401_ANGELINA-M_(CXA3590)

Lamps: 1 x CREE_CXA3590_(CXA3590-30F-BD-R0H-0002)_2640.14lm@250mA_CCT=3000K_P=16.3941W_I=249.8mA

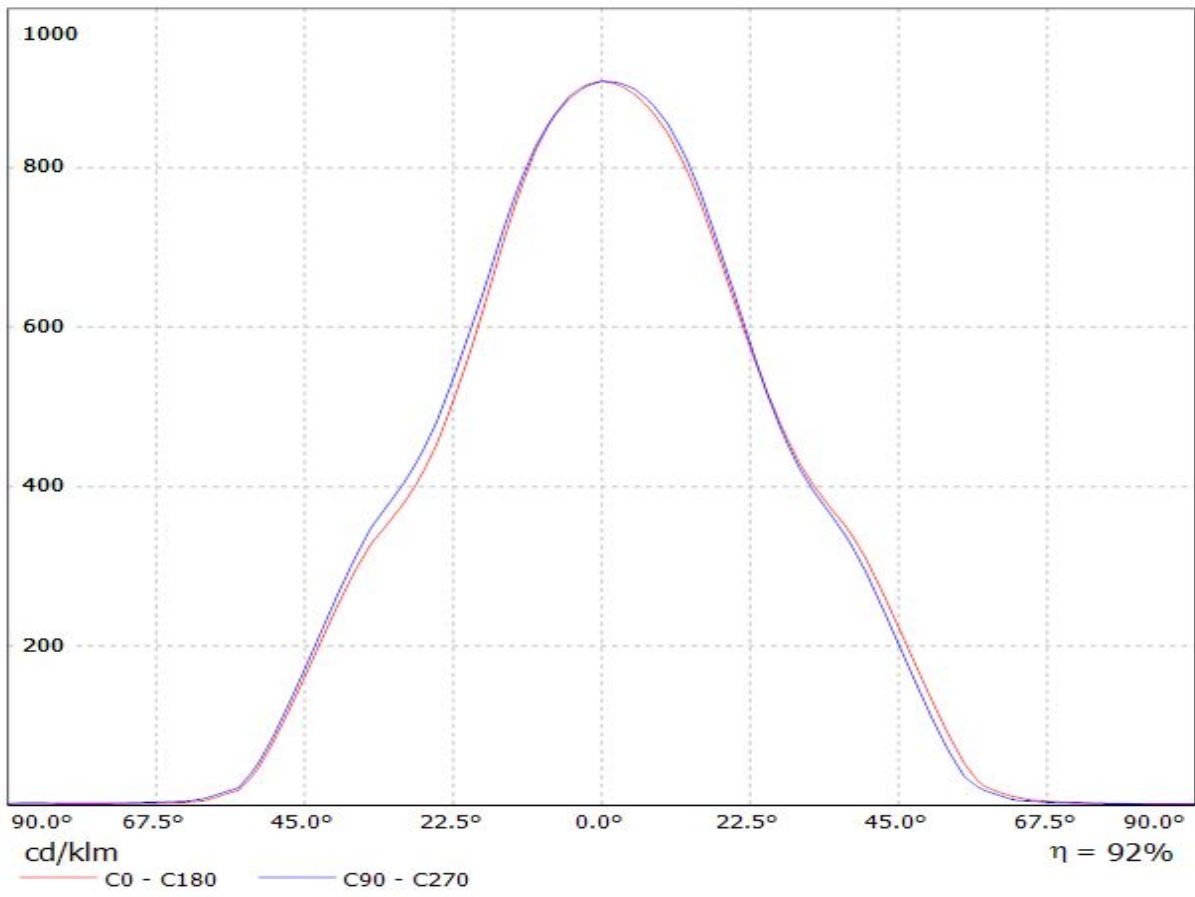

Luminaire: LEDiL Oy F13401_ANGELINA-M_(LG_COB-10W) Eff.92.4%
Lamps: 1 x LG_COB-10W_1024lm@250mA_CCT=5090K_P=9W_I=250mA

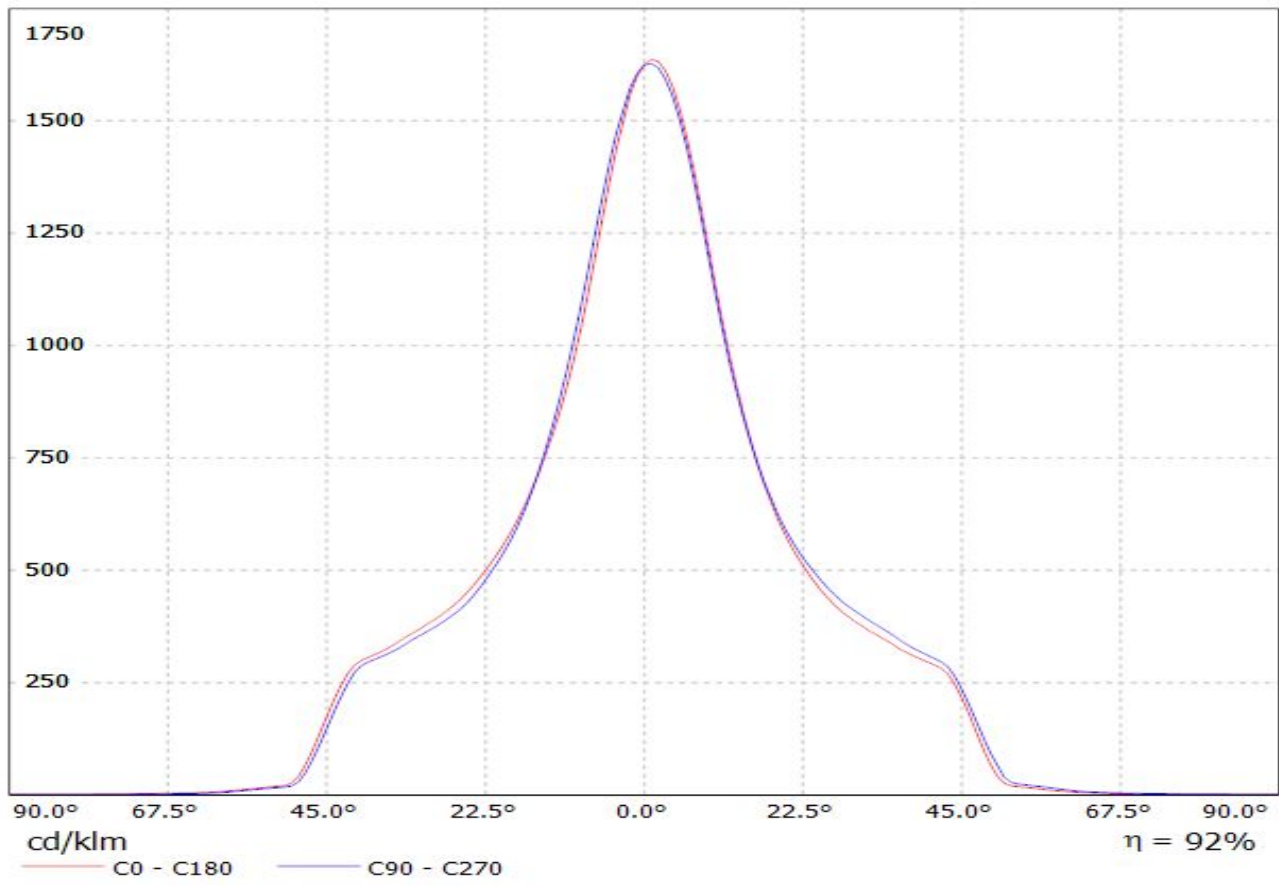

LEDiL Oy C13401_ANGELINA-M_(LUXEON_K16) Eff.93.6% / LDC (Linear)

Luminaire: LEDiL Oy C13401_ANGELINA-M_(LUXEON_K16) Eff.93.6%
Lamps: 1 x LUXEON_K16 (1204.33lm@250mA)

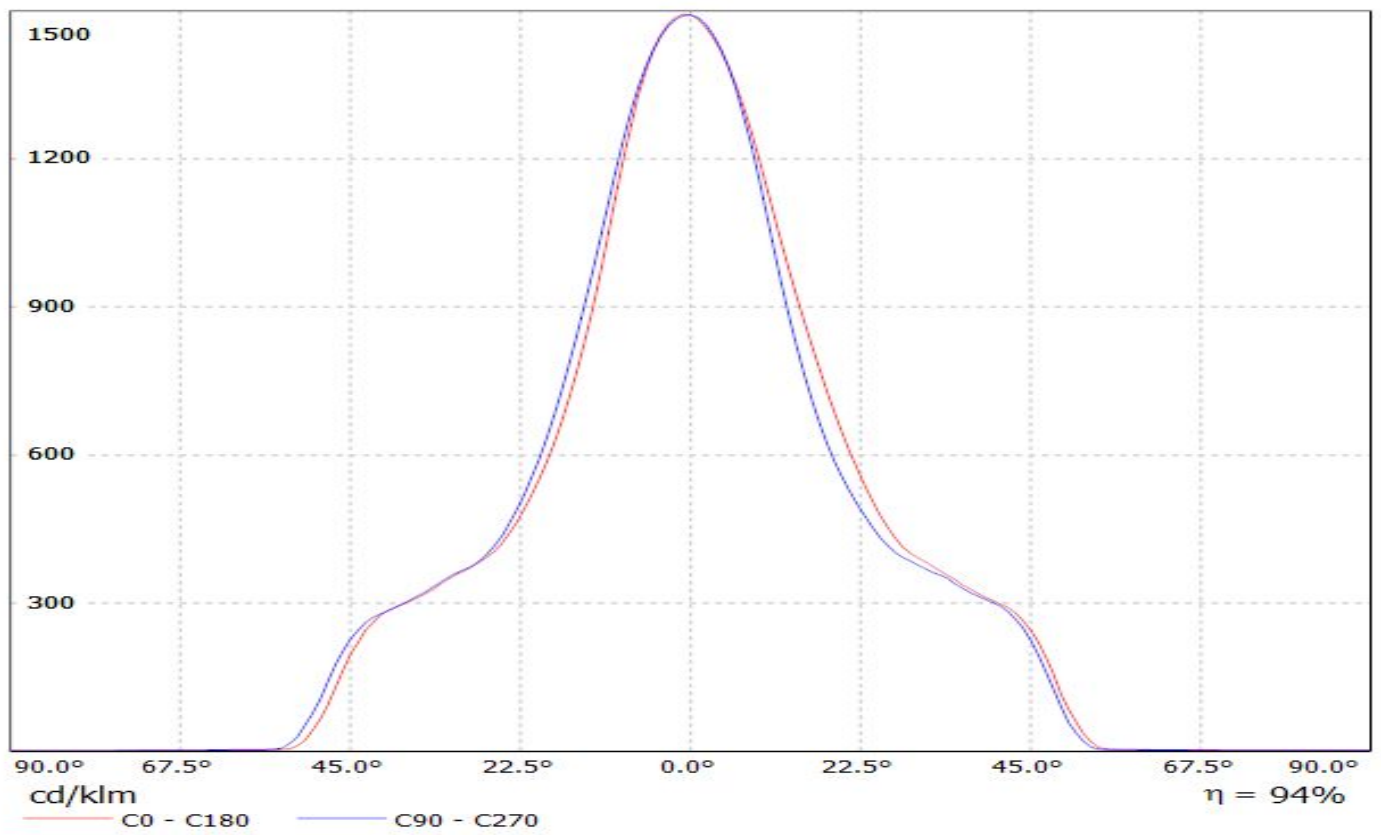

LEDiL Oy C13401_ANGELINA-M_(LUXEON_K12) Eff.94.0% / LDC (Linear)

Luminaire: LEDiL Oy C13401_ANGELINA-M_(LUXEON_K12) Eff.94.0%
Lamps: 1 x LUXEON_K12 (929.543lm@250mA)

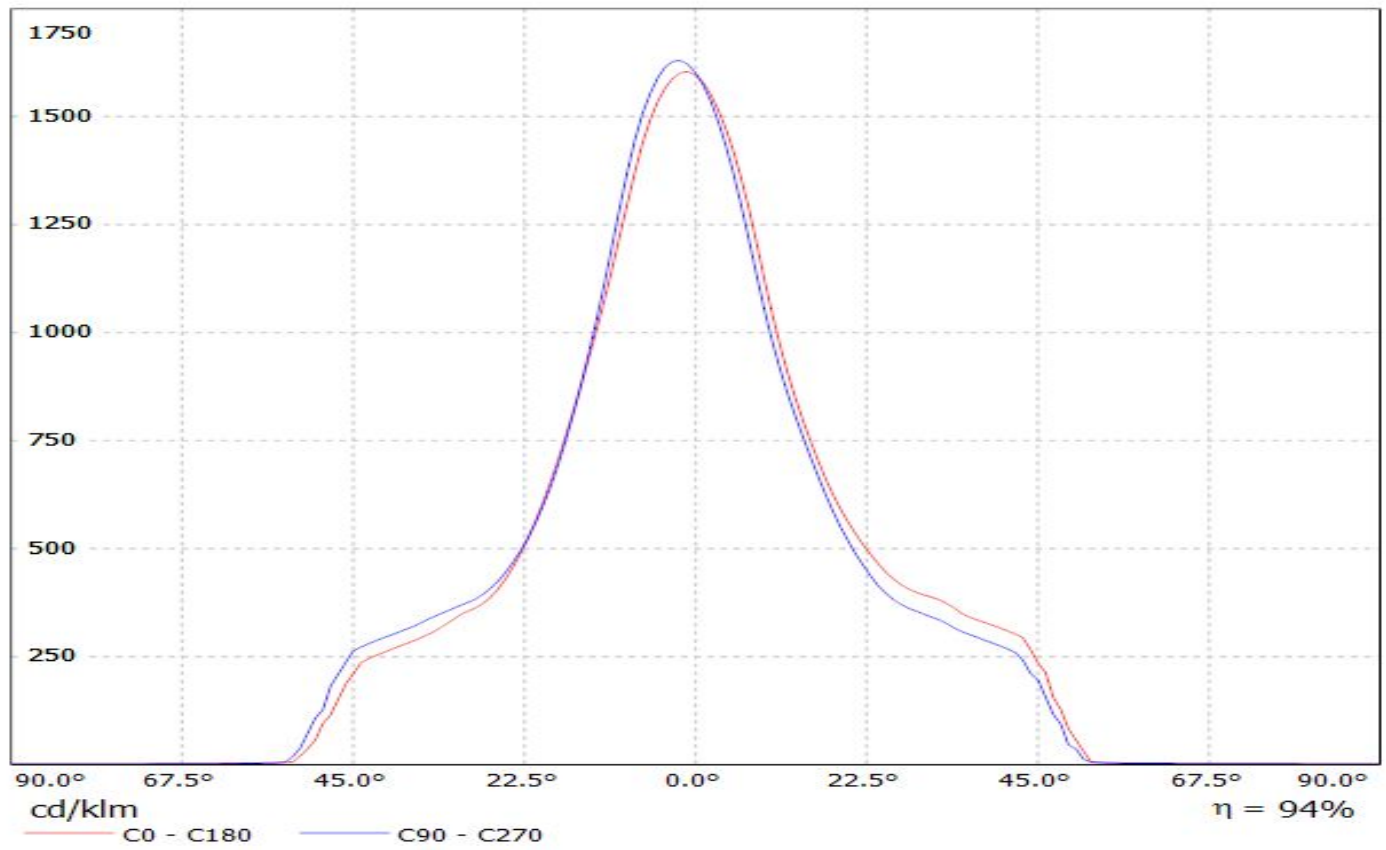

Luminaire: LEDiL Oy F13401_ANGELINA-M_(LUXEON_CoB_1205) Eff. 94 %
Lamps: 1 x LUXEON CoB 1205 (LHC1-3080-1205) 1082lm@250mA CCT=3000K P=8.3W I=250mA

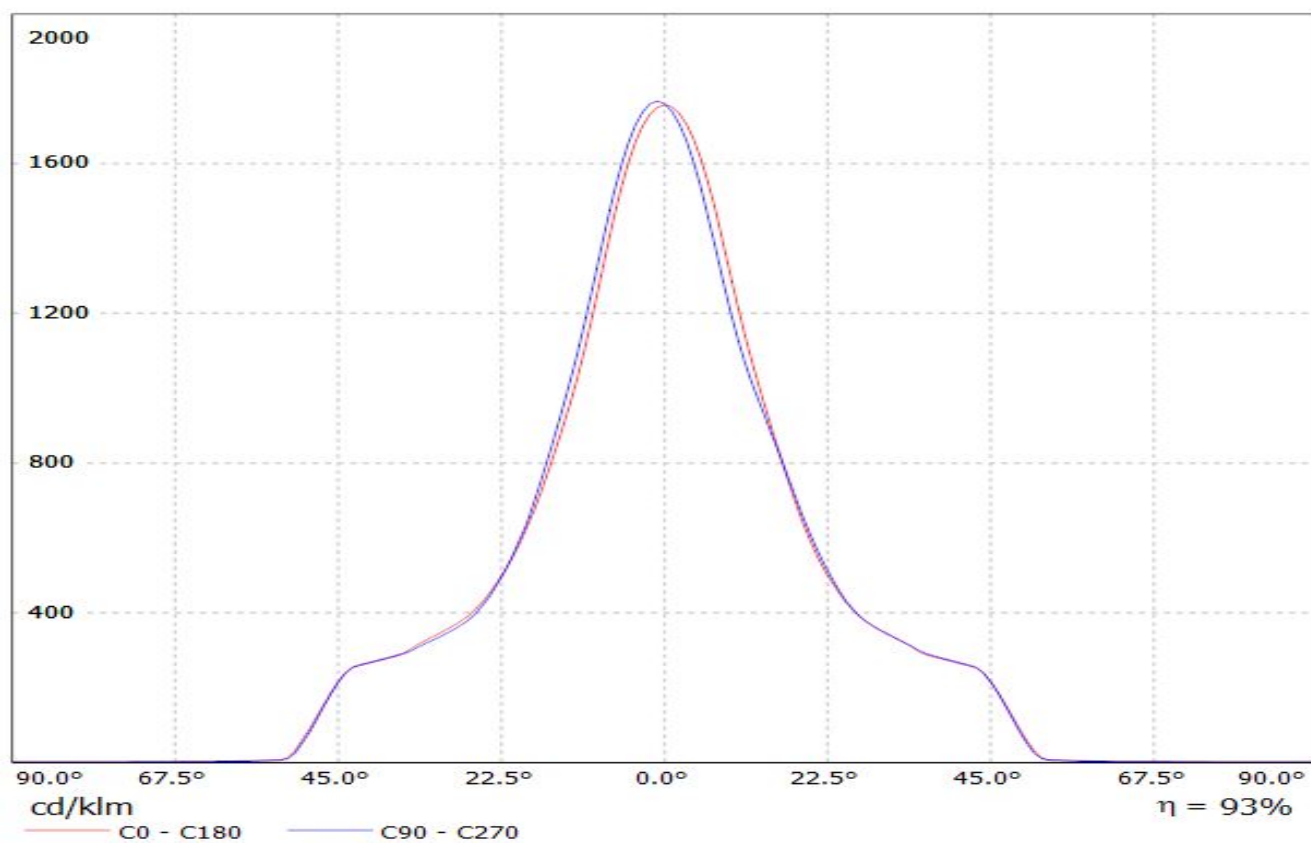

Luminaire: LEDiL Oy F13401_ANGELINA-M_(LUXEON_CoB_1208) Eff: 93 %
Lamps: 1 x Luxeon CoB 1208 (LHC1-3080-1208) 1029lm@250mA CCT=3000K P=8.2W I=250mA

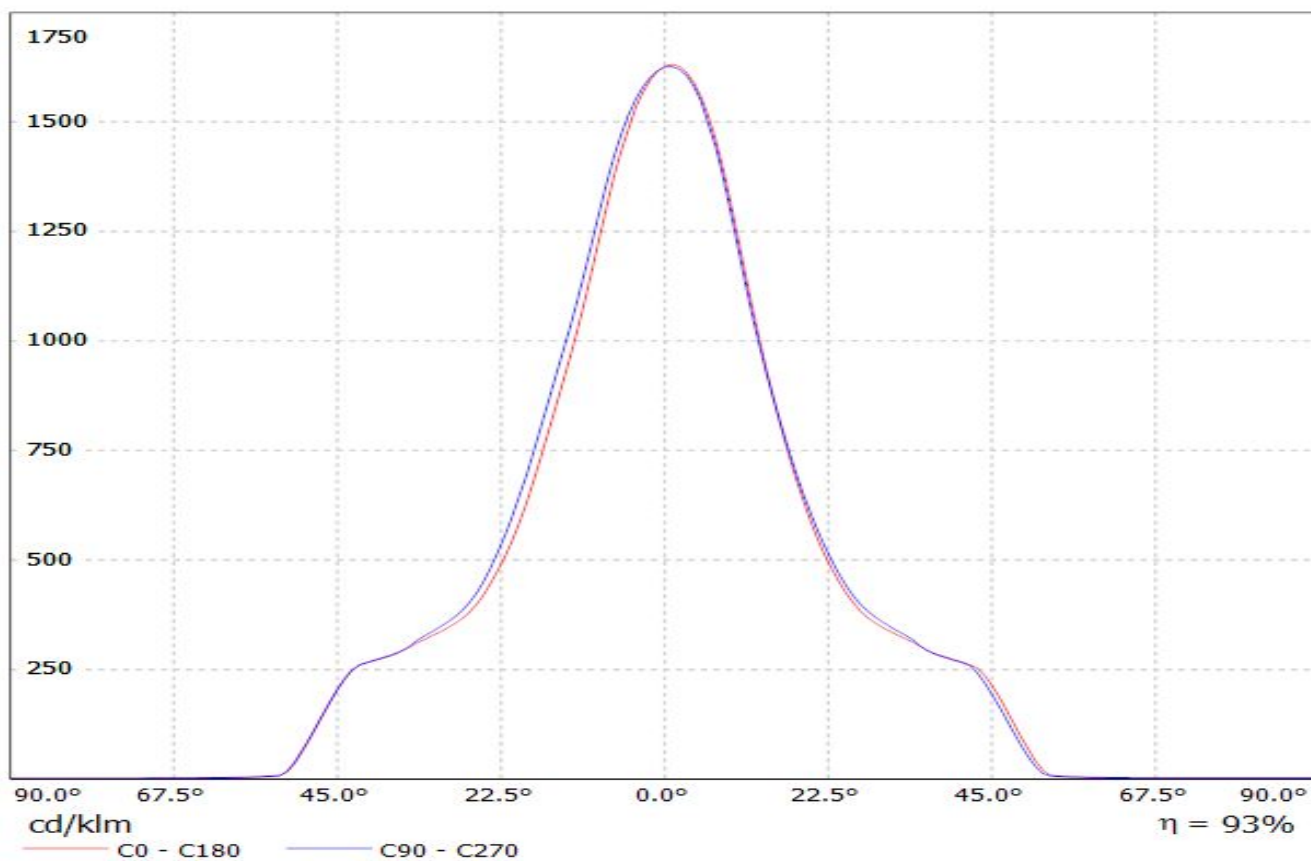

Luminaire: LEDiL Oy F13401_ANGELINA-M_(LUXEON_COB_1205) Eff.92.4%
Lamps: 1 x LUXEON_COB_1205_(LHC1-3080-1205)_1084.49lm@250mA_CCT=3000K_P=8.31784W_I=249.8mA

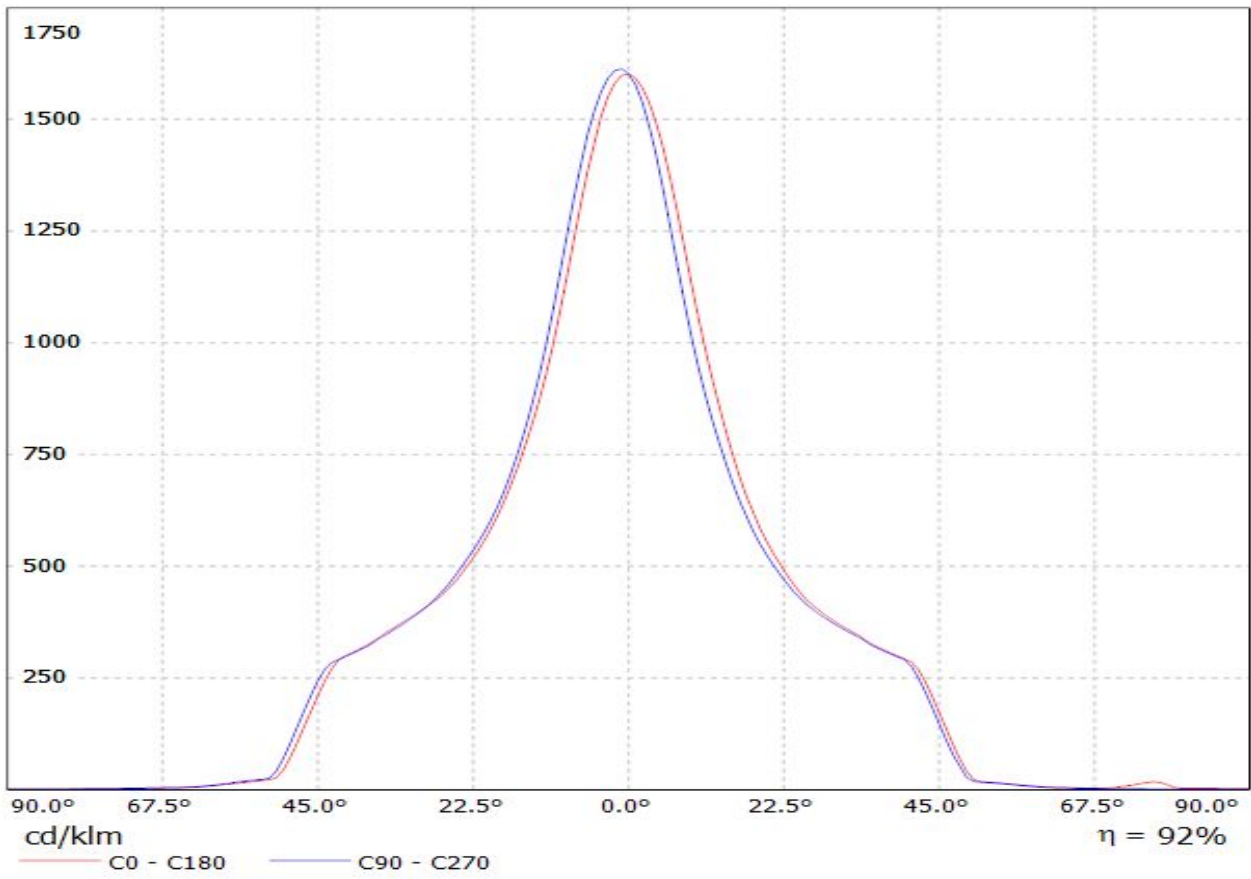

Luminaire: LEDiL Oy F13401_ANGELINA-M_(LUXEON_COB_1208) Eff.92.5%
Lamps: 1 x LUXEON_COB_1208_(LHC1-3080-1208)_1015.13lm@250mA_CCT=3000K_P=8.15972W_I=249.8mA

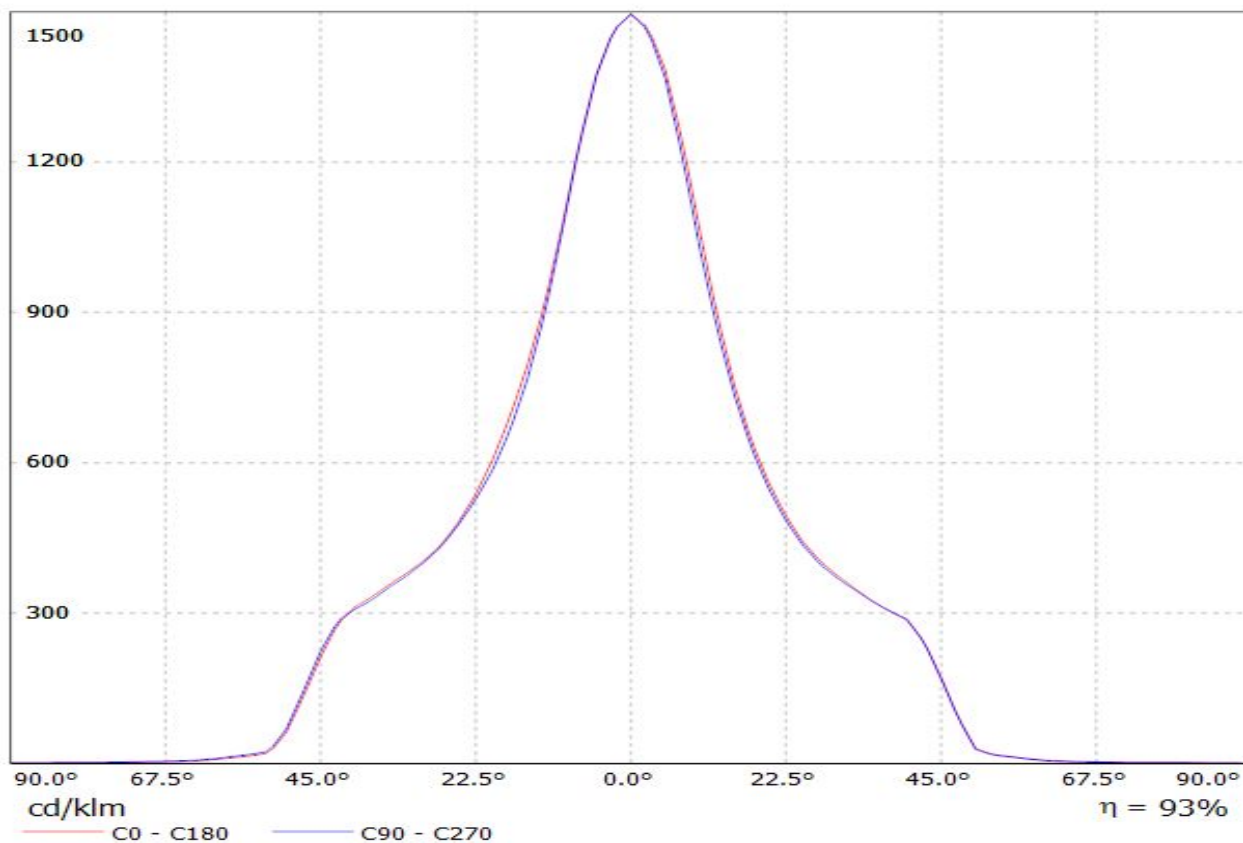

Luminaire: LEDiL Oy F13401_ANGELINA-M_(CXM-14)
Lamps: 1 x LUMINUS_CXM-14_1114.36lm@250mA_P=8.36106W_I=249.8mA

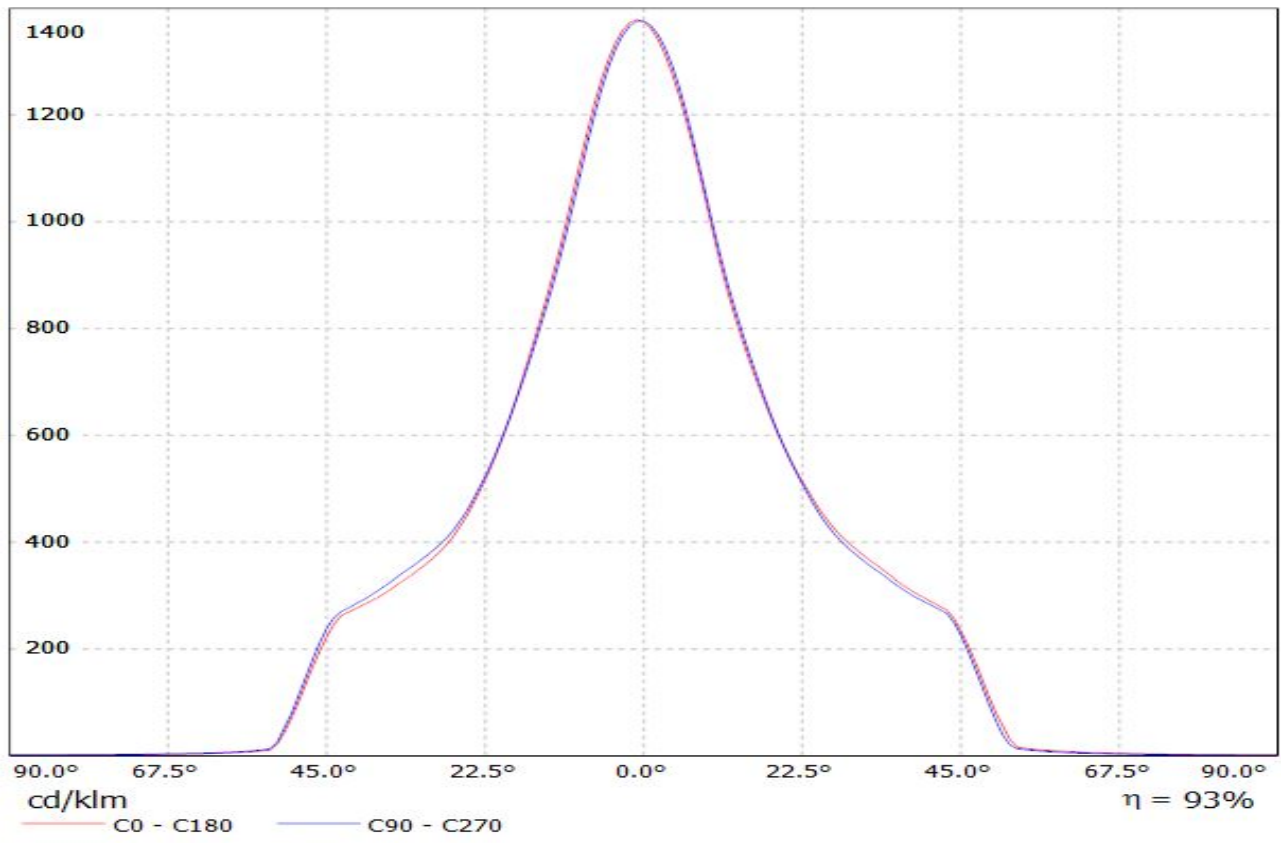

Luminaire: LEDiL Oy F13401_ANGELINA-M_(NSCxJ216A) Eff.93.5%
Lamps: 1 x NICHIA_NSCxJ216A_(NSCLJ216AE)_949.847lm@250mA_CCT=3000K_P=7.96937W_I=249.8mA

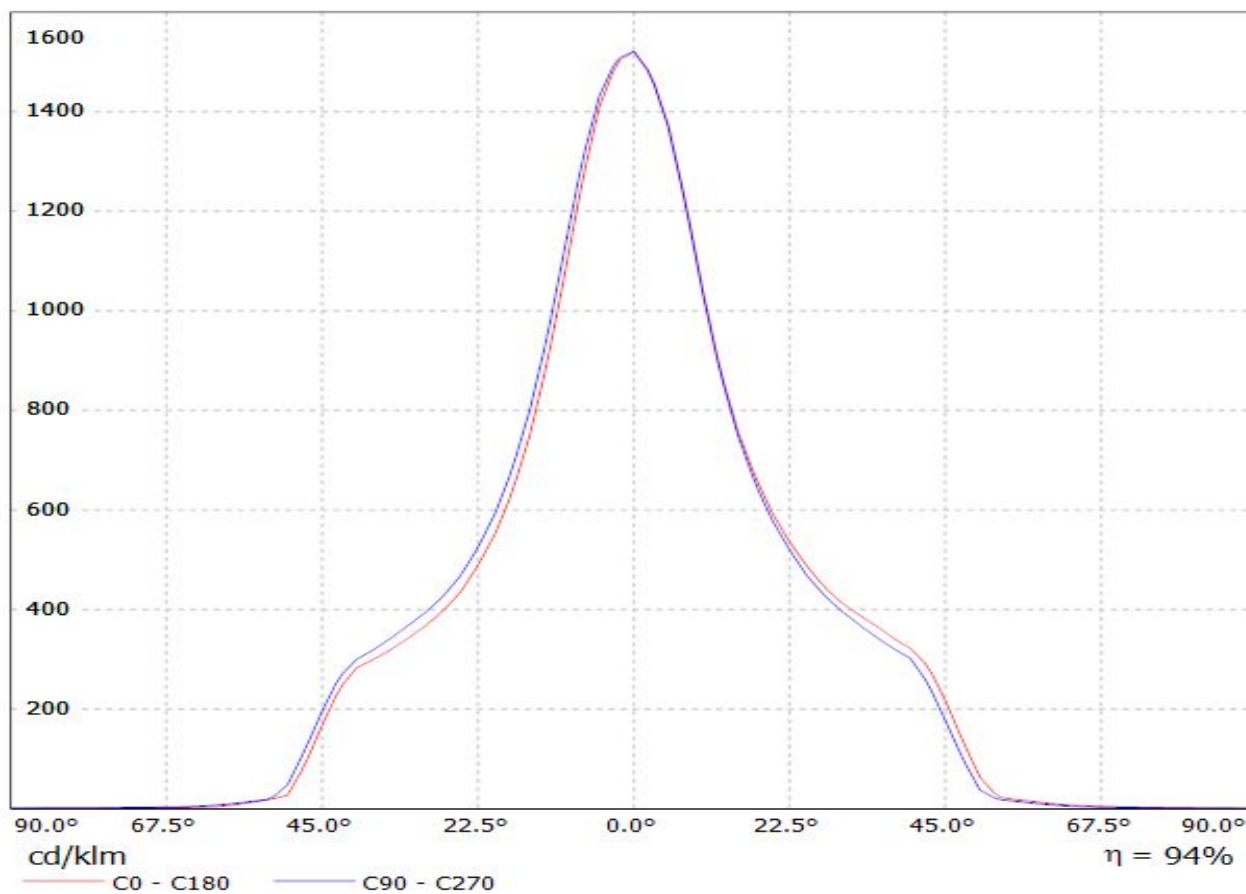

Luminaire: LEDiL Oy F13401_ANGELINA-M_(NSBxL121A) Eff.90.8%
Lamps: 1 x NICHIA_NSBxL121A_(NSBLL121AE)_805.561lm@250mA_CCT=3000K_P=7.3681W_I=249.8mA

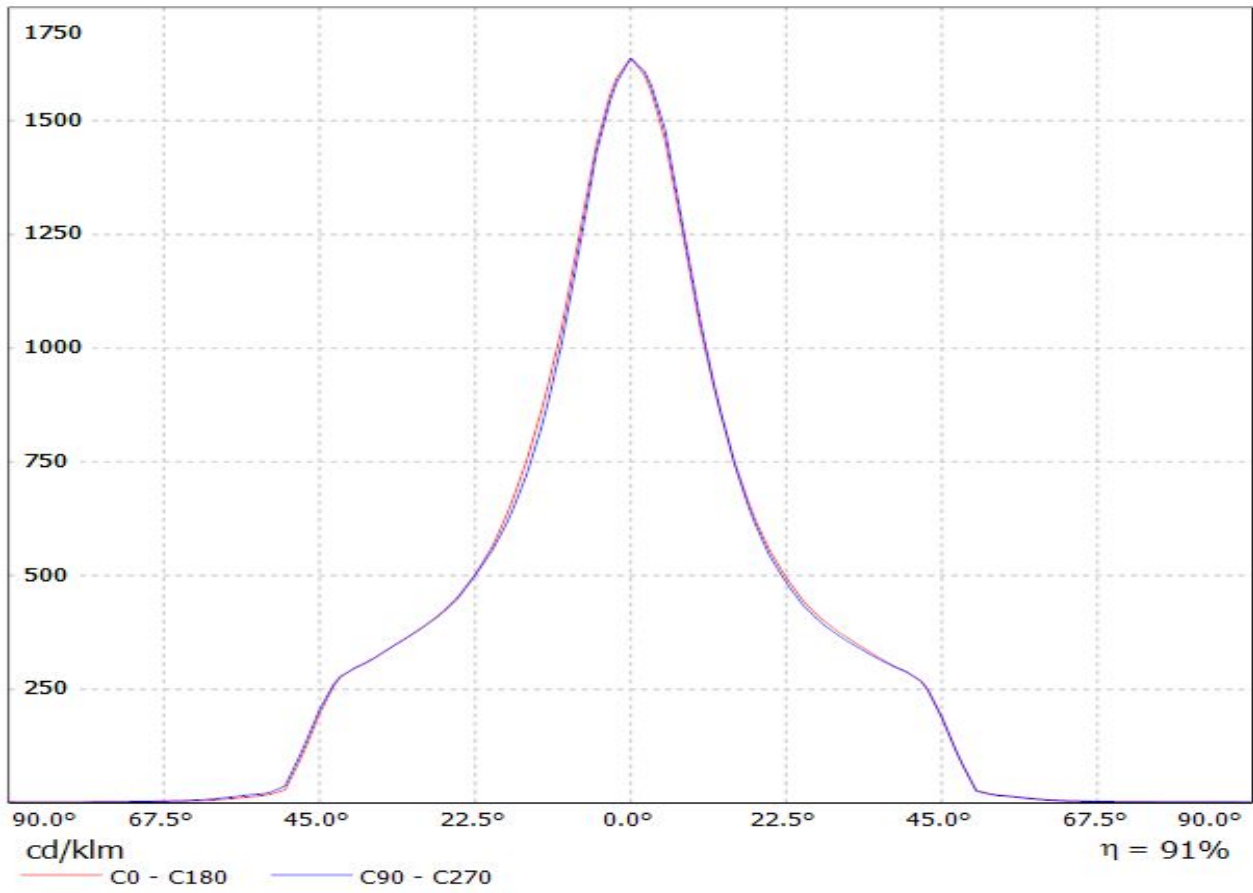

Luminaire: LEDiL Oy F13401_ANGELINA-M_(NSBxL121A)
Lamps: 1 x Nichia_NSBxL121A_914.478lm@250mA_P=7.56872W_I=249.9mA

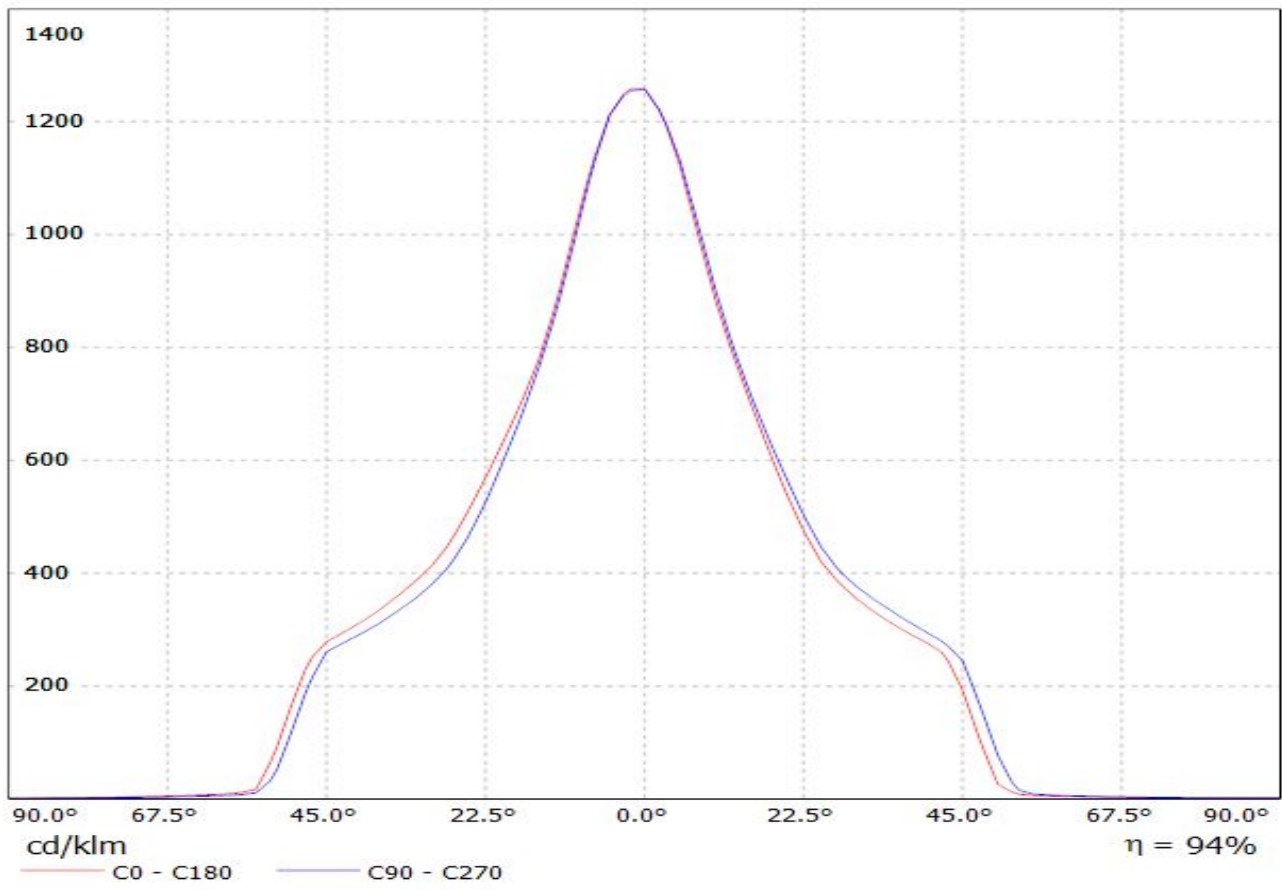

Luminaire: Ledil F13401_ANGELINA-M_(NVCLL024Z+TE)

Lamps: 1 x Nichia_NVCLL024Z_+2213382-2_+2213194-1_971.485lm@250mA_CCT=3000K_P=8W_I=0.25A

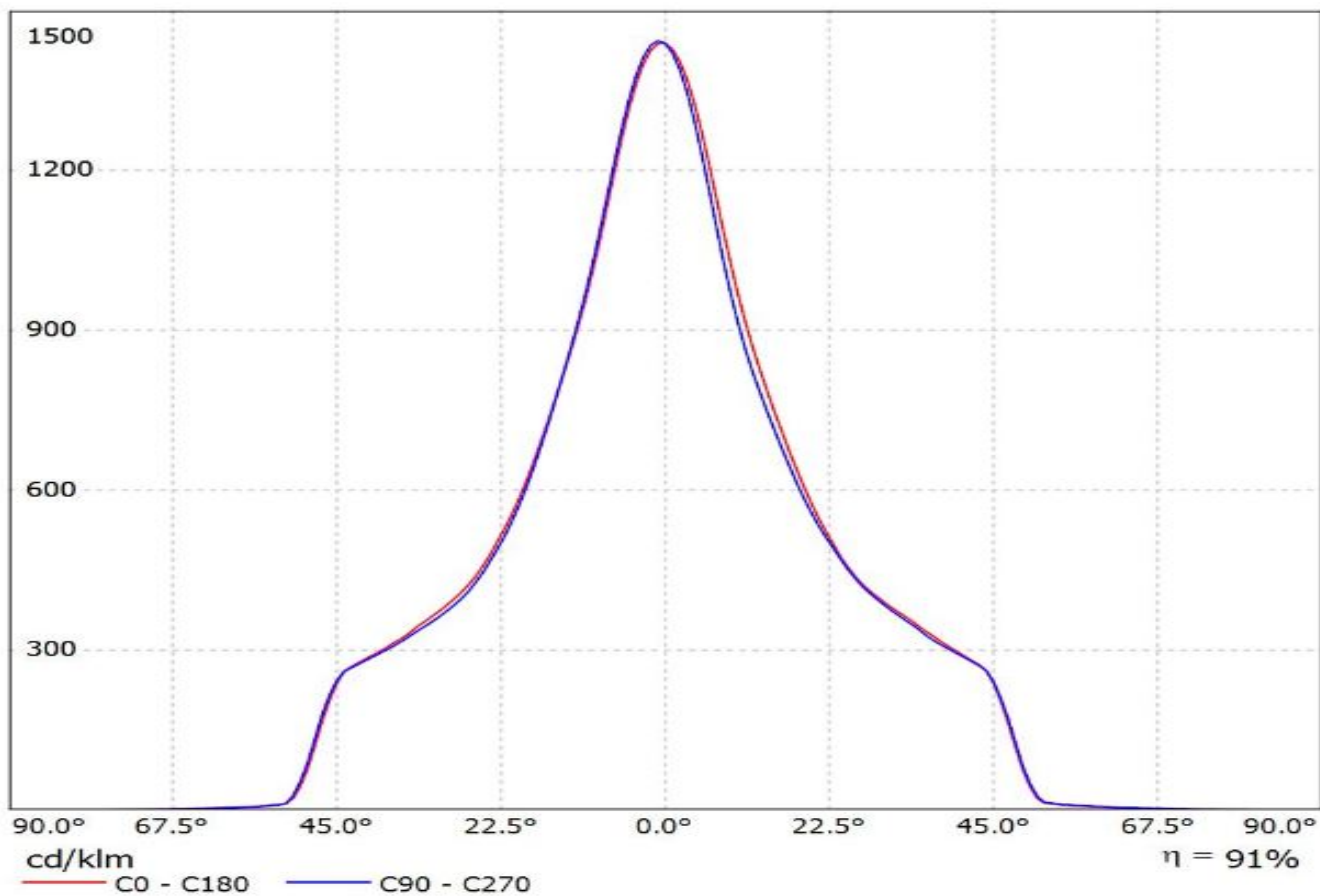

Luminaire: LEDiL Oy F13401_ANGELINA-M_(PrevaLED_LES9) Eff.93%

Lamps: 1 x OSRAM PrevaLED_LES9_(PL-CORE-1100-830-Z3)_507.9lm@100mA_P=4.5039W_I=100.1mA

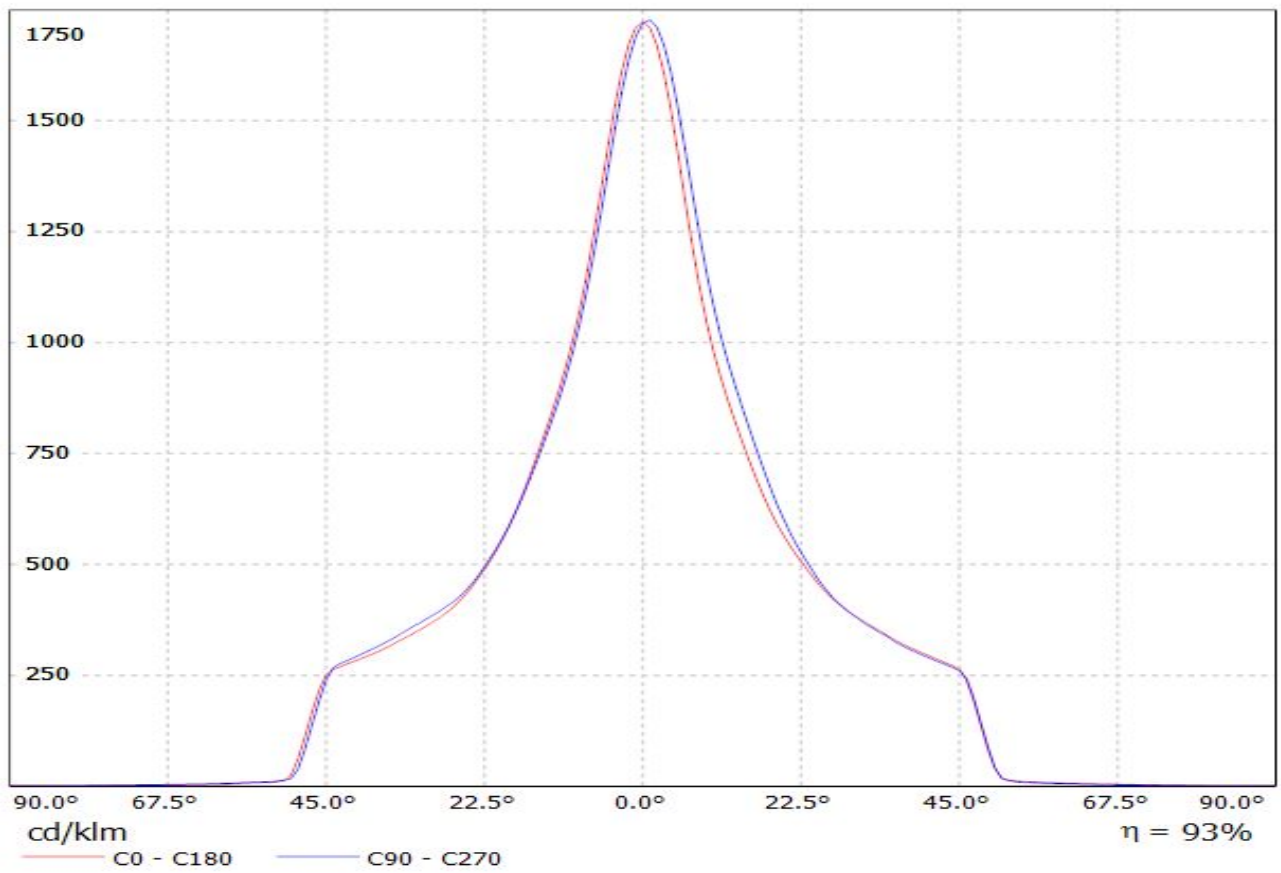

Luminaire: LEDiL Oy F13401_ANGELINA-M_(PrevaLED_LES23) Eff.94%
Lamps: 1 x OSRAM PrevaLED_LES23_(PL-CORE-5000-930-Z3)_1102.2lm@250mA_P=9.93654W_I=249.8mA

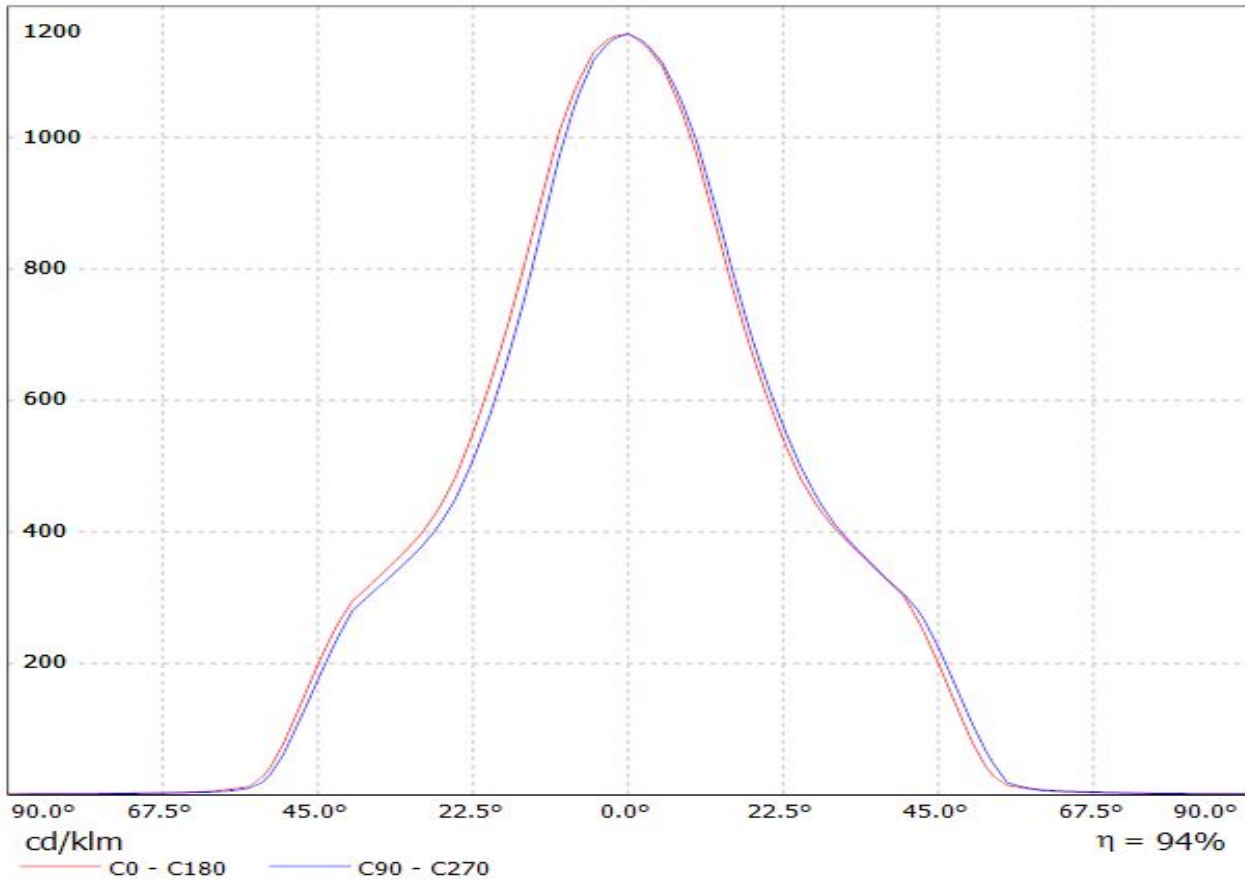

Luminaire: LEDiL Oy F13401_ANGELINA-M_(PrevaLED_LES19) Eff. 93%
Lamps: 1 x PrevaLED_LES219_(PL-CORE-2000-830-Z3)_1333.47lm@250mA_P=10.4584W_I=249.8mA

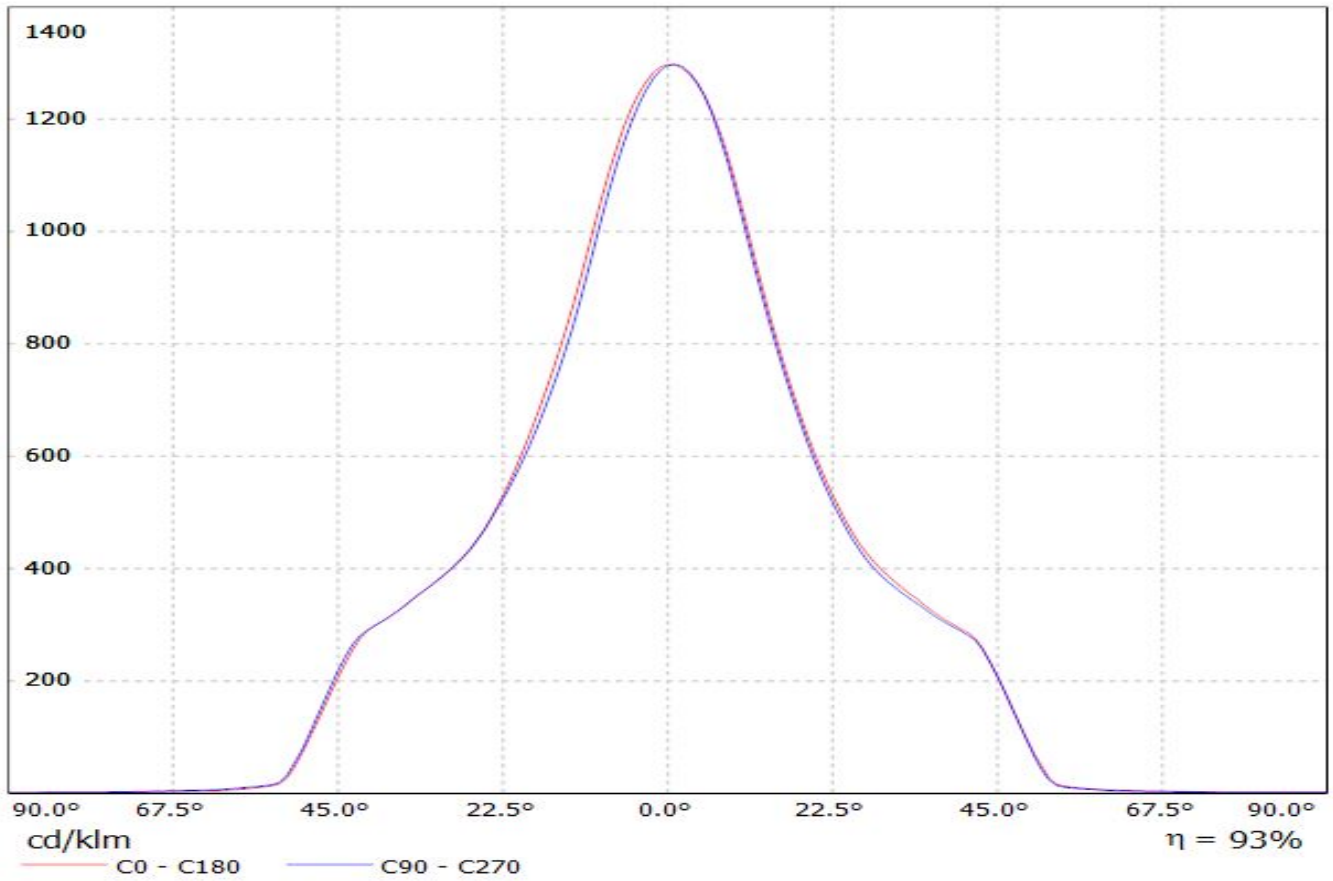

Luminaire: LEDil Oy F13401_ANGELINA-M_(Soleriq_S13) Efficiency=94%
Lamps: 1 x Osram Soleriq S13 (GW KAGHB1.EM) 855lm @ 250mA CCT=3100K P=7.5W I=250mA

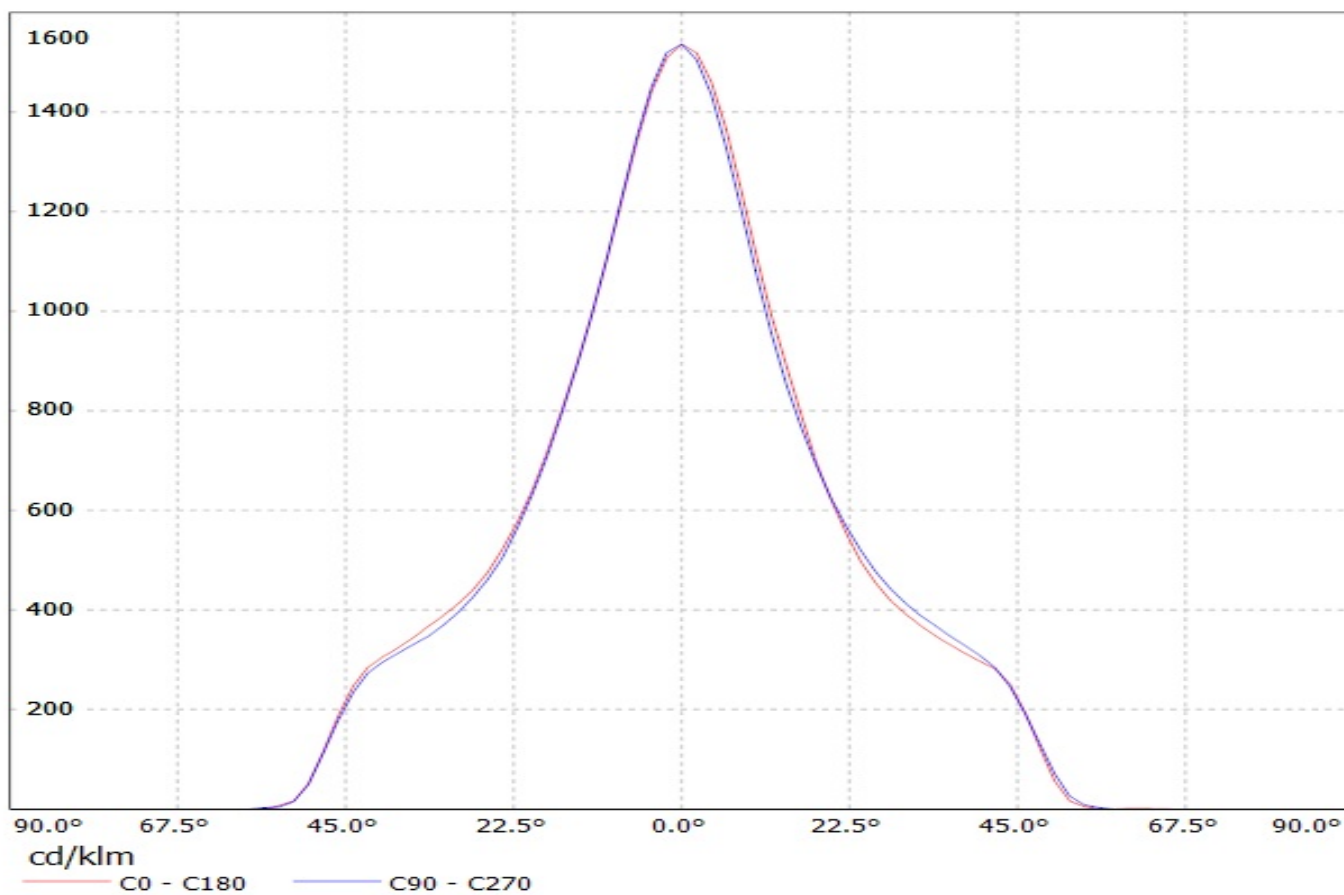

Luminaire: LEDiL Oy F13401_ANGELINA-M_(SOLERIQ_S19_&_TE_2213407-2)

Lamps: 1 x OSRAM_SOLERIQ_S19_(GW_KAHJB1.EM)_1393.62lm@250mA_CCT=3000K_P=10.5683W_I=249.8mA

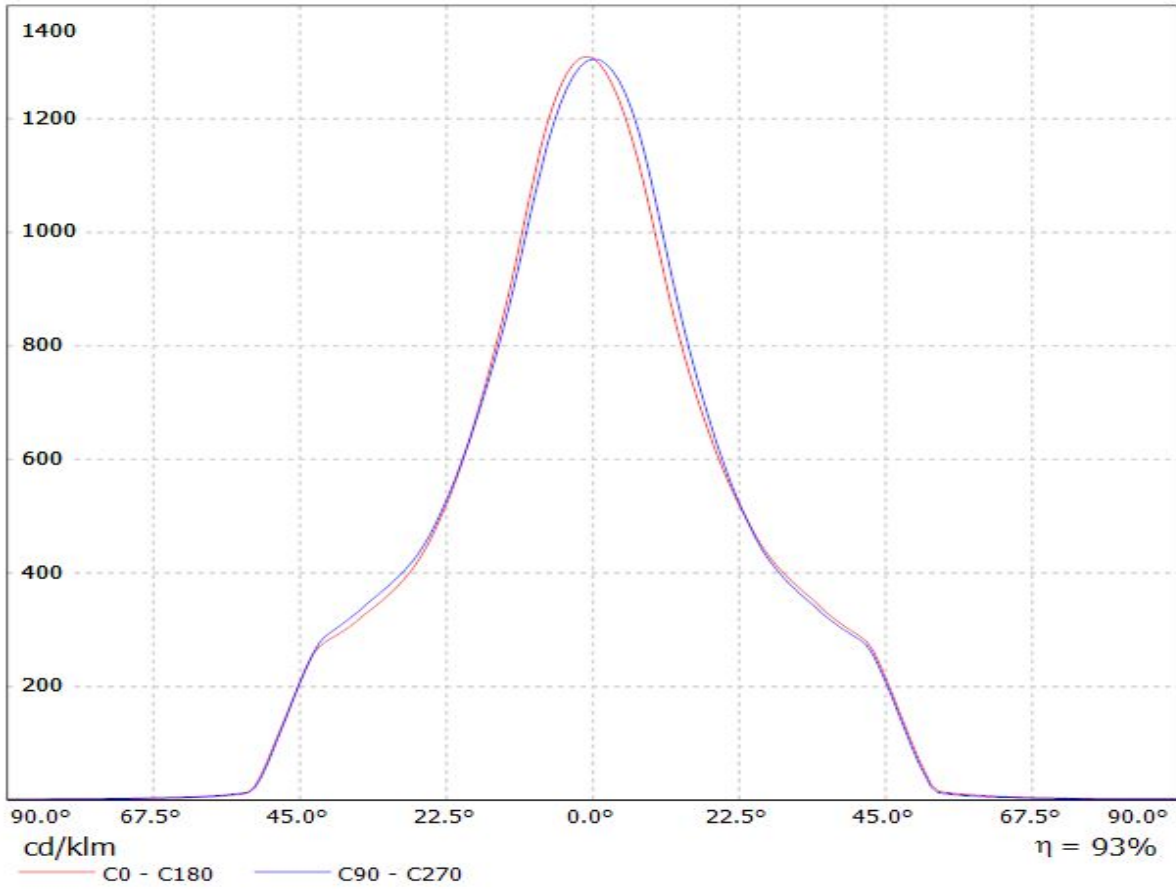

Luminaire: LEDiL Oy F13401_ANGELINA-M (LEP-800-827-C-AC)
Lamps: 1 x OSRAM PrevaLED Core AC (LEP-800-827-C-AC) 910lm@60mA U:230V P:14W

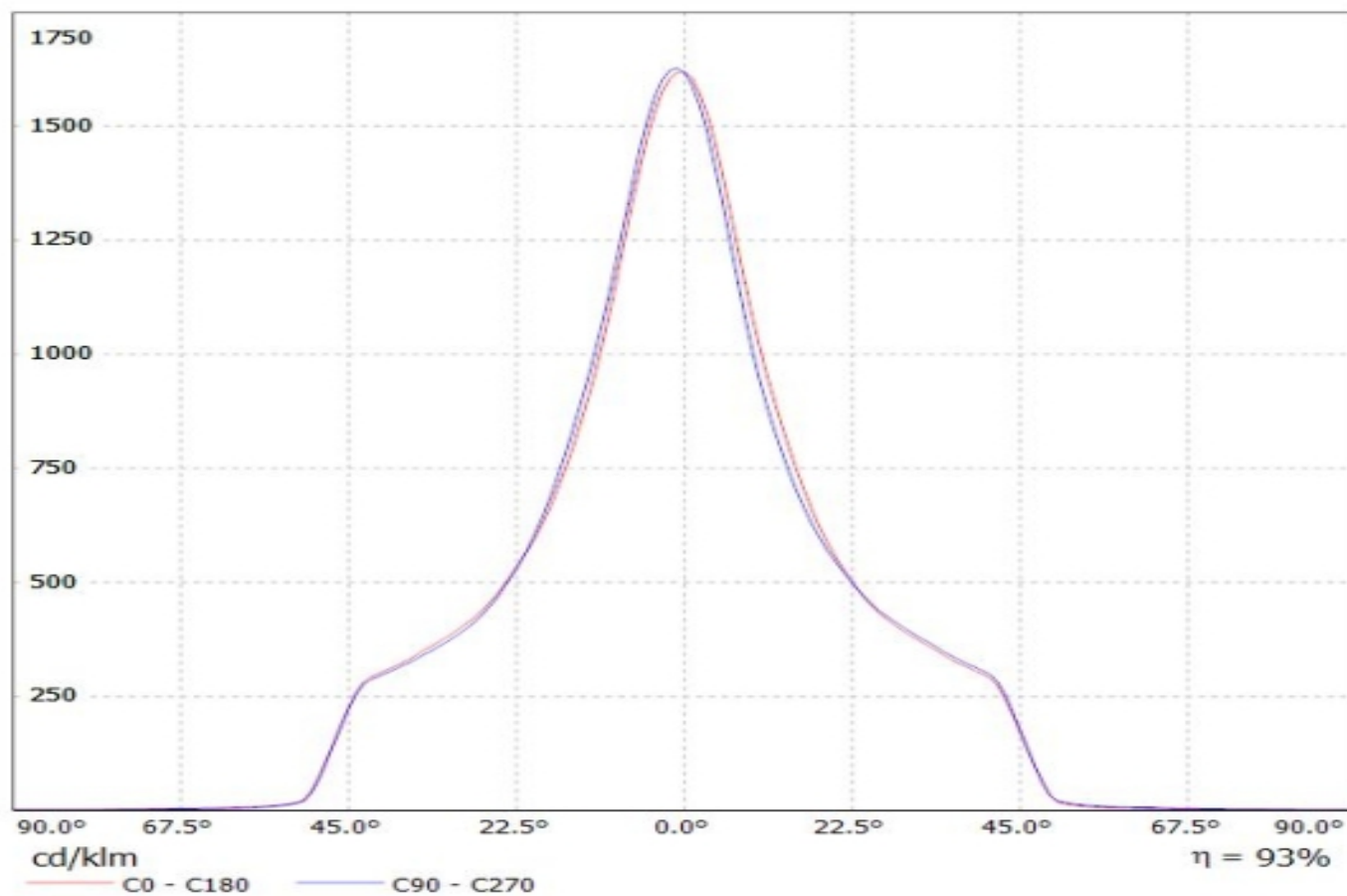

Luminaire: LEDiL Oy F13401_ANGELINA-M_(LEP-2000-827-C-AC)
Lamps: 1 x OSRAM PrevaLED Core AC (LEP-2000-827-C-AC)

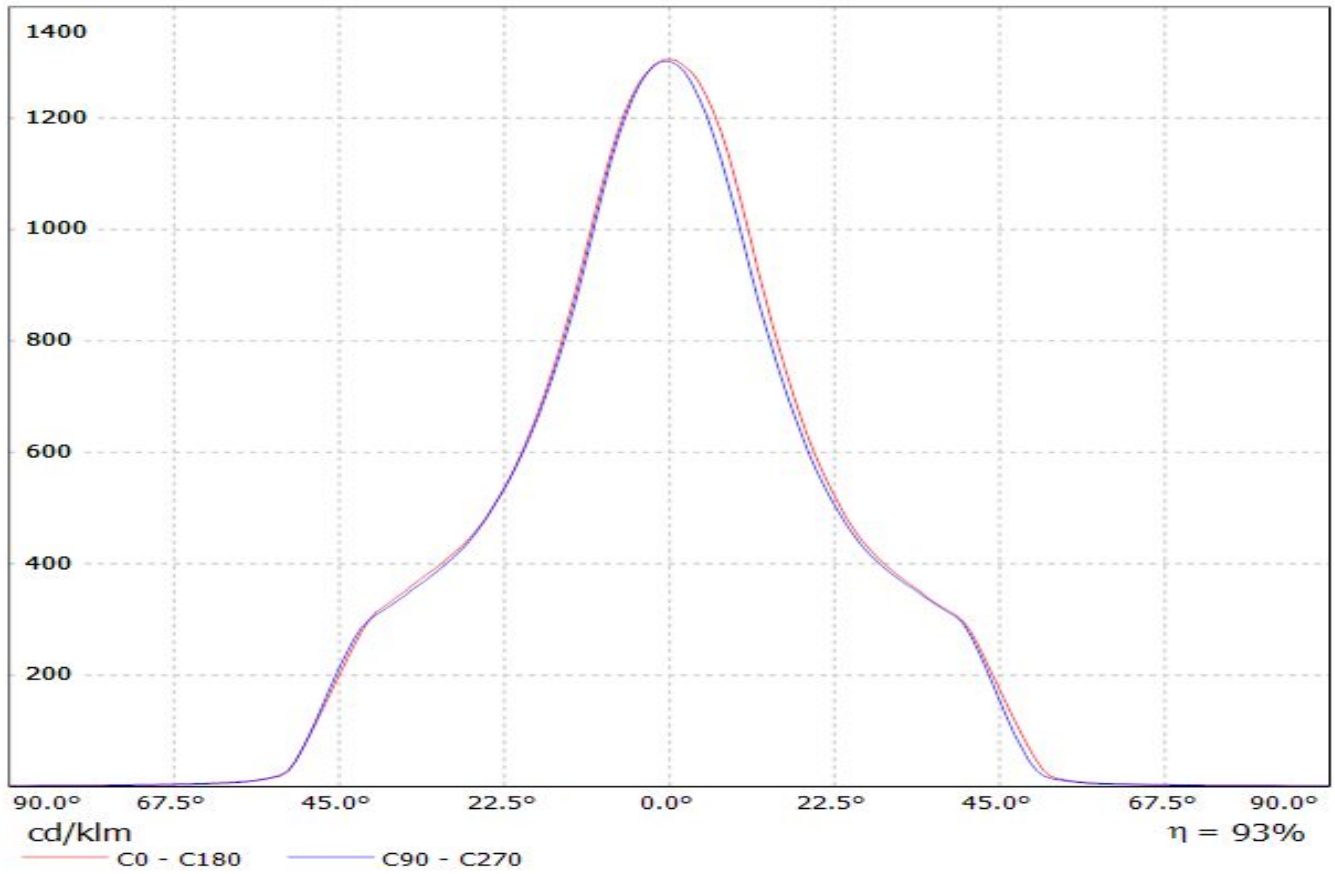

Luminaire: LEDiL Oy F13401_ANGELINA-M_(PrevaLED_Z4) Eff.93%

Lamps: 1 x Osram_PrevaLED_CORE_Z4_(PL-CORE-3000-830-Z4)_1423.93lm@250mA_P=10.7652W_I=249.9mA

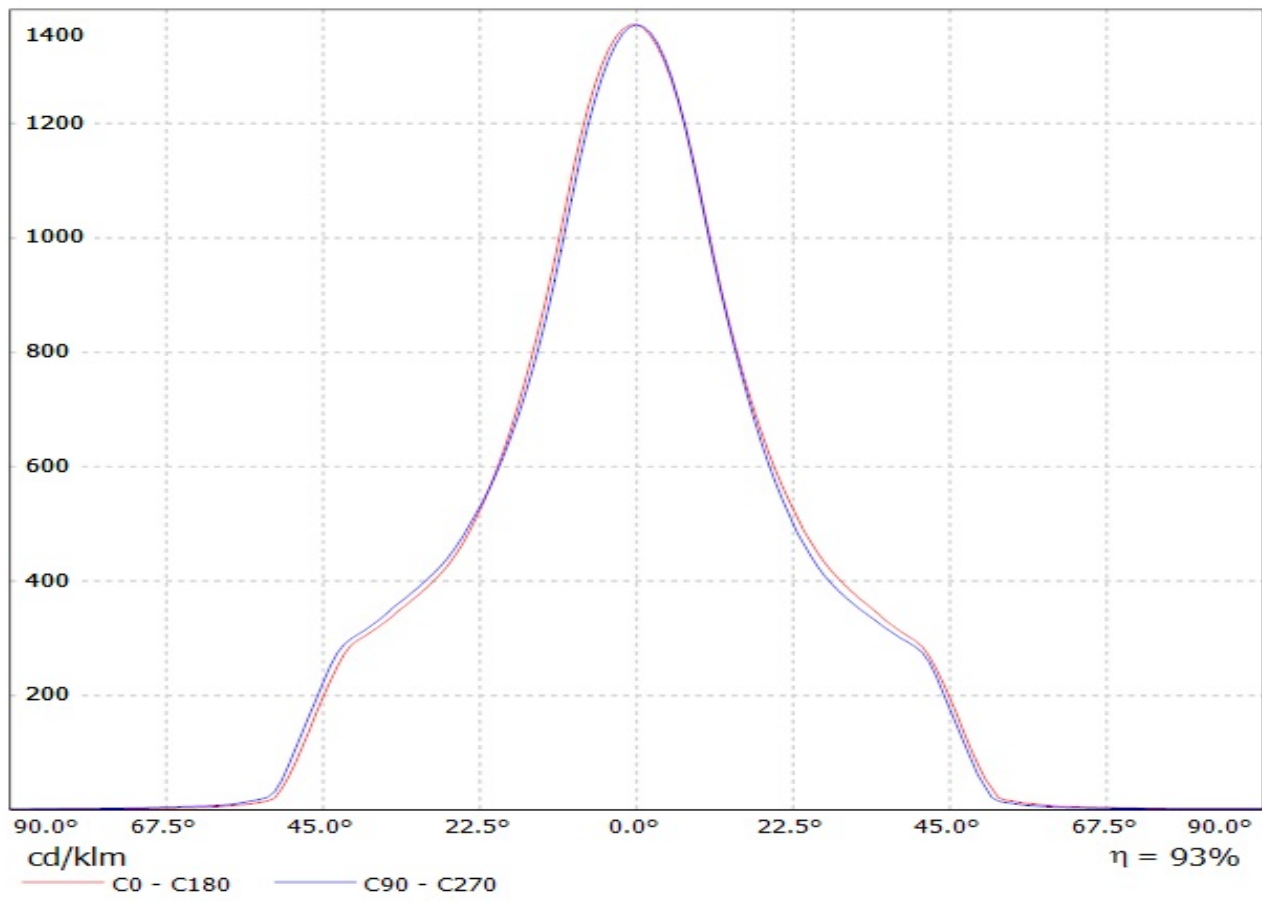

Luminaire: LEDiL Oy F13401_ANGELINA-M_(SOLERIQ_P13)

Lamps: 1 x SOLERIQ_P13_(GW_MAGMB1.EM)_1038.25lm@250mA_CCT=3000K_P=8.77223W_I=249.8mA

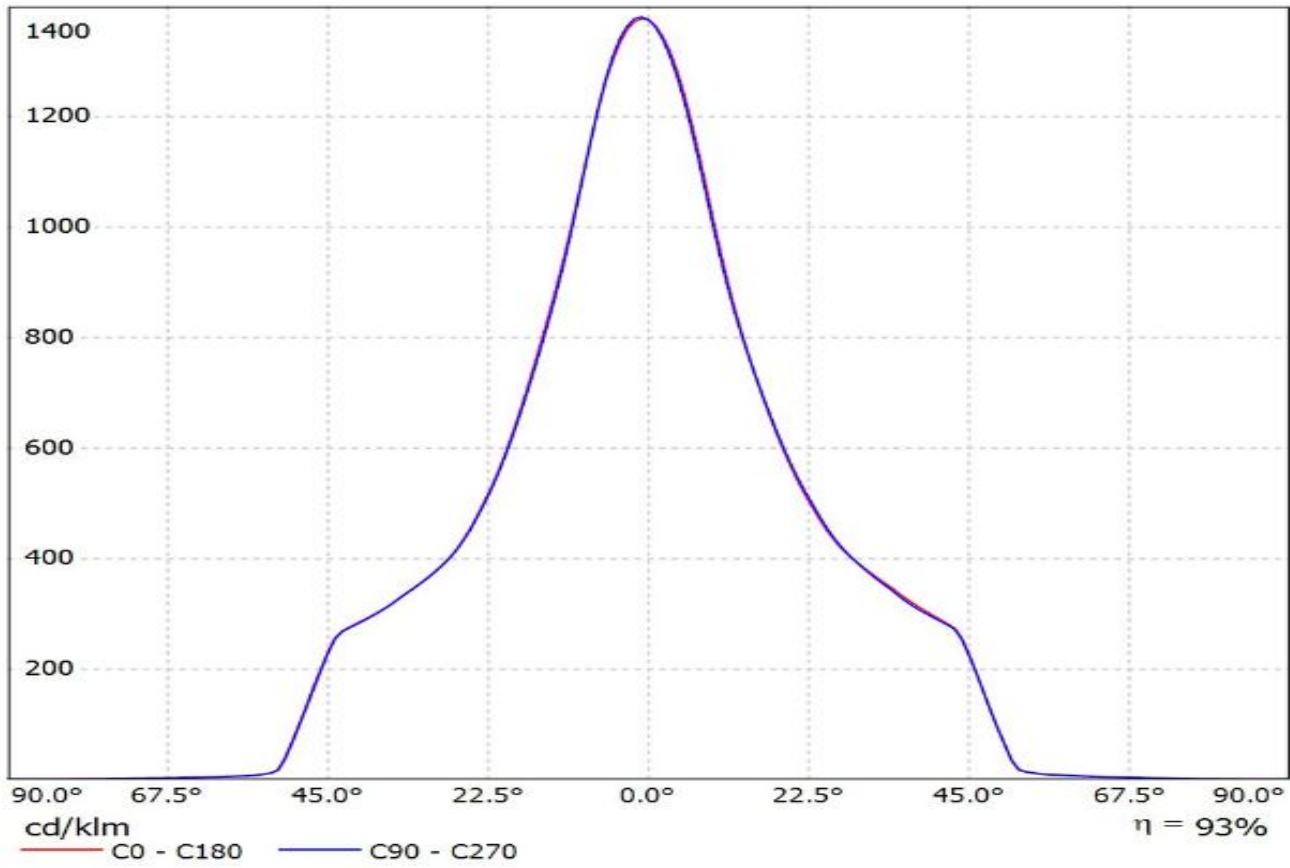

Luminaire: Ledil F13401_ANGELINA-M_(S13_Gen2+IDEAL)

Lamps: 1 x Soleriq_S13_Gen2+_50-2103CT+_50-2100AN_1327.38lm@250mA_P=8.7850W_I=0.250A

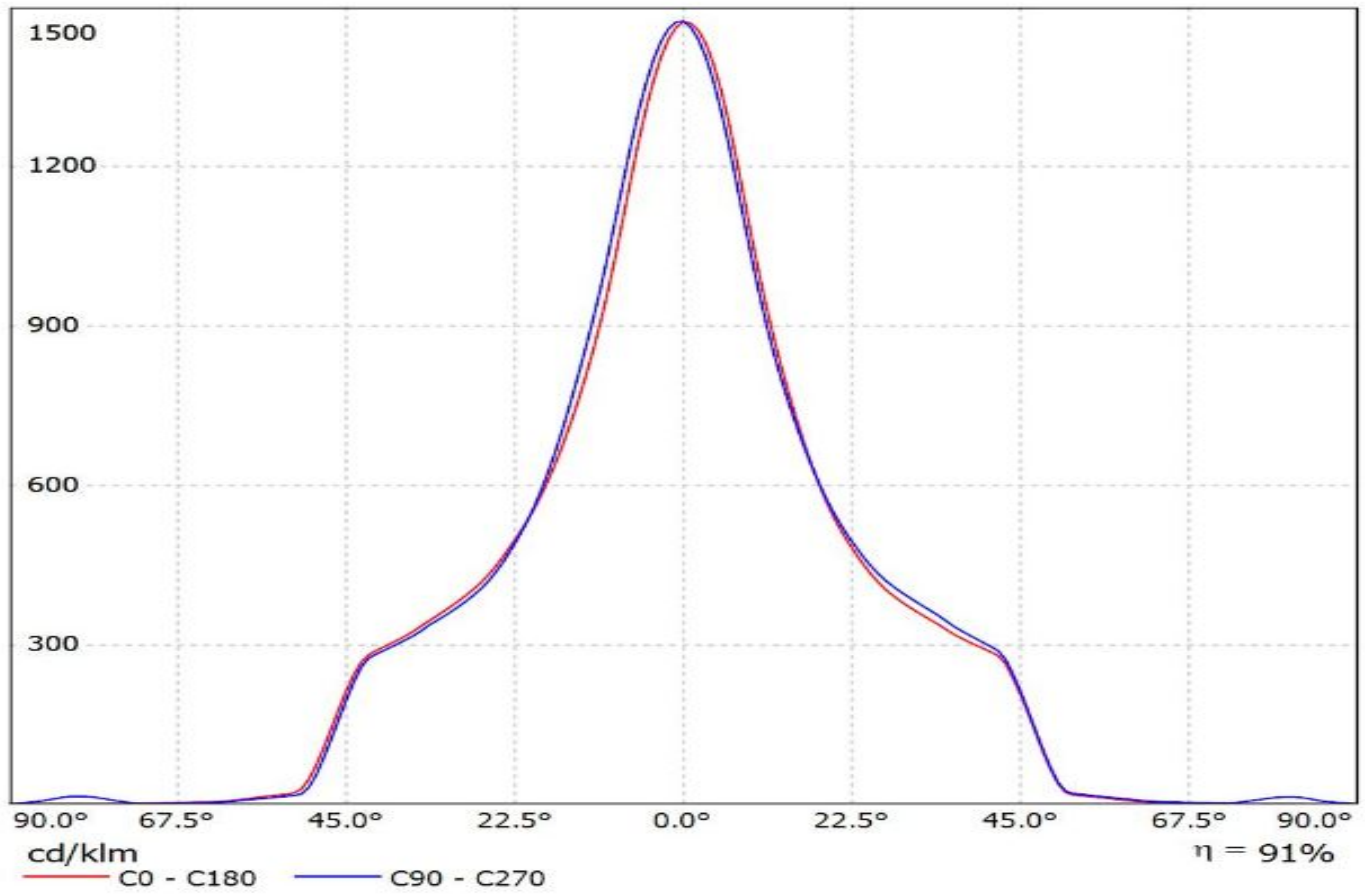

Luminaire: Ledil F13401_ANGELINA-M (S13_Gen2+TE)

Lamps: 1 x Soleriq_S13_Gen2+_2213254-2+_2213194-1_1309.23lm@250mA_P=8.7840W_I=0.250A

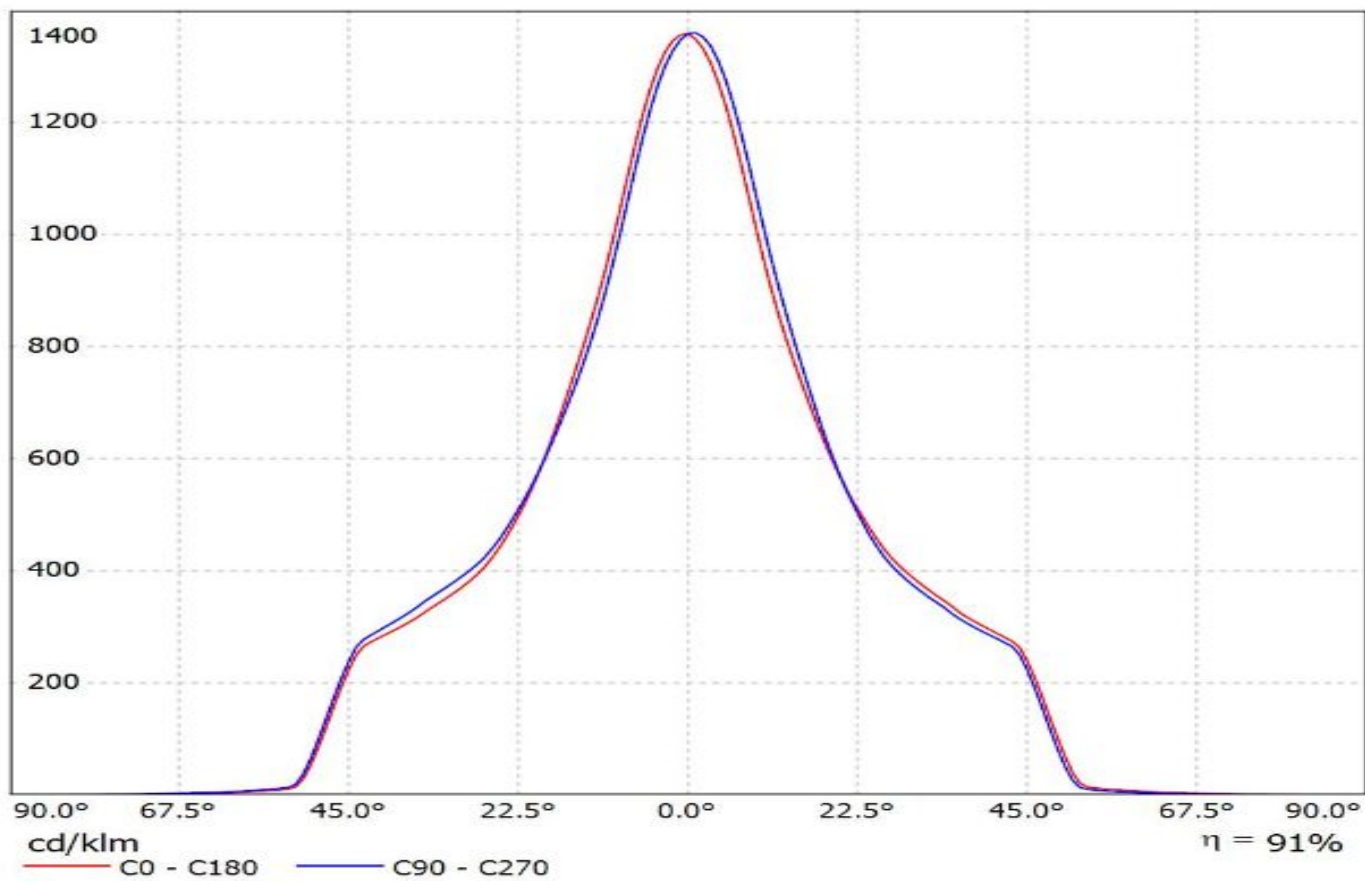

Luminaire: LEDiL Oy F13401_ANGELINA-M_(FORTIMO_2000) Eff.90.5%
Lamps: 1 x PHILIPS Fortimo LED SLM 2000 23W/930 L19 G3 665.774lm@250mA CCT=3000K P=6W I=250mA

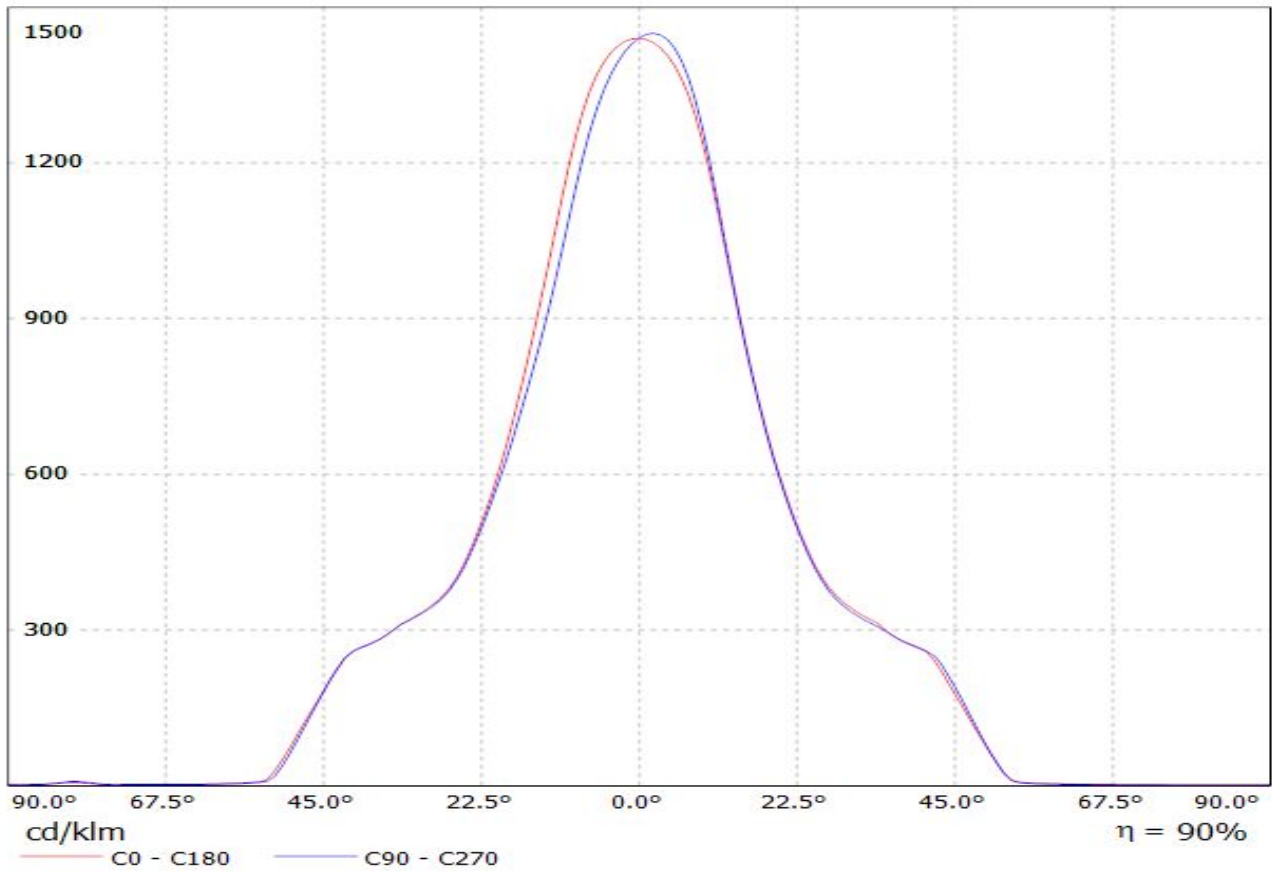

Luminaire: LEDiL Oy F13401_ANGELINA-M_(FORTIMO_3000) Eff.90.3%
Lamps: 1 x PHILIPS Fortimo LED SLM 3000 28W/830 L19 G3 1046.76lm@250mA CCT=3000K P=9W I=250mA

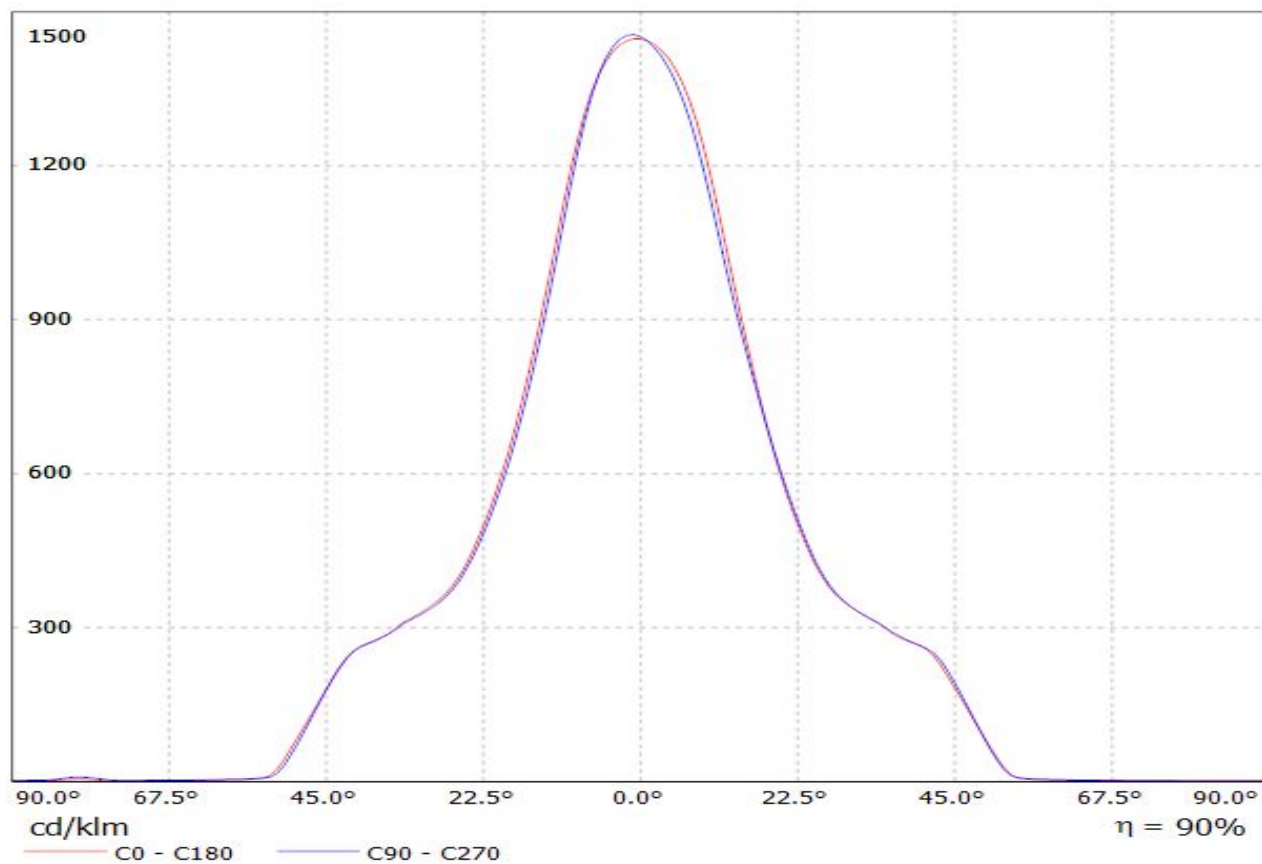

Luminaire: LEDiL Oy F13401_ANGELINA-M_(FORTIMO_3000) Eff.90.3%
Lamps: 1 x PHILIPS Fortimo LED SLM 3000 28W/830 L19 G3 1046.76lm@250mA CCT=3000K P=9W I=250mA

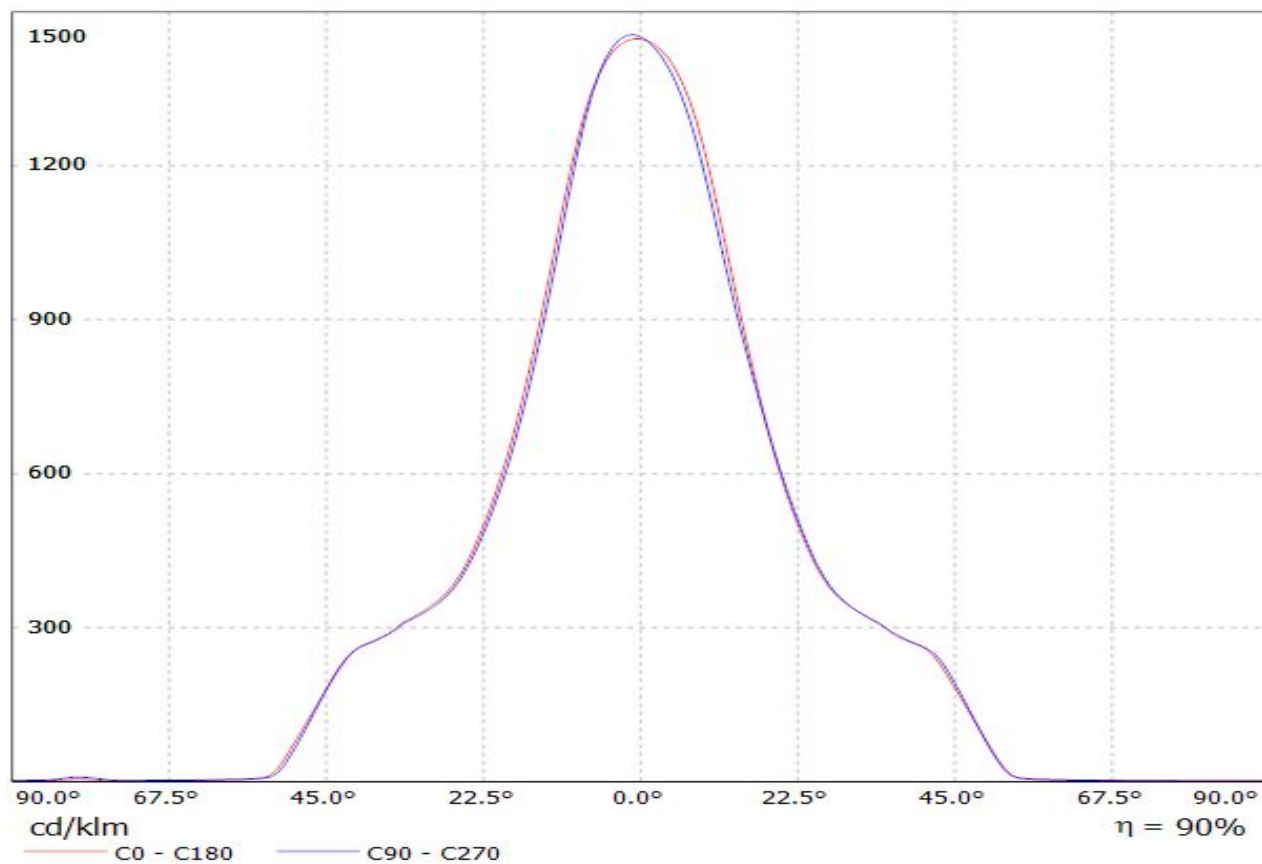

Luminaire: LEDiL Oy F13401_ANGELINA-M_(Fortimo LED SLM 1100 lm 830 L9 G4)
Lamps: 1 x Fortimo LED SLM 1100 lm 830 L9 G4_1021.27lm@250mA_P=9.2431W_I=0.2498A

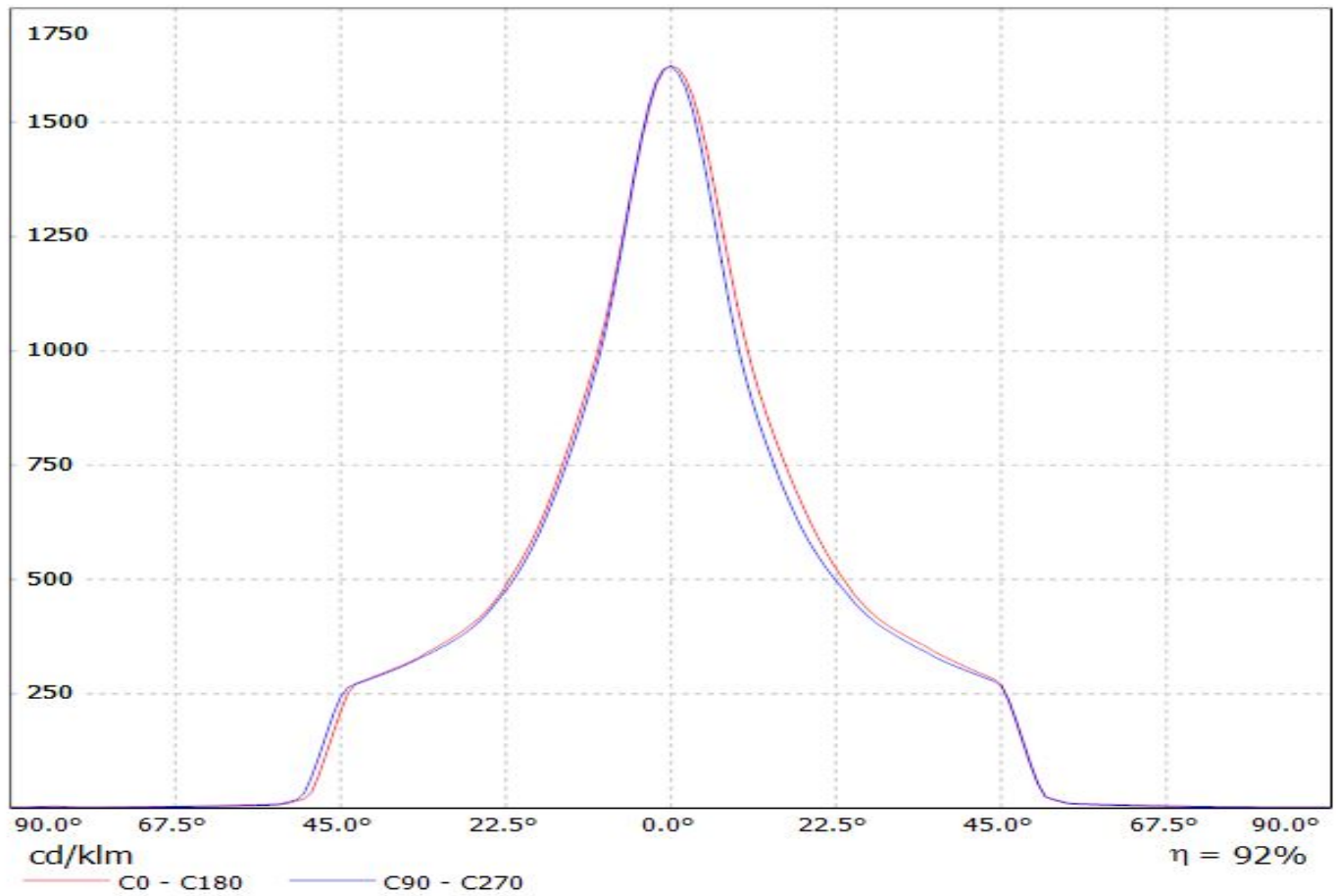

Luminaire: LEDiL Oy F13401_ANGELINA-M_(Fortimo LED SLM L13 G4)
Lamps: 1 x Fortimo LED SLM L13 G4_1106.74lm@250mA_P=8.38104W_I=0.2498A

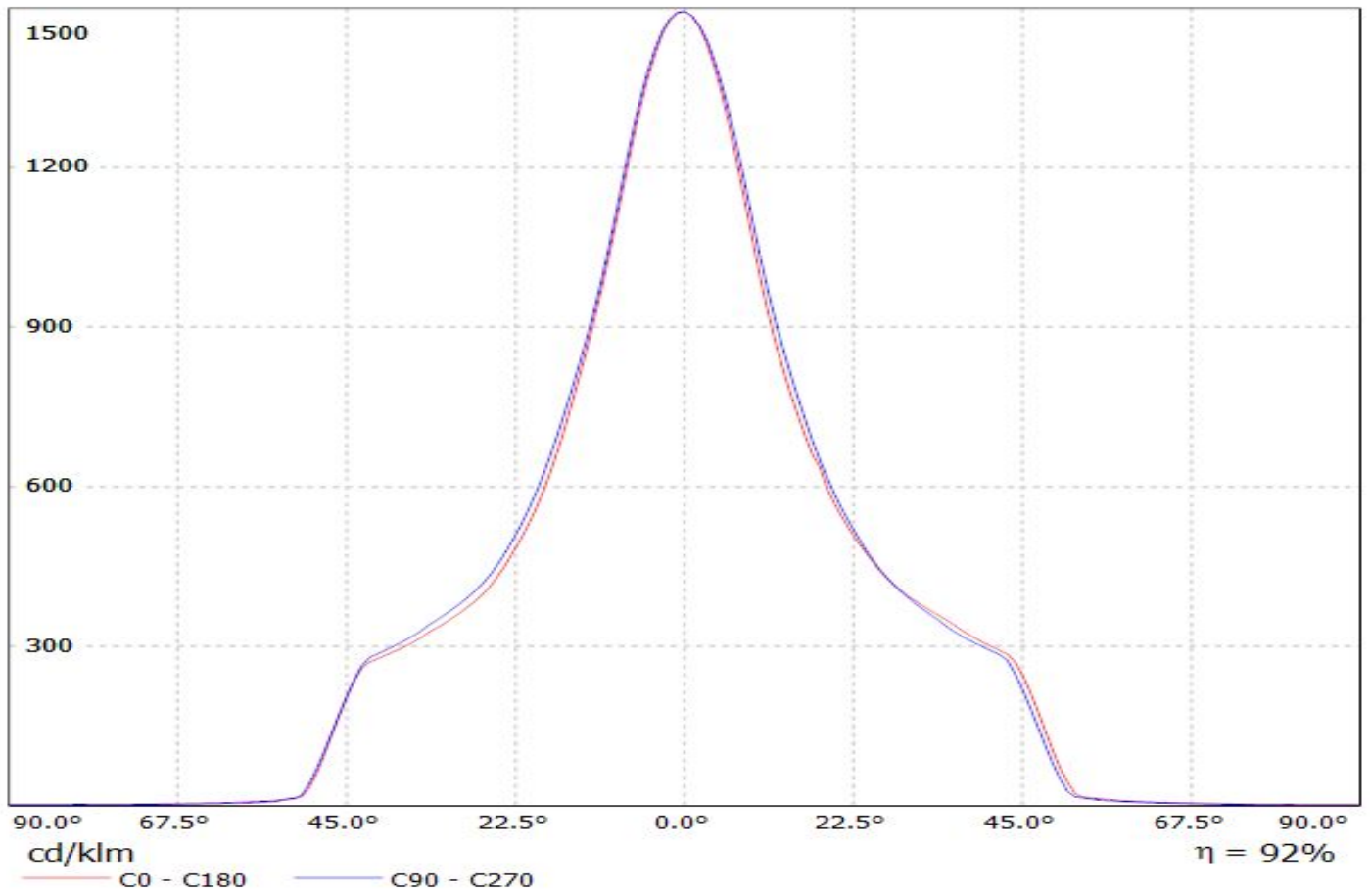

Luminaire: LEDiL Oy F13401_ANGELINA-M_(Fortimo LED SLM L15 G4)
Lamps: 1 x Fortimo LED SLM L15 G4_1116.47lm@250mA_P=8.21168W_I=0.2498A

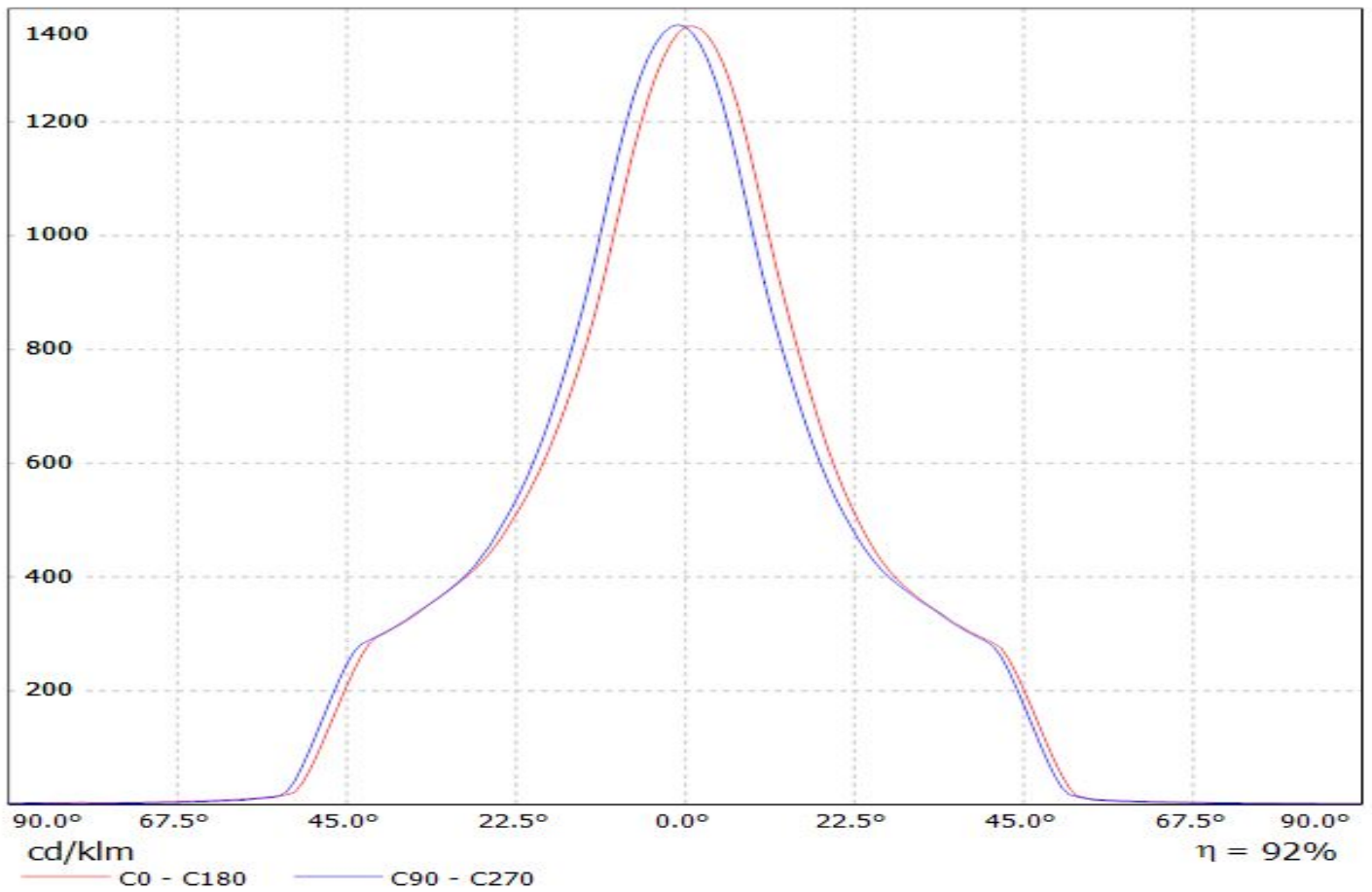

Luminaire: LEDiL Oy F13401_ANGELINA-M_(Fortimo LED SLM L19 G4)
Lamps: 1 x Fortimo LED SLM L19 G4_1114.89lm@250mA_P=8.04906W_I=0.2498A

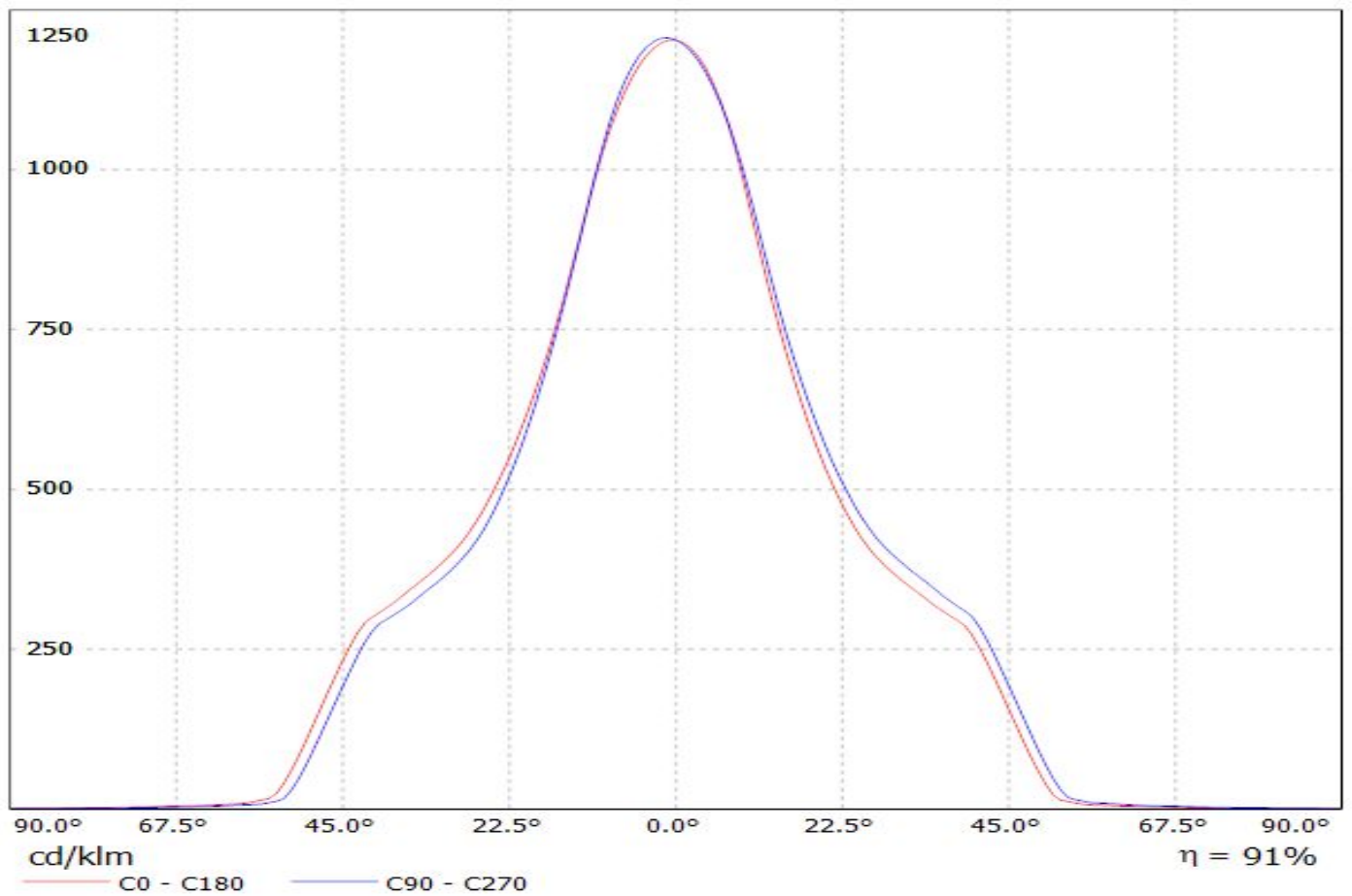

Luminaire: LEDiL Oy F13401_ANGELINA-M_(SLM-G5-LES-9)_(Z50-Optic-Clip)
Lamps: 1 x Fortimo_SLM-G5-LES-9_1182.49lm@250mA_P=8.5848W_I=0.250A

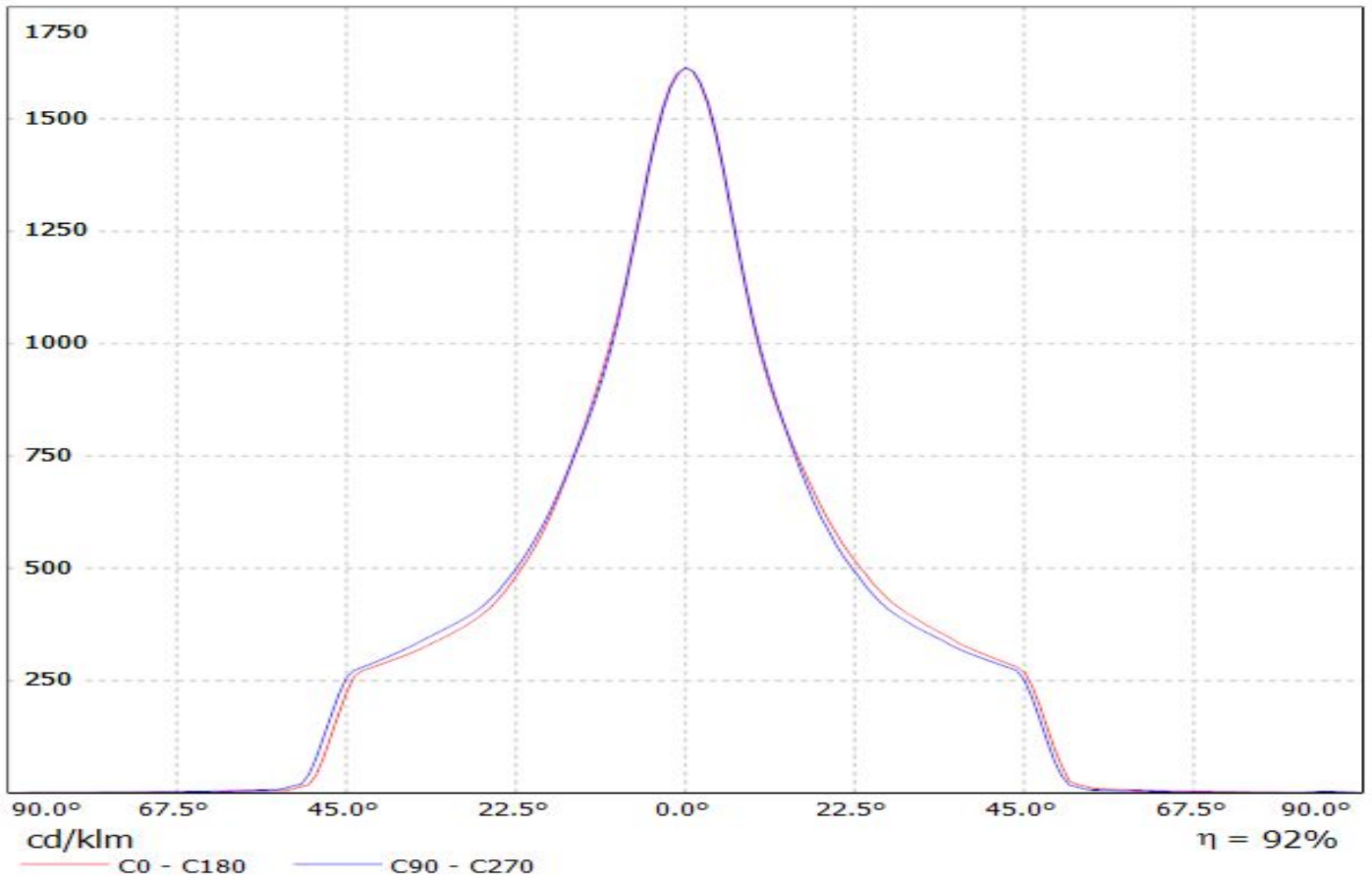

Luminaire: LEDiL Oy F13401_ANGELINA-M_(SLM-G5-LES-9)_(Z50-Optic-Clip)
Lamps: 1 x Fortimo_SLM-G5-LES-9_1182.49lm@250mA_P=8.5848W_I=0.250A

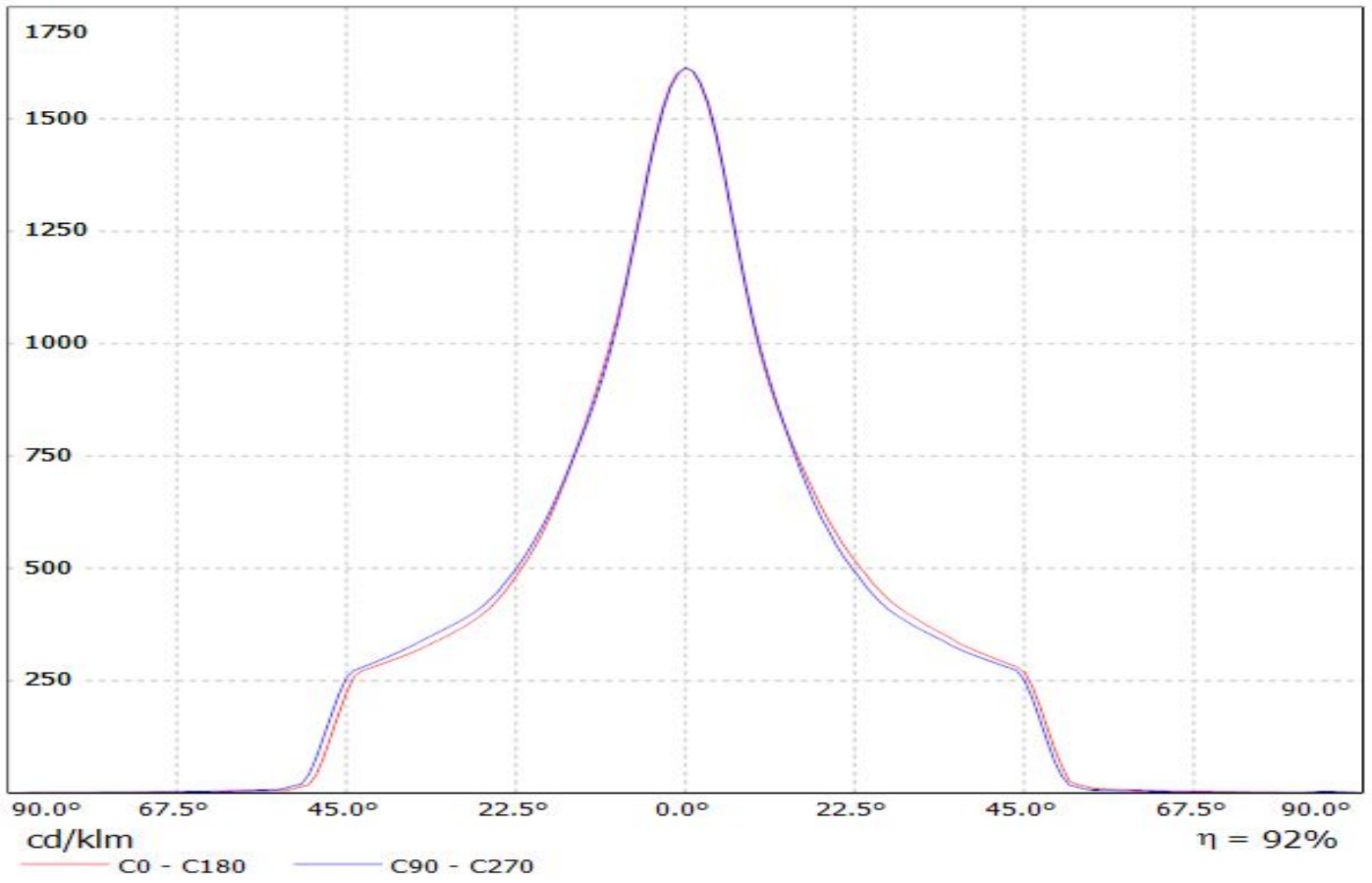

Luminaire: LEDiL Oy F13401_ANGELINA-M_(SLM-G5_LES-15)
Lamps: 1 x Fortimo_SLM-G5_LES-15_1257.61lm@250mA_P=8.1569W_I=0.250A

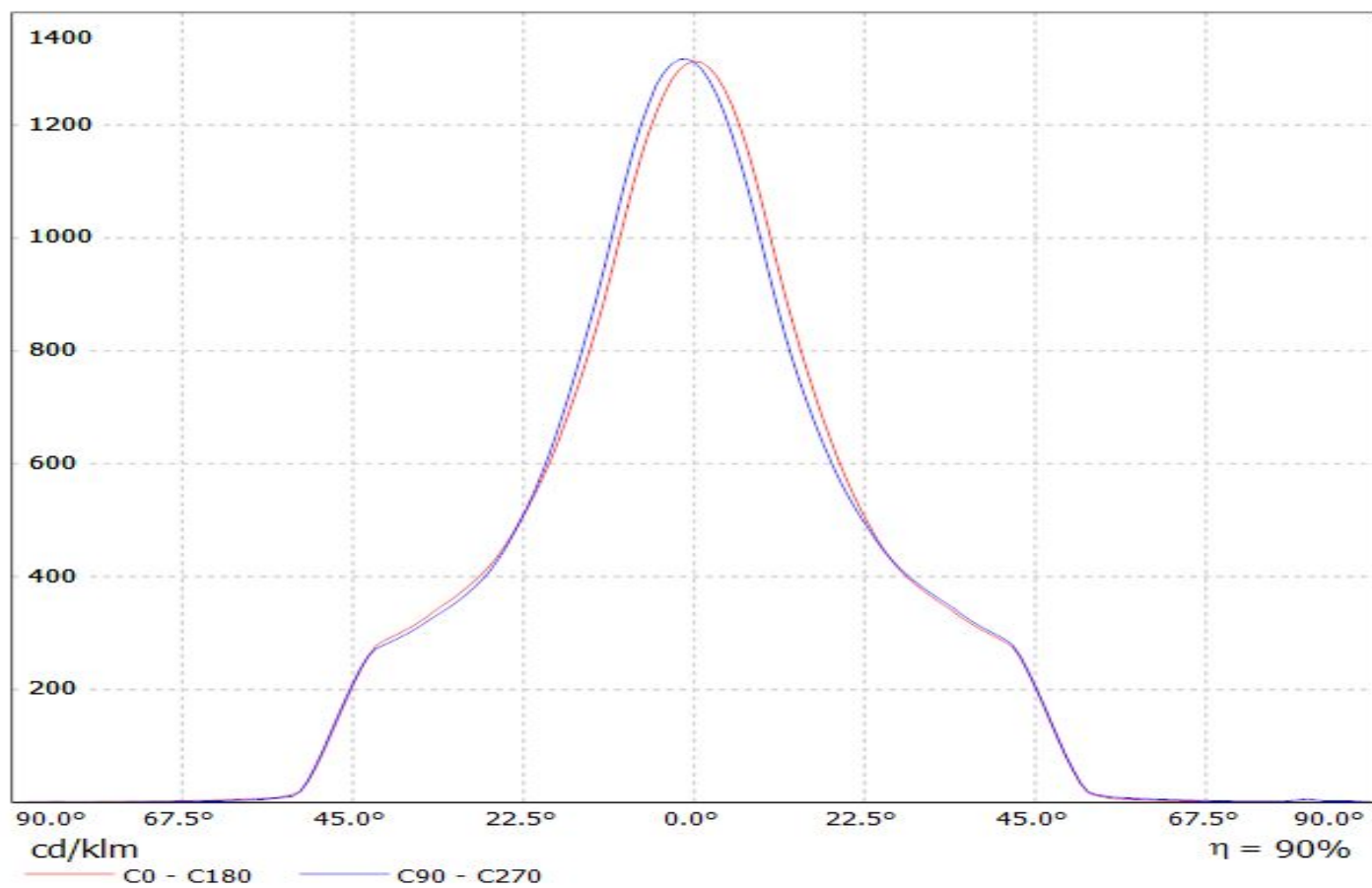

Luminaire: LEDiL Oy F13401_ANGELINA-M_(SLM-G5_LES-19)_(Z50_Optic_Clip)
Lamps: 1 x Fortimo_SLM-G5_LES-19_1397.58lm@250mA_P=8.0385W_I=0.250A

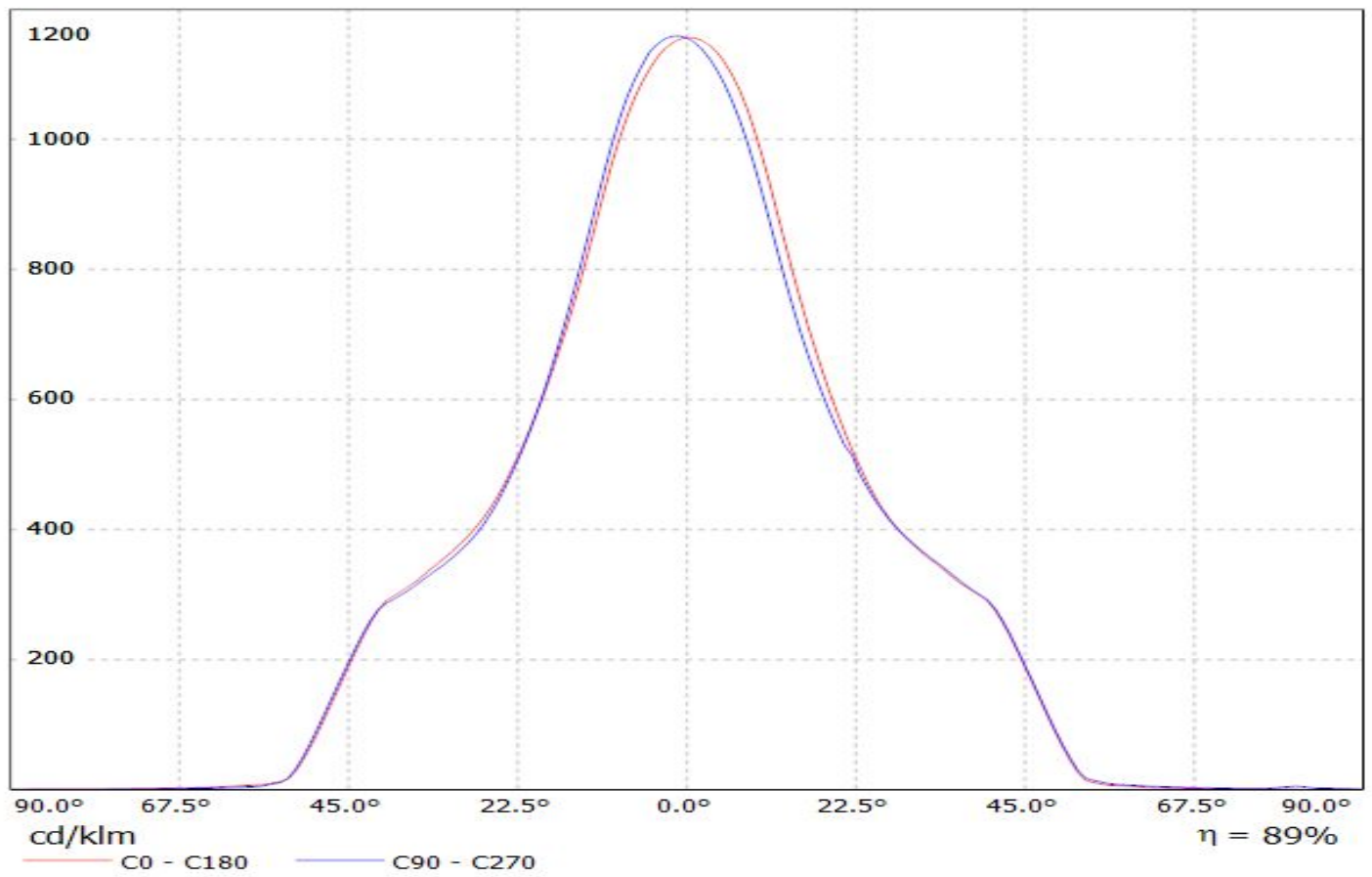

Luminaire: LEDiL Oy F13401_ANGELINA-M_(SLM-G5_LES-13)_(Z50-Optic-Clip)
Lamps: 1 x Fortimo_SLM-G5_LES-13_1300.47lm@250mA_P=8.4010W_I=0.250A

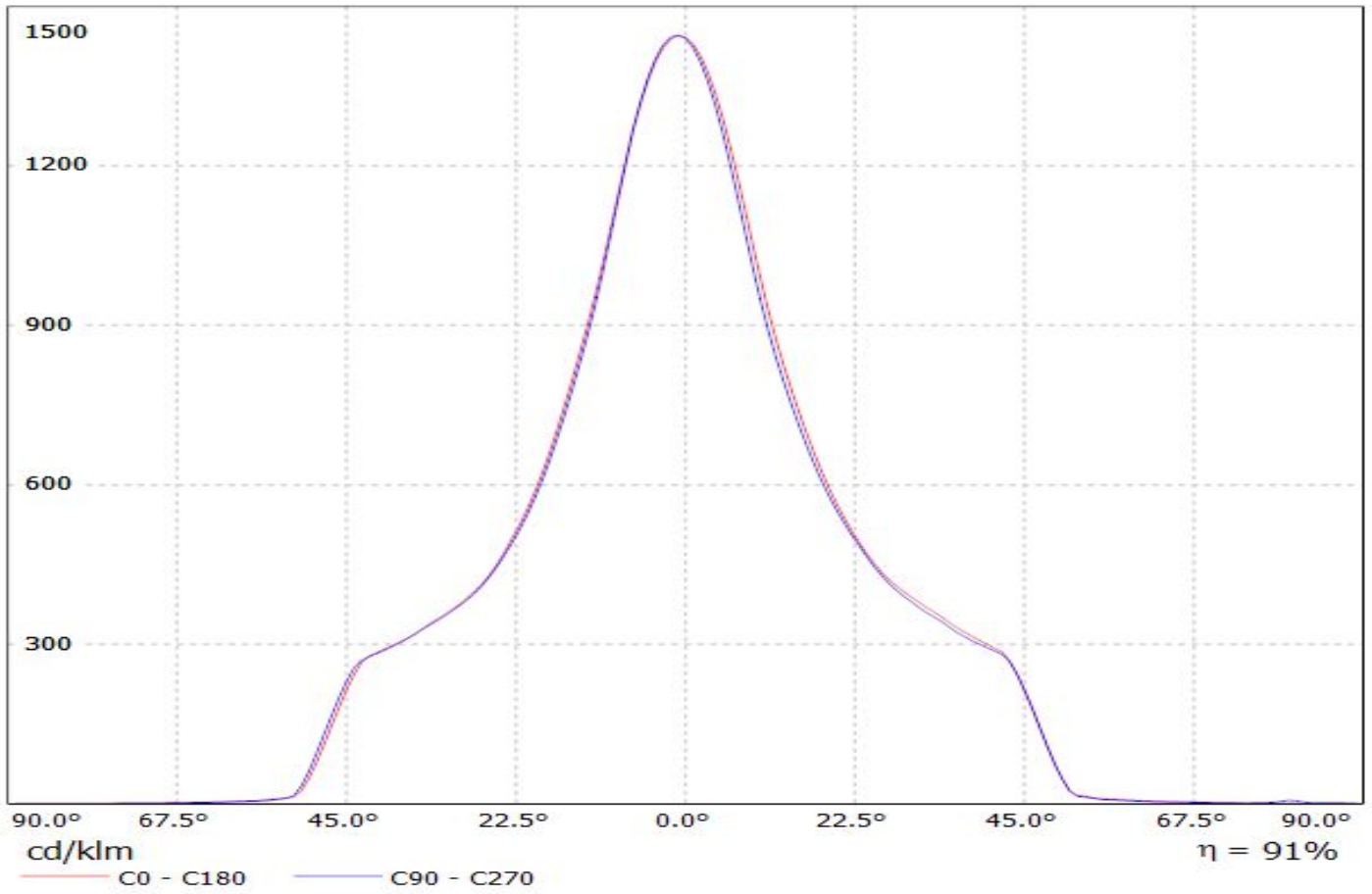

Luminaire: Ledil F13401_ANGELINA-M (SLM_1211_L19_G6_+TE)

Lamps: 1 x Philips_Fortimo_SLM_1211_L19_G6_Standard_+_TE_OPTIC_CLIP_Z50_TYPE1:_2213194-1_1146.84lm@250mA_P=8.13175W_η=0.25A

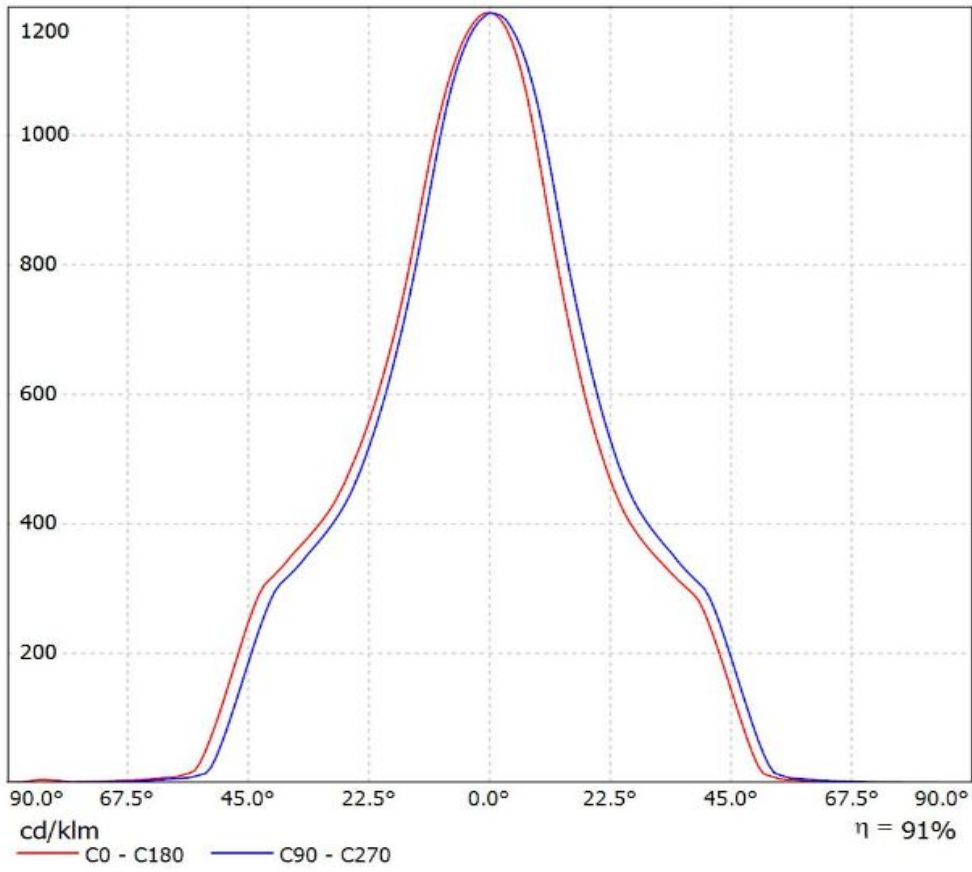

Luminaire: LEDiL Oy F13325_ANGELINA-S_(COB-LC026B) Eff.93.5%

Lamps: 1 x SAMSUNG_COB-LC026B_(SPHWWTHDNC25YHV52F)_1136.23lm@250mA_P=8.23191W_I=249.8mA

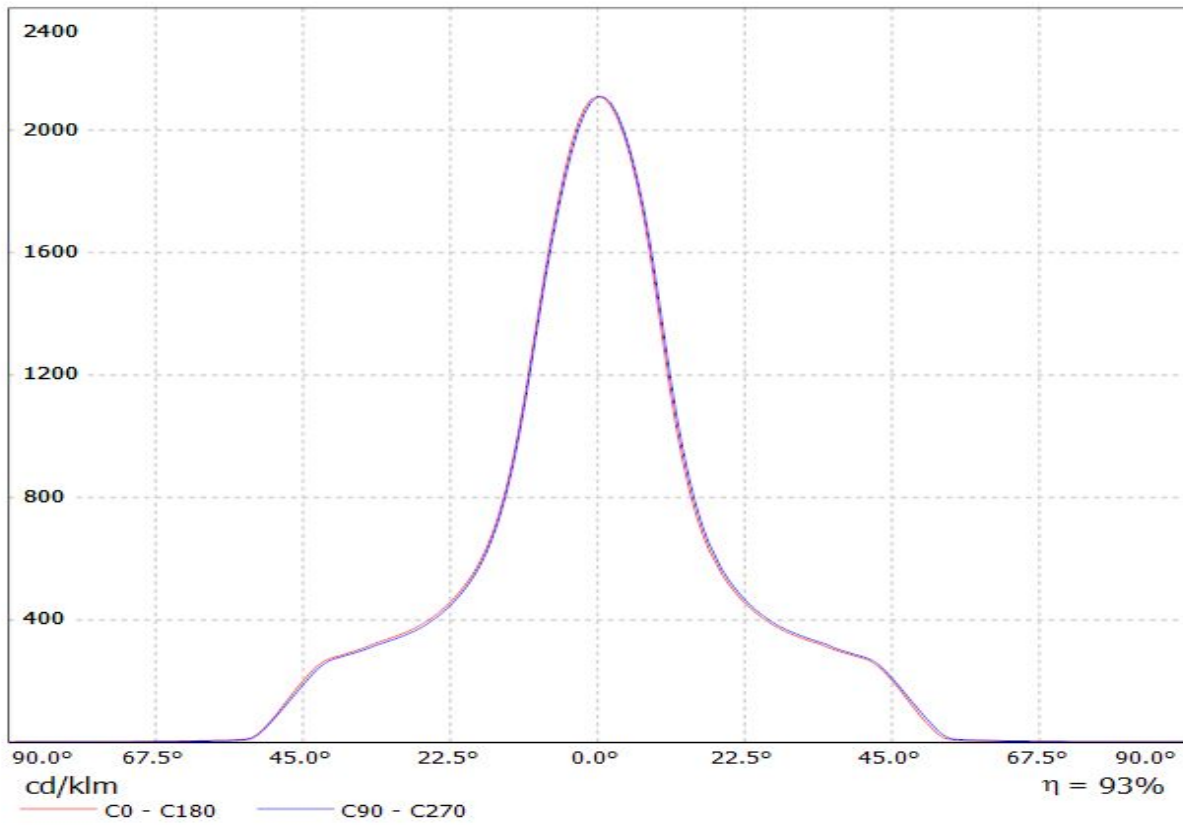

Luminaire: Ledil F13401_ANGELINA-M (LC040C+TE)

Lamps: 1 x Samsung_LC040C+_2213382-2+_2213194-1_1194.16lm@250mA_CCT=4000K_P=8.137W

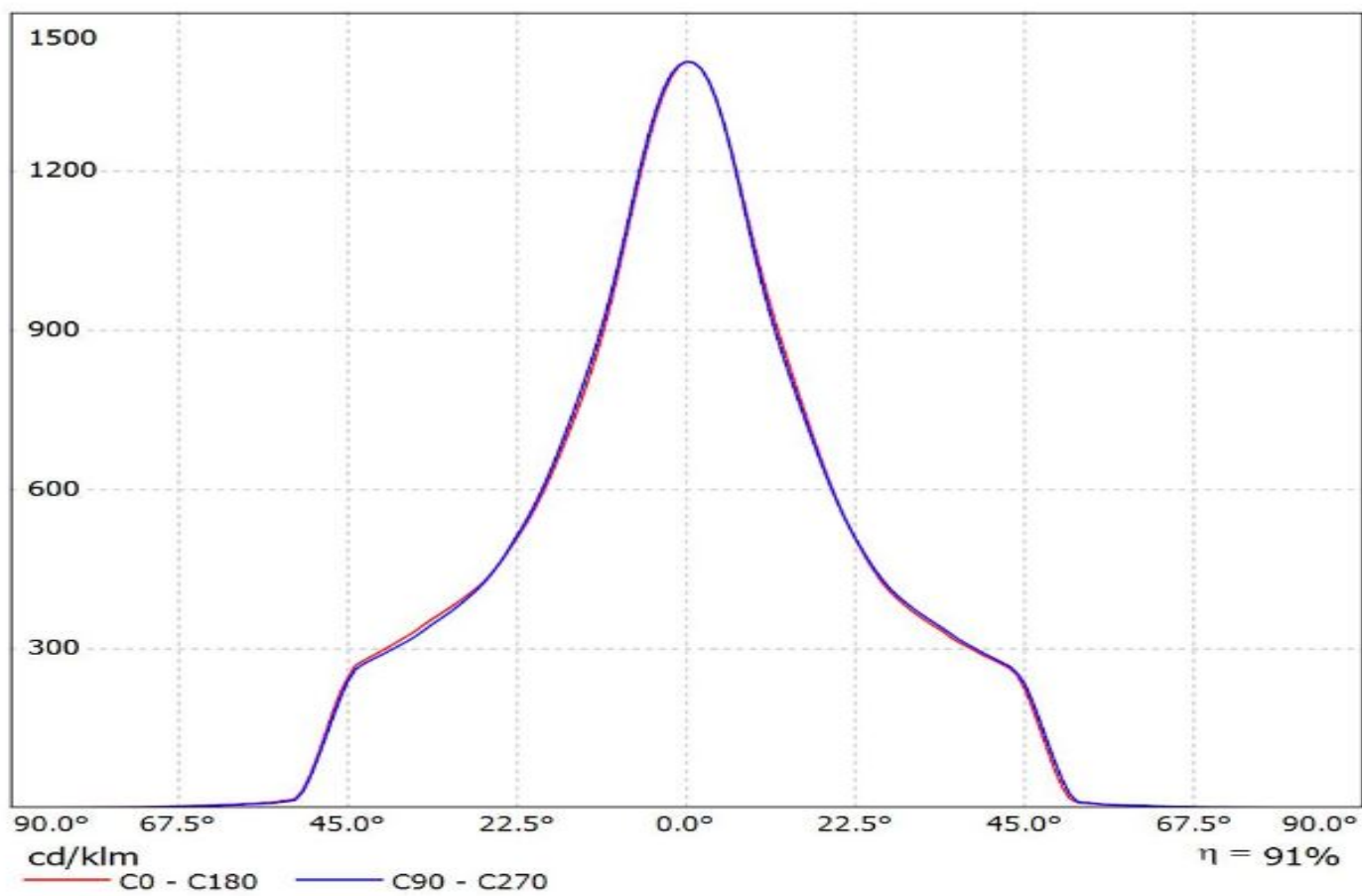

Luminaire: LEDiL Oy F13401_ANGELINA-M_(MegaZenigata) 92.0%
Lamps: 1 x MegaZenigata_GW6DME (518.495lm@100mA)

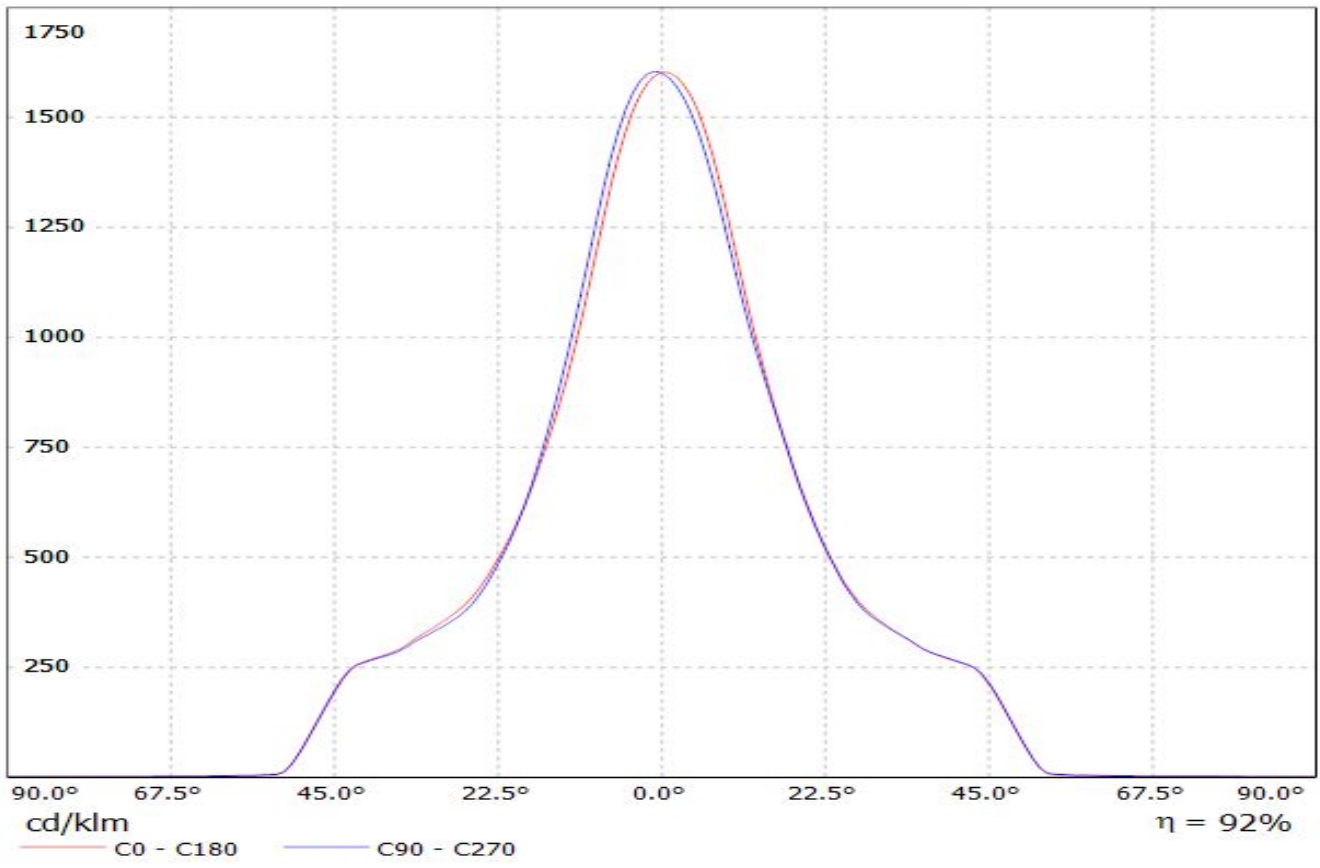

Luminaire: LEDiL Oy F13401_ANGELINA-M_(MEGAZENIGATA) Eff.92.5%
Lamps: 1 x SHARP_MEGAZENIGATA_(GW6DME30NFC)_1238.26lm@250mA_CCT=3000K_P=11.1211W_I=249.8mA

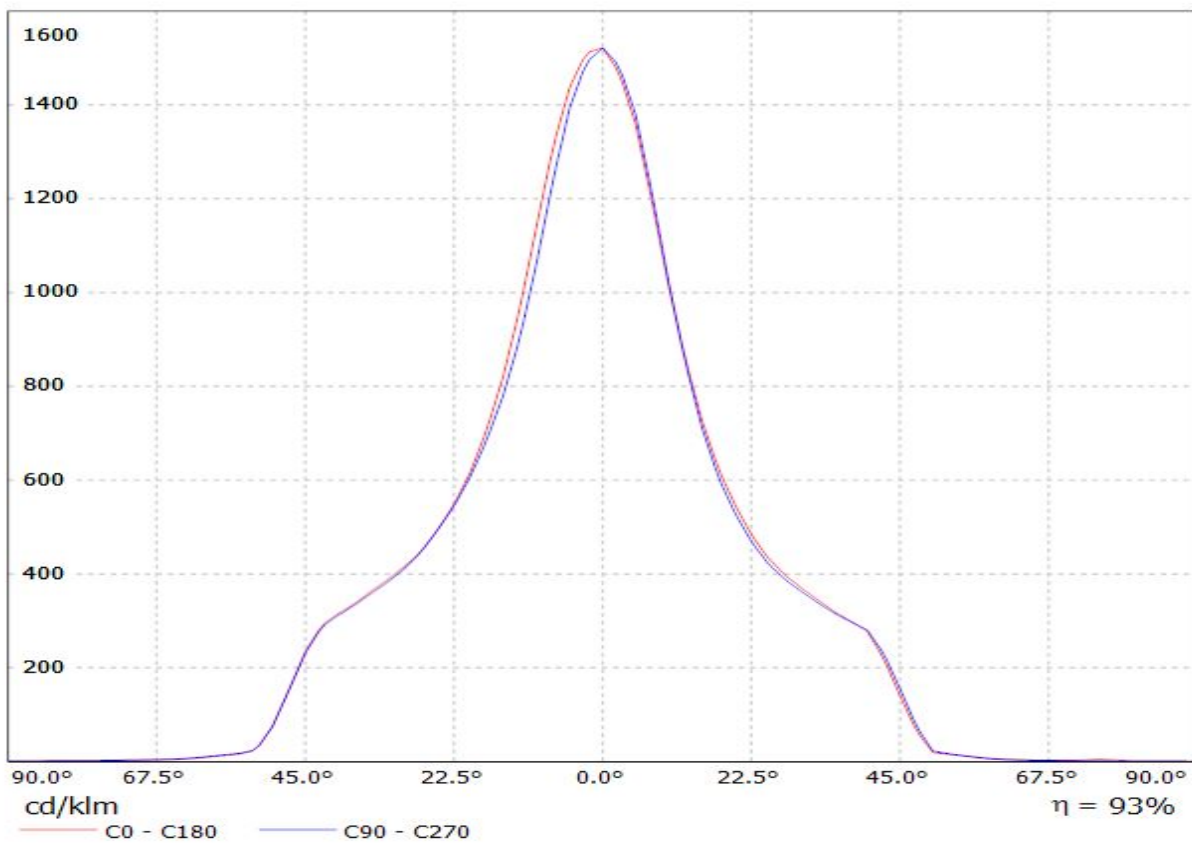

Luminaire: LEDiL Oy F13401_ANGELINA-M_(STARK_SLE_G2_LES19) Eff.91.6%
Lamps: 1 x TRIDONIC STARK SLE G2 LES19 830 CLA 964.643lm@250mA CCT=3000K P=8W I=250mA

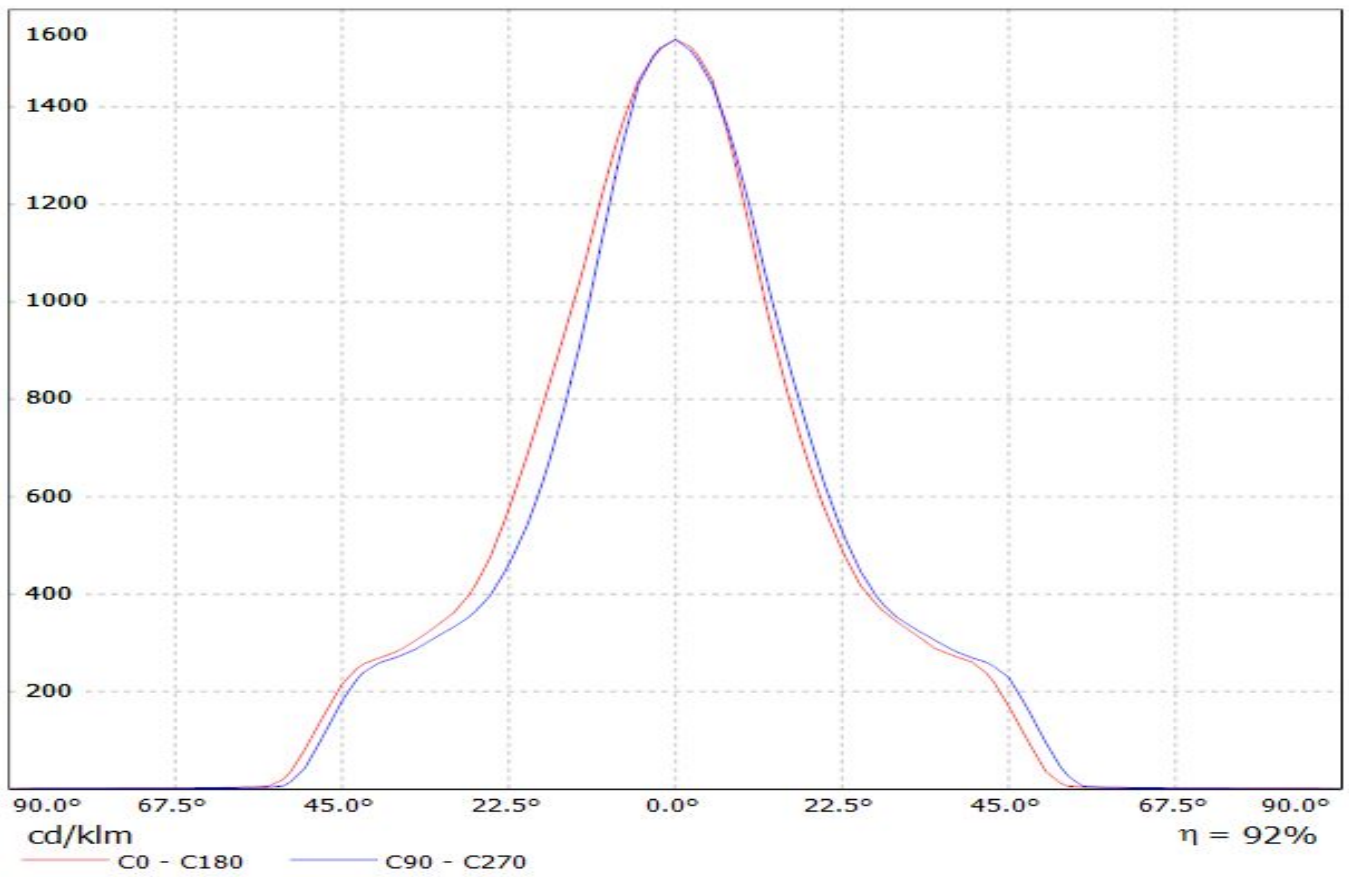

Luminaire: LEDiL Oy F13401_ANGELINA-M_(STARK_SLE_G2_LES23) Eff.90.2%
Lamps: 1 x TRIDONIC STARK SLE G2 LES23 830 CLA 982.731lm@250mA CCT=3000K P=8W I=250mA

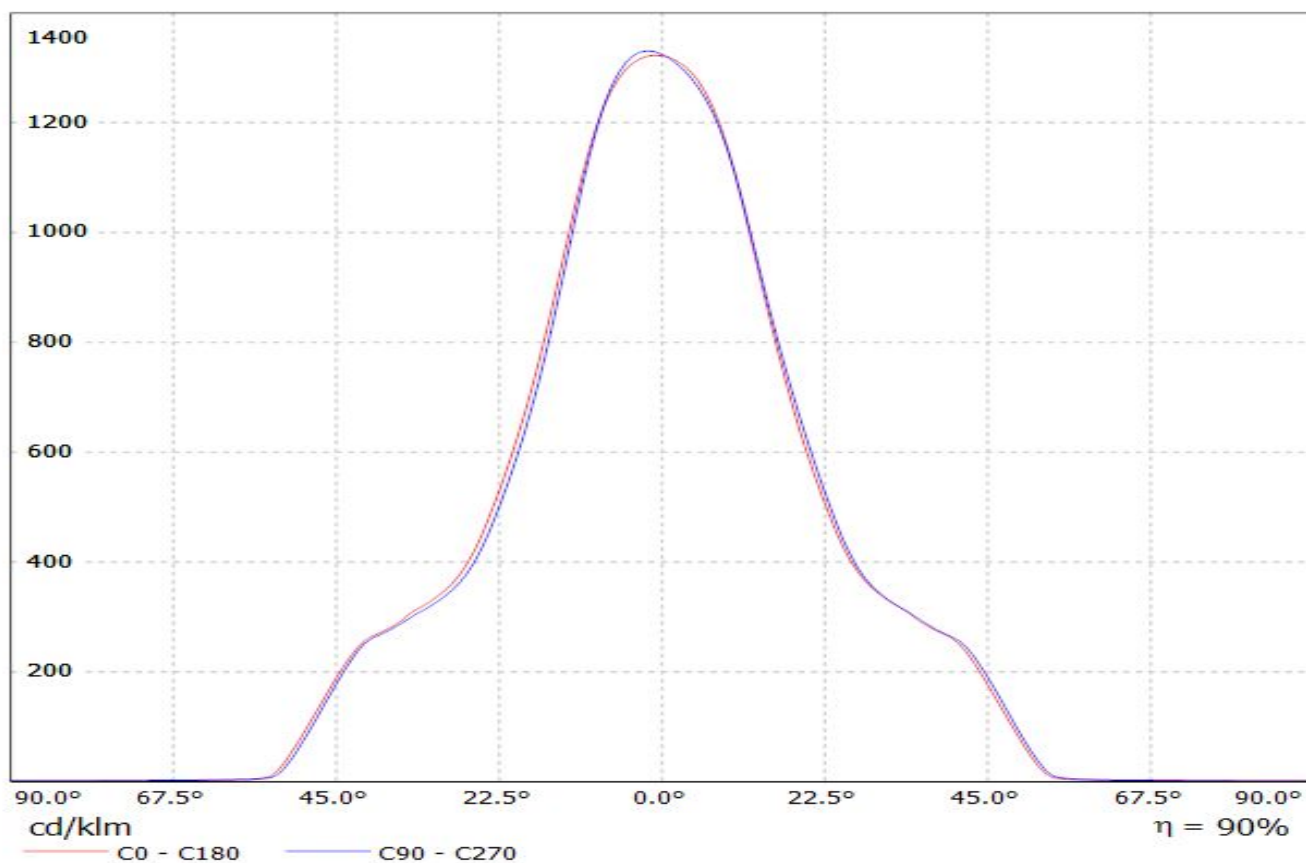

Luminaire: LEDiL Oy F13401_ANGELINA-M_(STARK_SLE_G2_LES26) Eff.89.0%
Lamps: 1 x TRIDONIC STARK SLE G2 LES26 830 CLA 1095.88lm@250mA CCT=3000K P=8W I=250mA

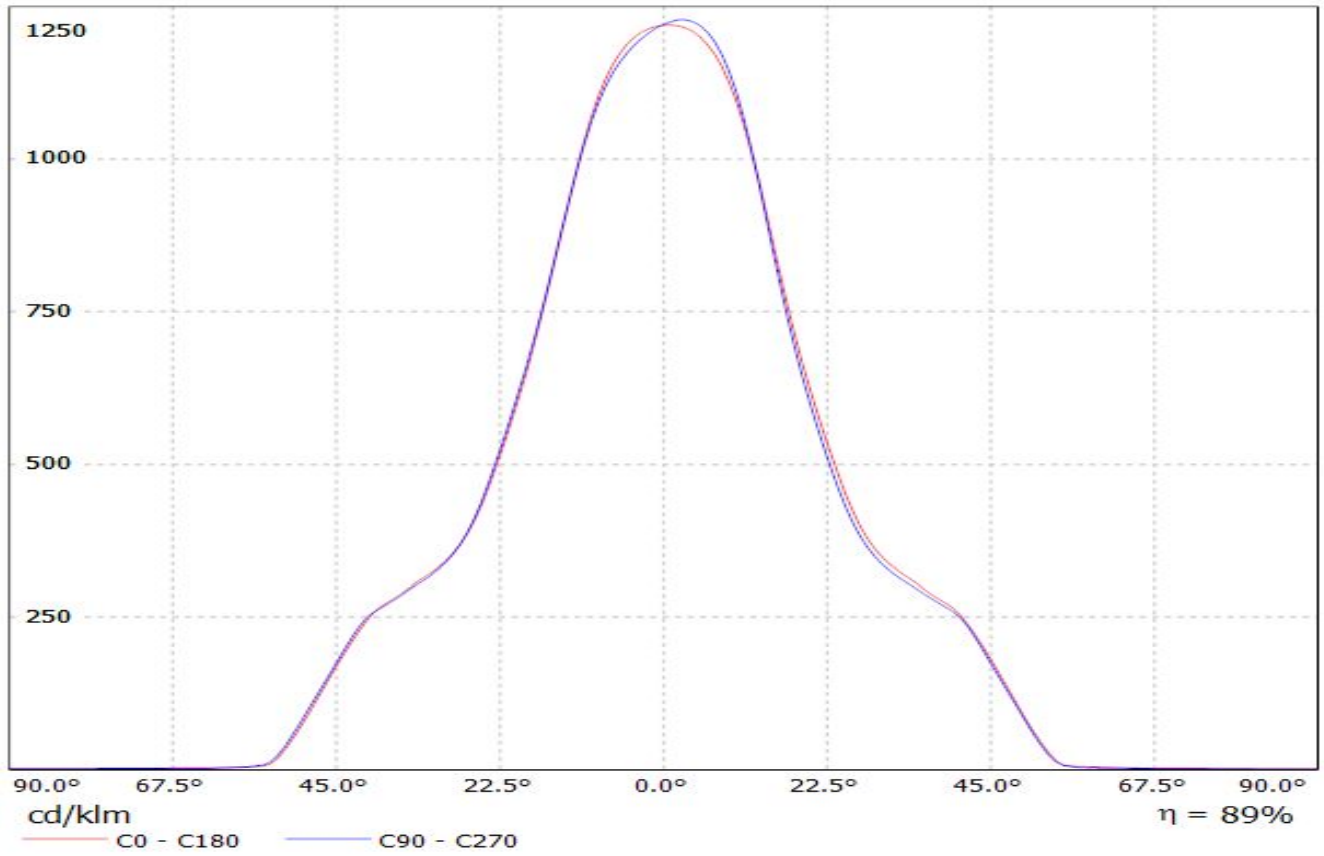

Luminaire: LEDiL Oy F13401_ANGELINA-M_(SLE_G3_LES19) Eff.92.1%

Lamps: 1 x TRIDONIC_STARK_SLE_G3_LES19_(STARK-SLE-G3-LES19-2000-840-CLA)_1058.33lm@250mA_P=8.32833W_I=249.8mA

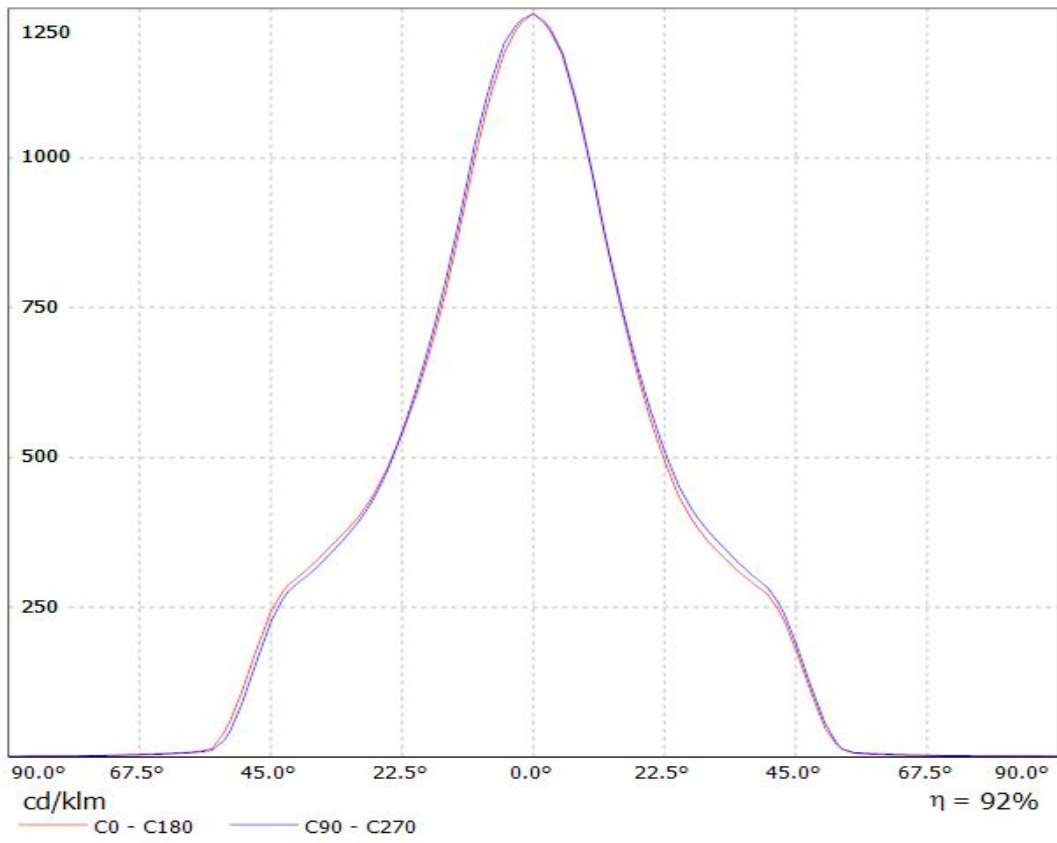

Luminaire: LEDiL Oy F13401_ANGELINA-M_(SLE_G3_LES23) Eff.90.0%

Lamps: 1 x TRIDONIC_STARK_SLE_G3_LES23_(STARK-SLE-PURE_G3-23-3000-930-SEL)_813.196lm@250mA_CCT=3000K_P=8.20018W_I=249.8mA

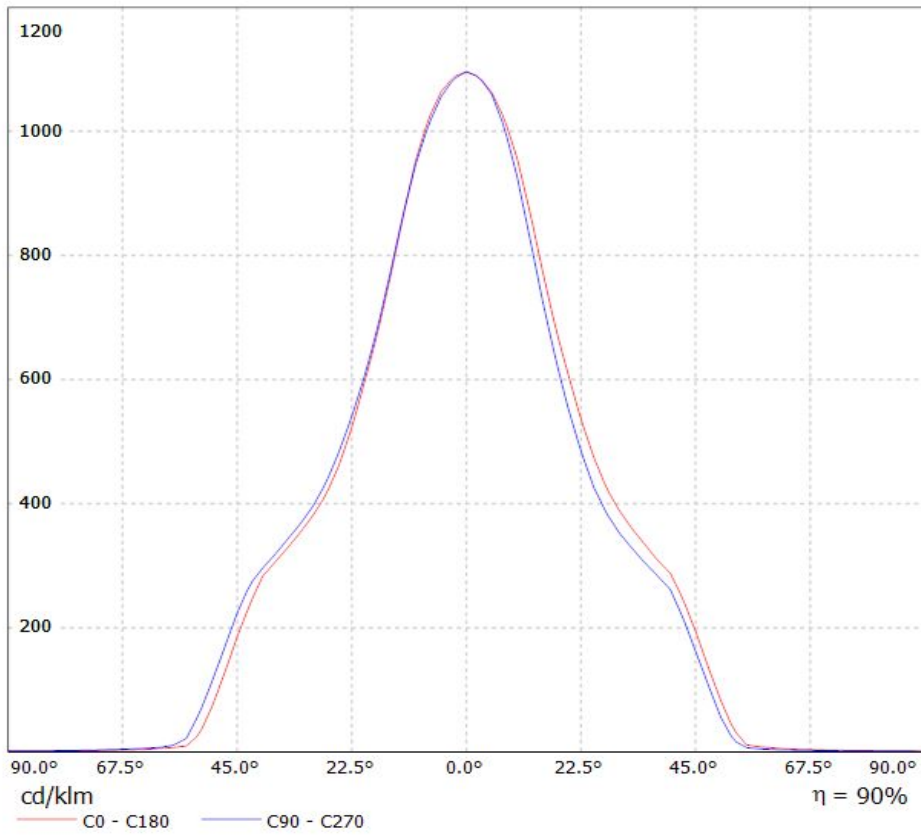

Luminaire: LEDiL Oy F13401_ANGELINA-M_(SLE_G4_LES23)

Lamps: 1 x Tridonic_SLE_G4_LES23_1354.57lm@250mA_P=8.18744W_I=0.2498A

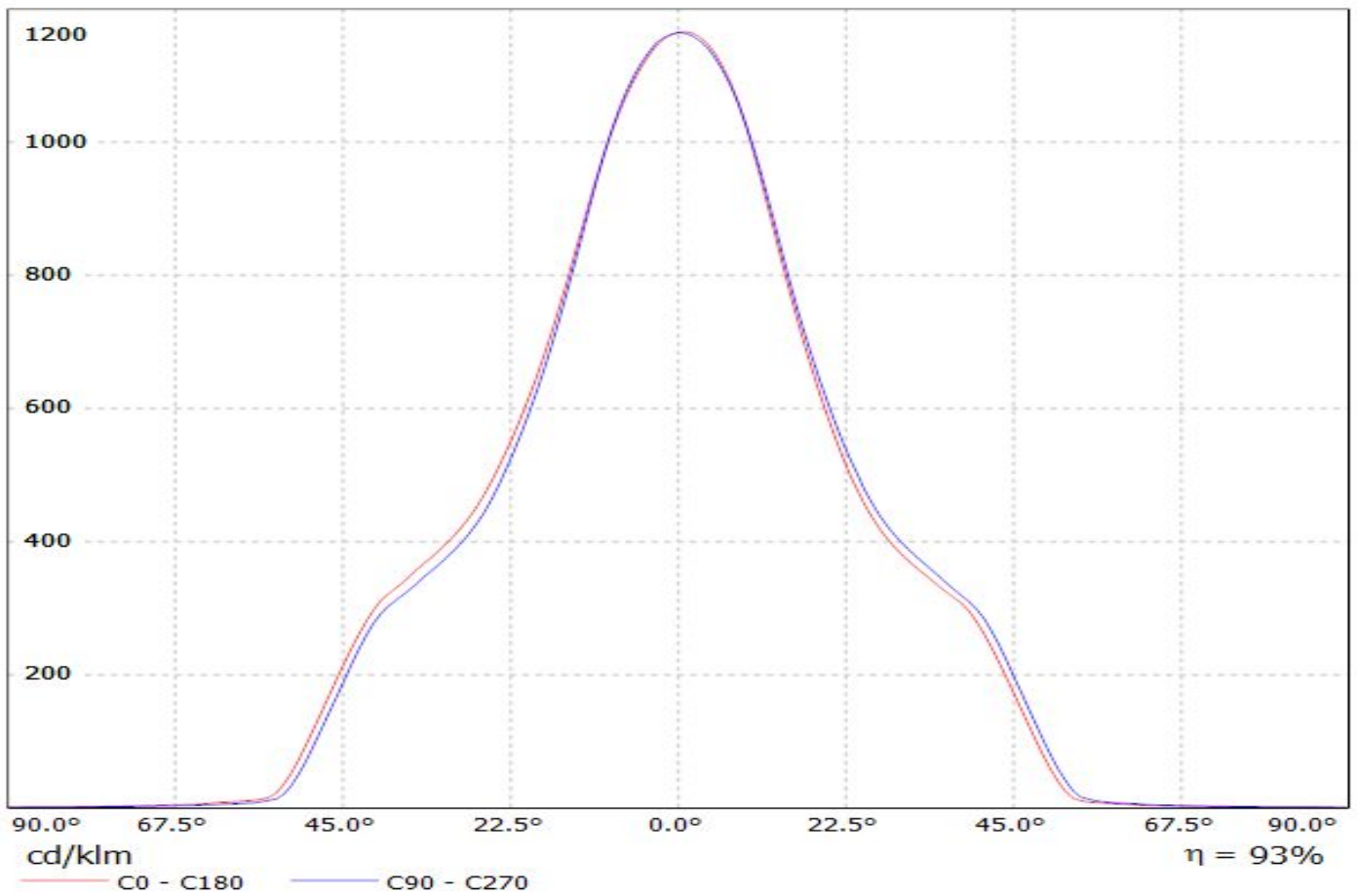

Luminaire: LEDiL Oy F13401_ANGELINA-M_(SLE GEN4 LES19)
Lamps: 1 x SLE GEN4 LES19_1226.28lm@250mA_P=8.21367W_I=0.2498A

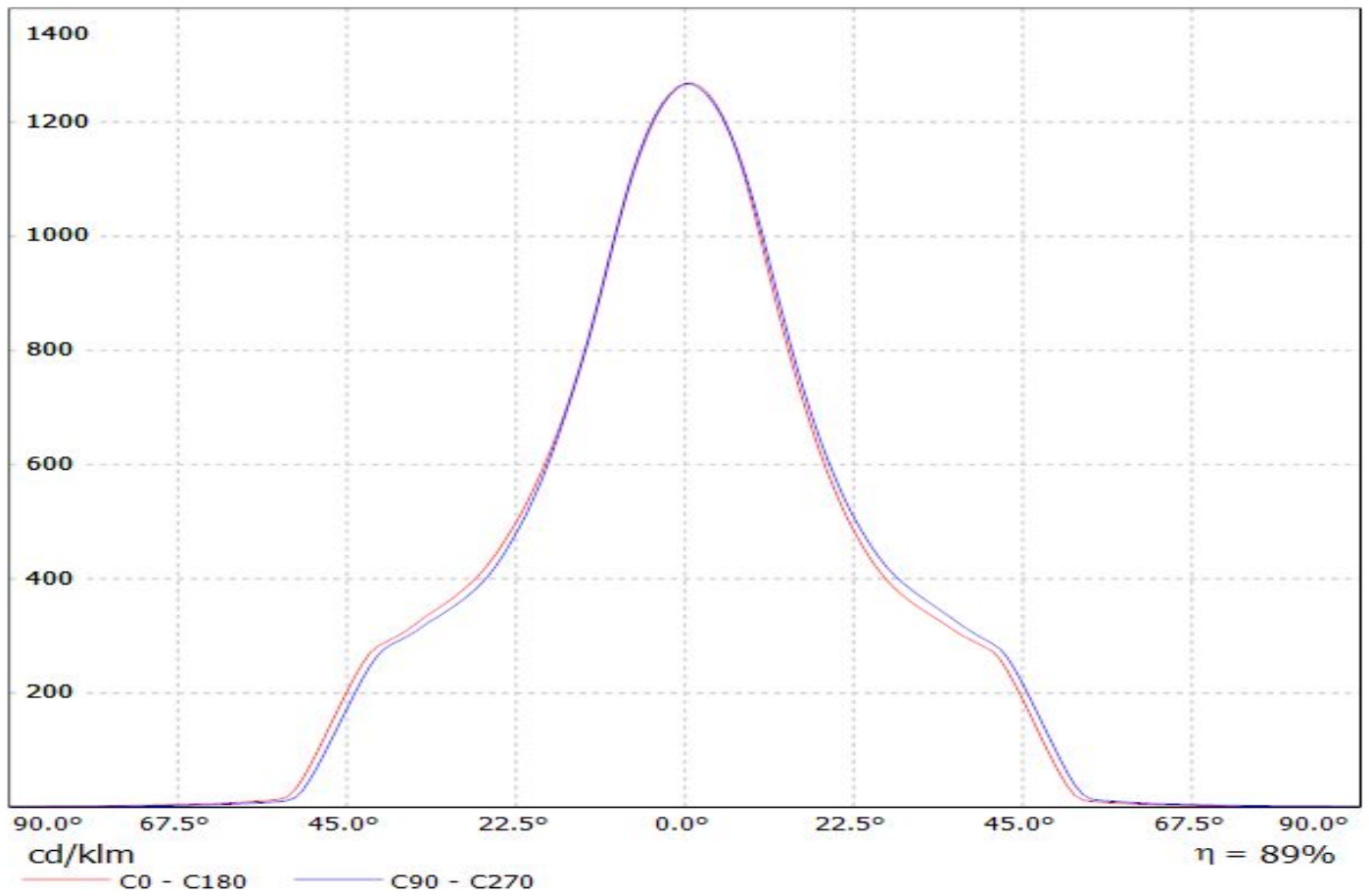

Luminaire: LEDiL Oy F13401_ANGELINA-M_(SLE-G5_LES-19)
Lamps: 1 x Tridonic_SLE-G5_LES-19_1287.79lm@250mA_P=8.2274W_I=0.250A

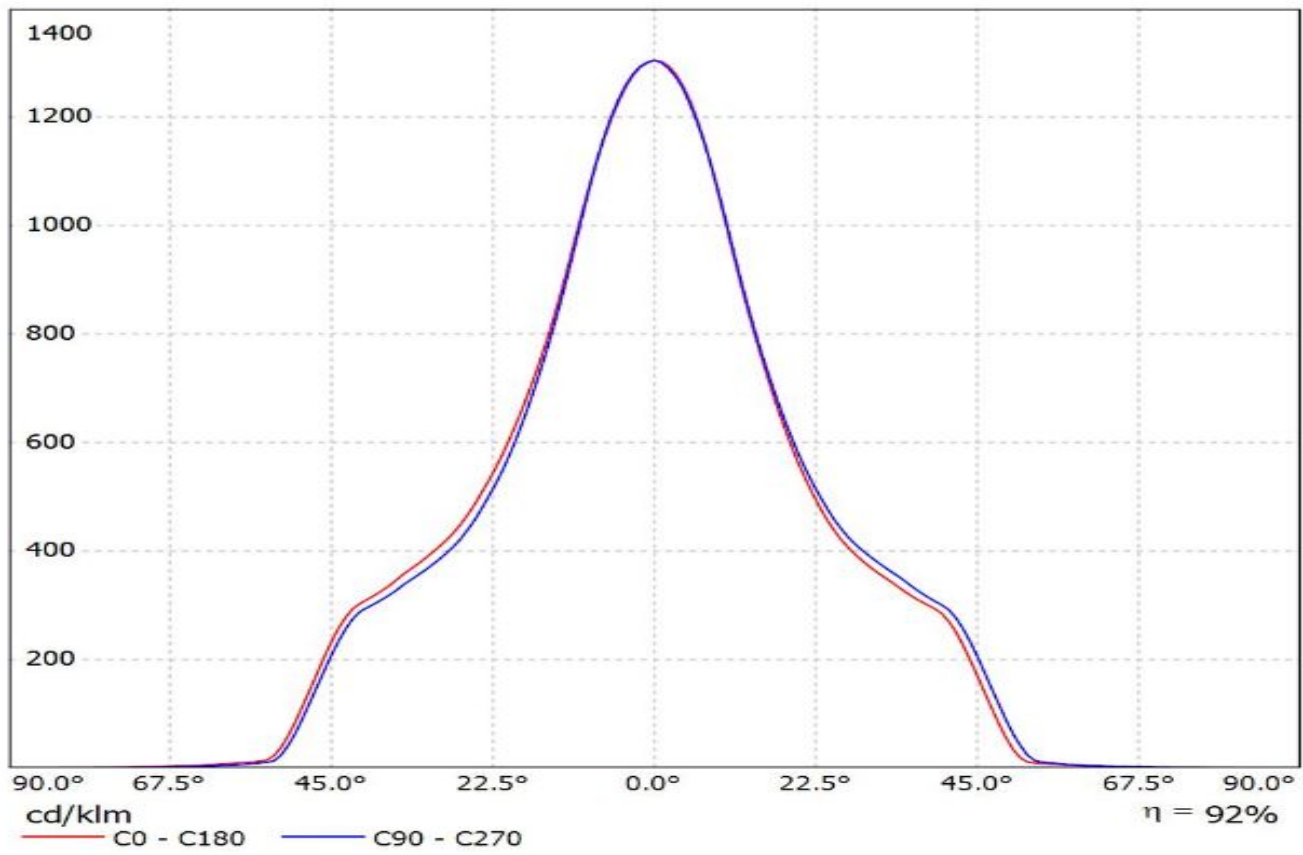

Luminaire: LEDiL Oy F13401_ANGELINA-M_(SLE-G5_LES-23)
Lamps: 1 x Tridonic_SLE-G5_LES-23_1303.96lm@250mA_P=8.1062W_I=0.250A

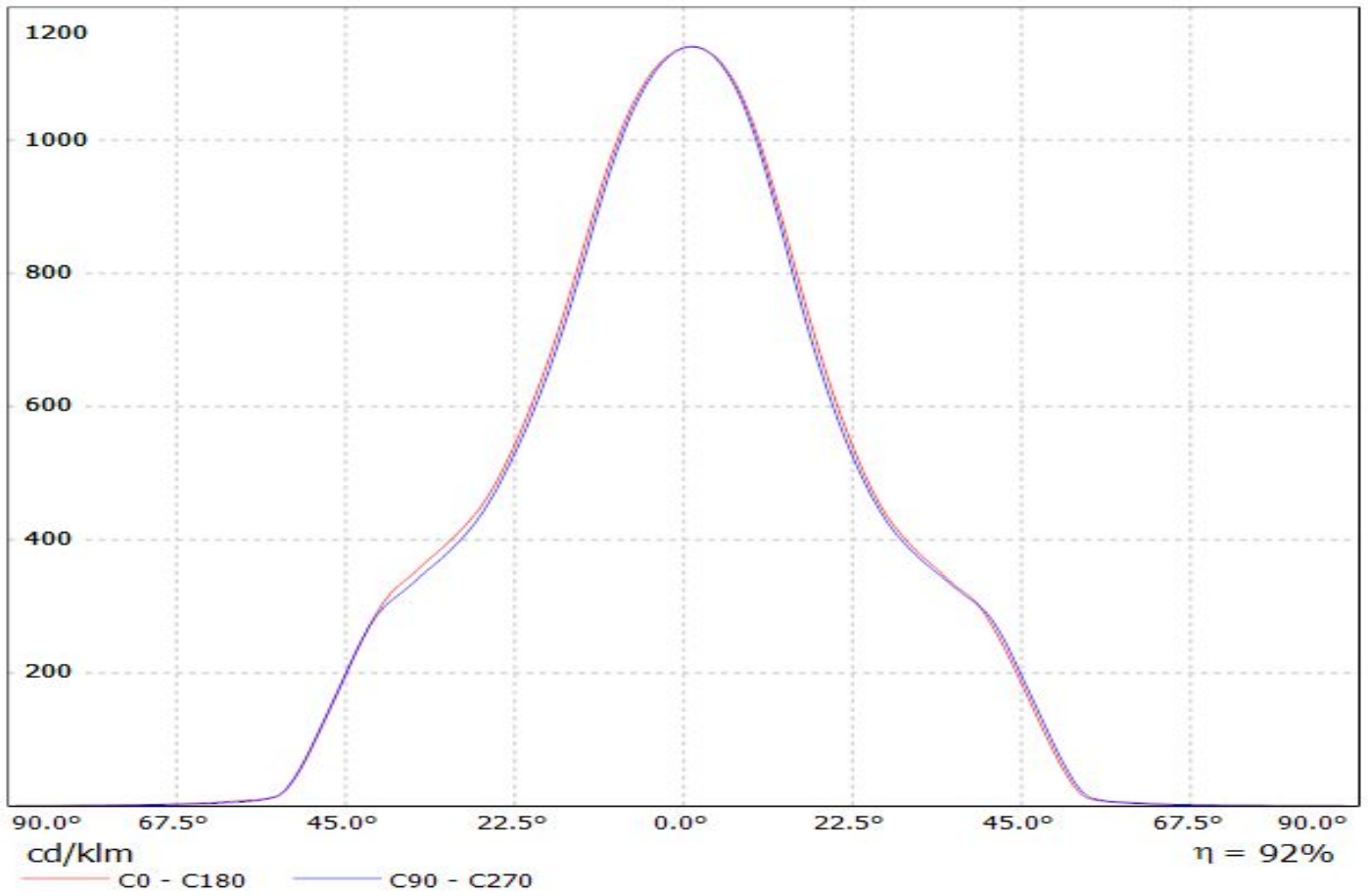

Luminaire: LEDiL Oy F13401_ANGELINA-M_(WU-M-461-827)
Lamps: 1 x Vossloh_WU-M-461-827_773.276lm@250mA_P=6.27423W_I=249.8mA

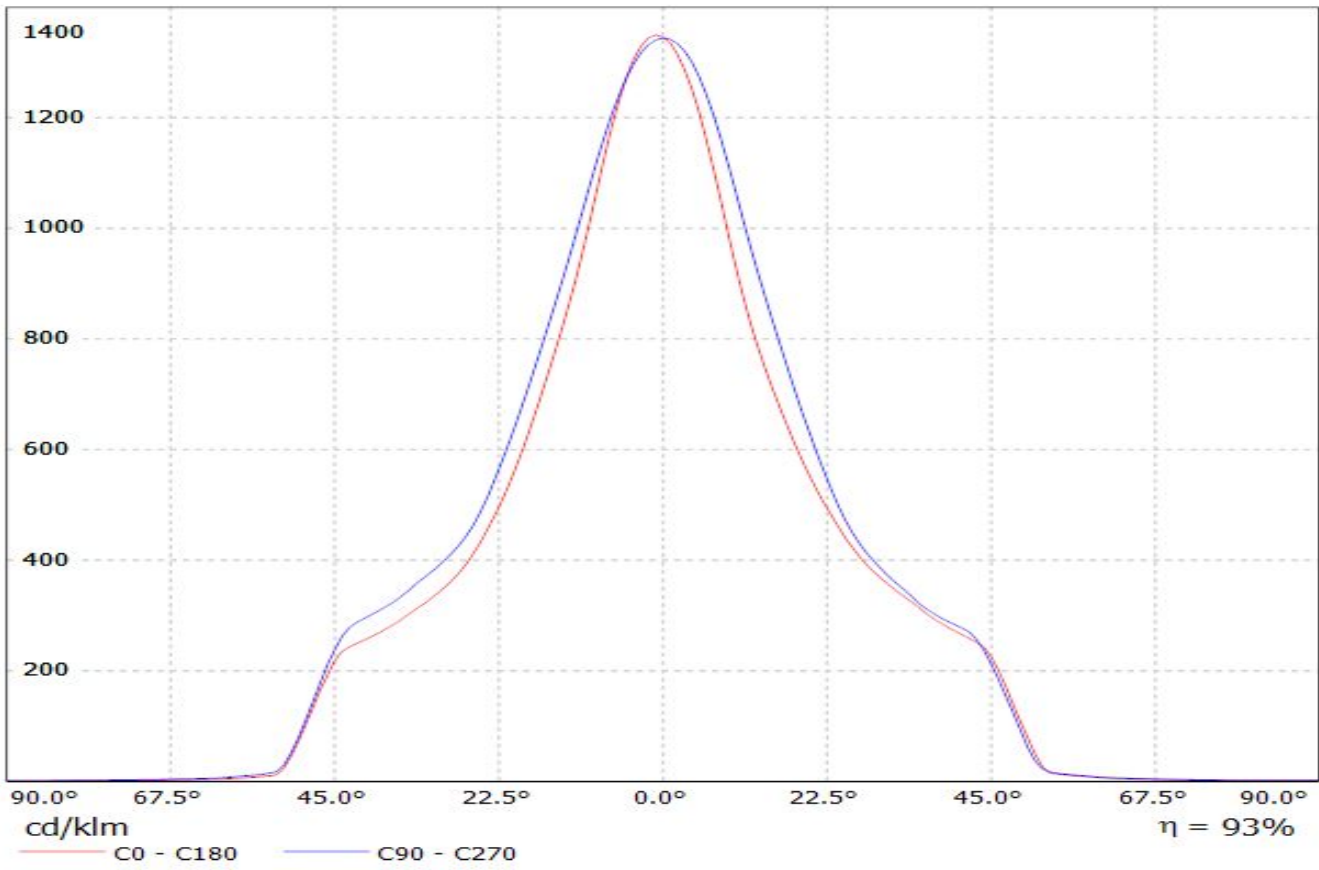

Luminaire: LEDiL Oy F13401_ANGELINA-M_(WU-M-462-827)

Lamps: 1 x Vossloh_WU-M-462-827_1116.7lm@250mA_P=8.9943W_I=249.8mA

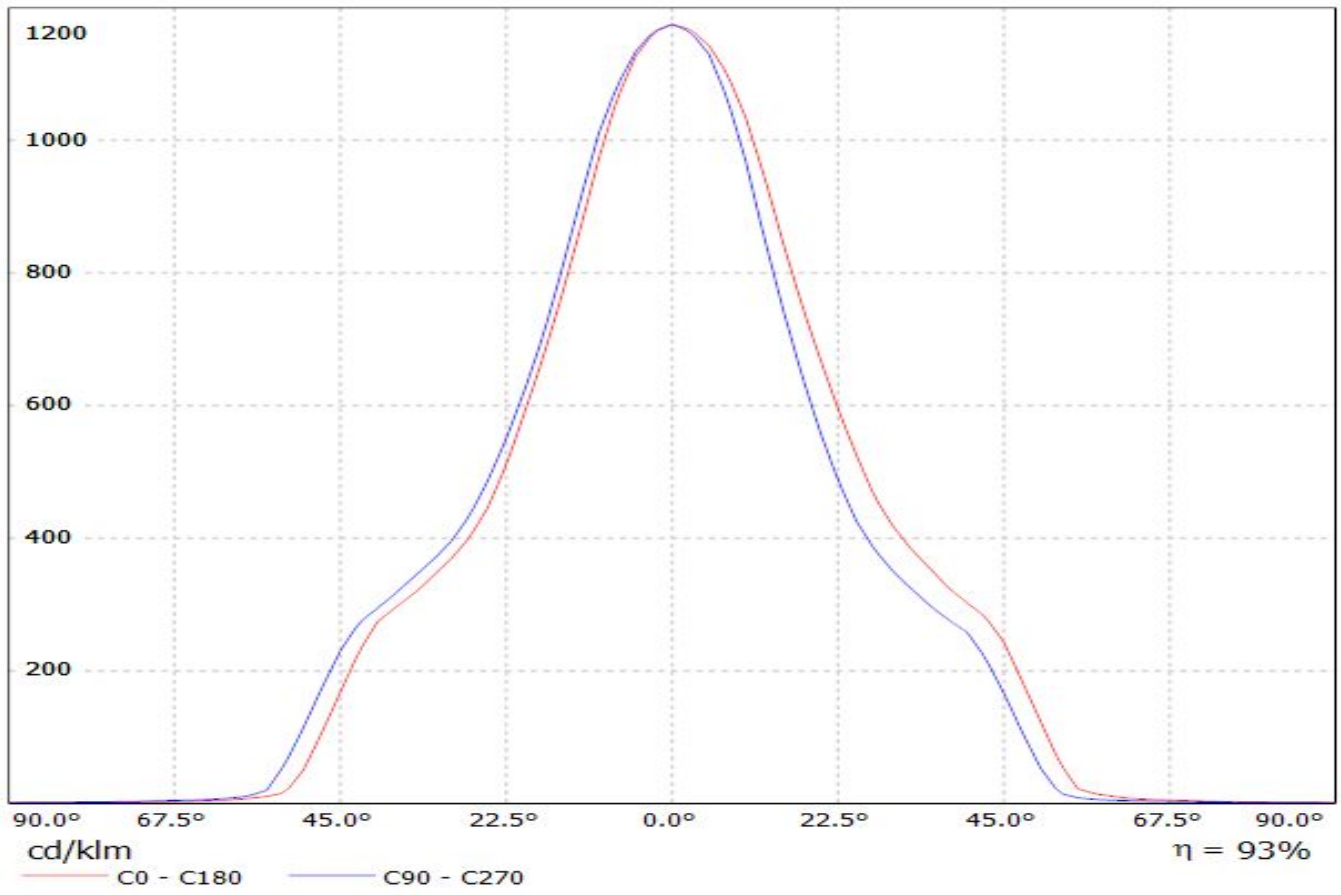

Luminaire: LEDiL Oy F13401_ANGELINA-M_(WU-M-464-827)

Lamps: 1 x Vossloh_WU-M-464-827_1452.93lm@250mA_P=11.6939W_I=249.8mA

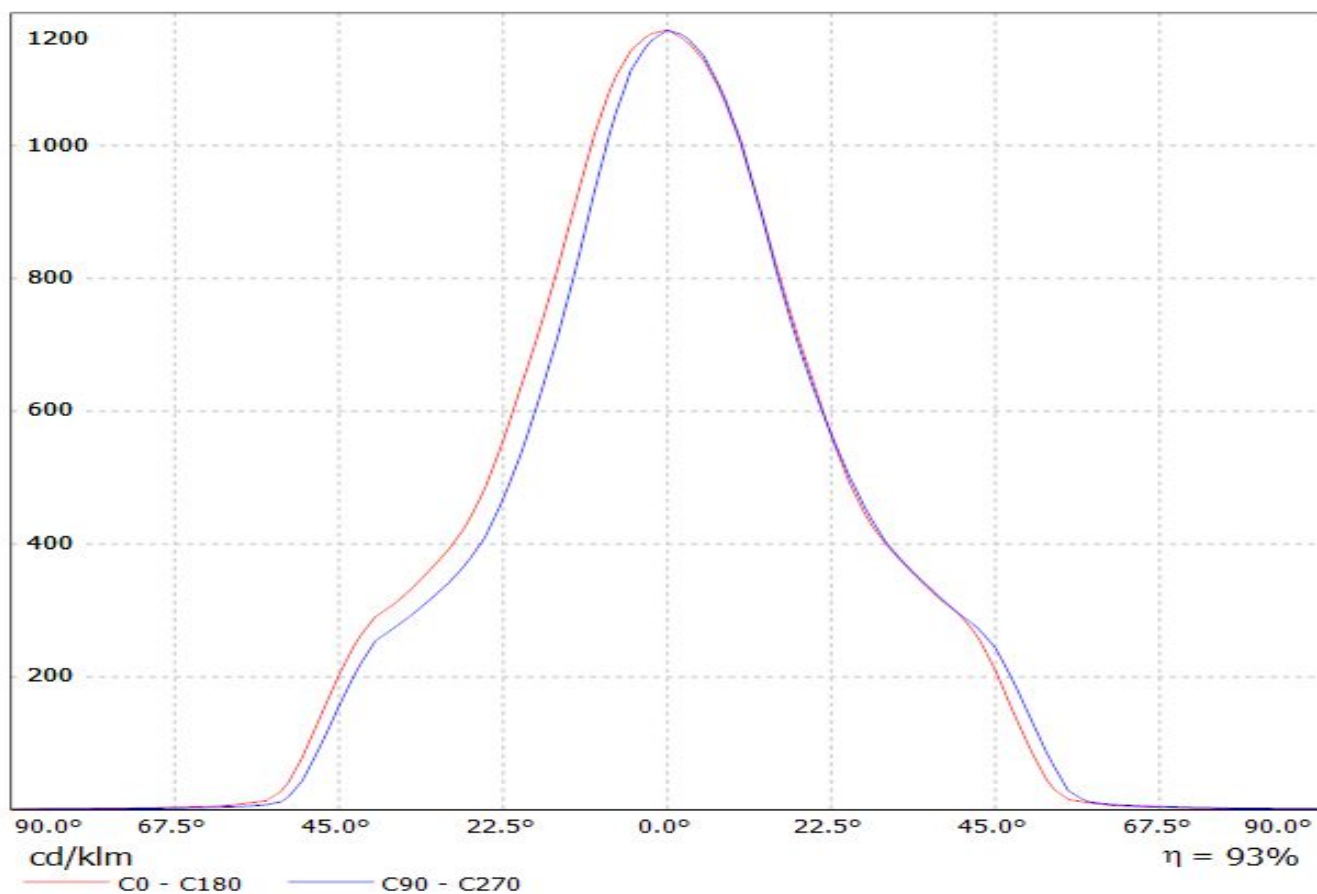

Luminaire: LEDiL Oy F13401_ANGELINA-M_(WU-M-484)

Lamps: 1 x Vossloh_Schwabe-WU-M-484_(WU-M-484-830)_657.125lm@250mA_P=5.59976W_I=249.9mA

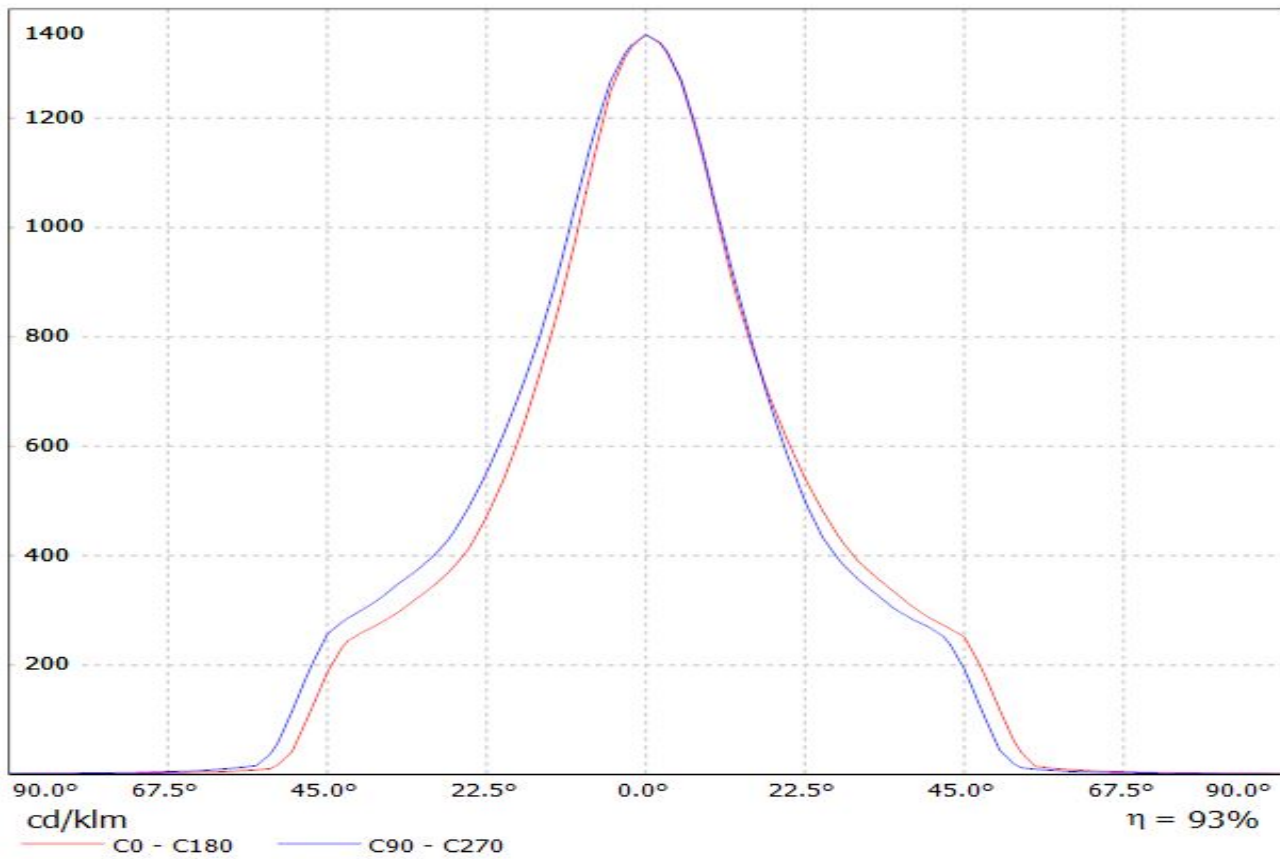

Luminaire: LEDiL Oy F13401_ANGELINA-M_(WU-M-485)

Lamps: 1 x Vossloh_Schwabe-WU-M-485_(WU-M-485-830)_1209.62lm@250mA_P=8.43849W_I=249.8mA

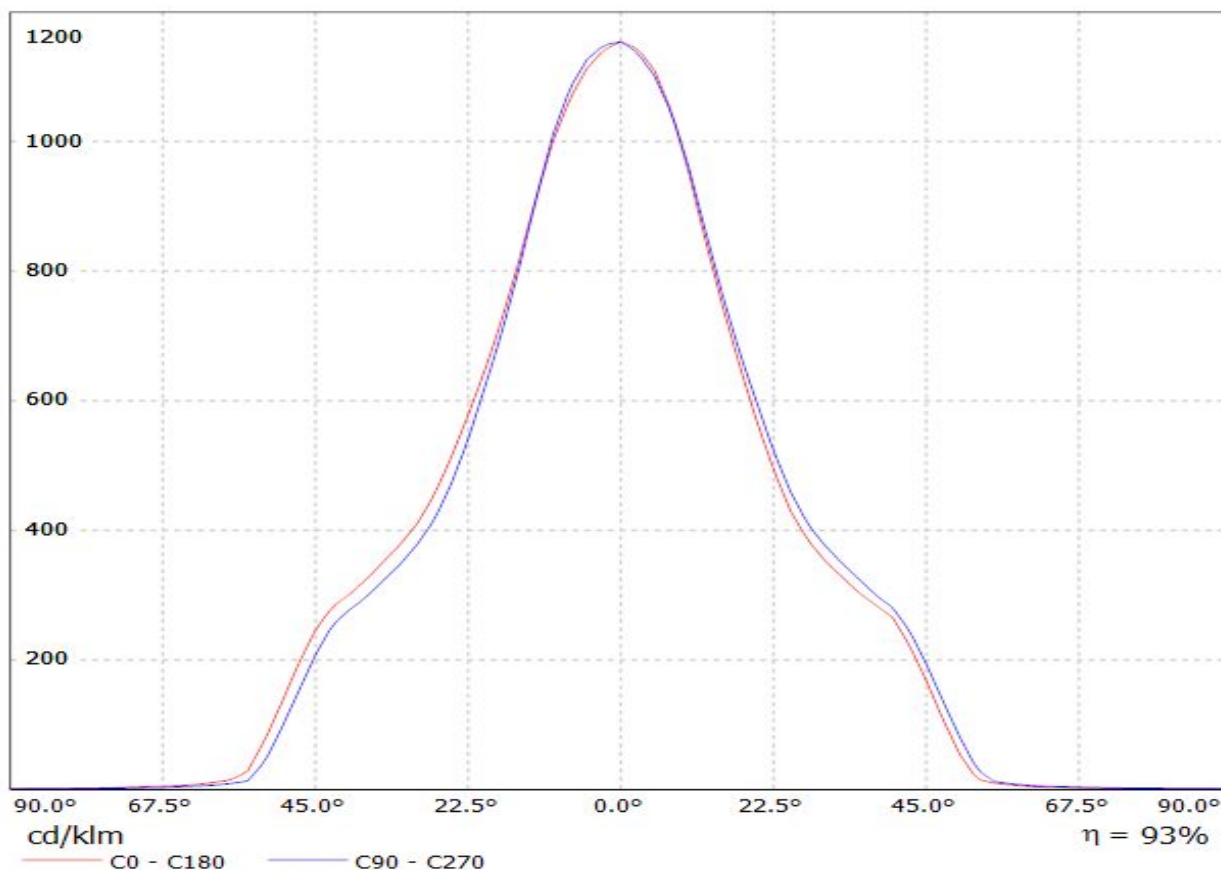

Luminaire: LEDiL Oy F13401_ANGELINA-M_(WU-M-486) Eff.92.1%
Lamps: 1 x Vossloh_Schwabe-WU-M-486_(WU-M-486-830)
_1474.55lm@250mA_P=10.4456W_I=249.8mA

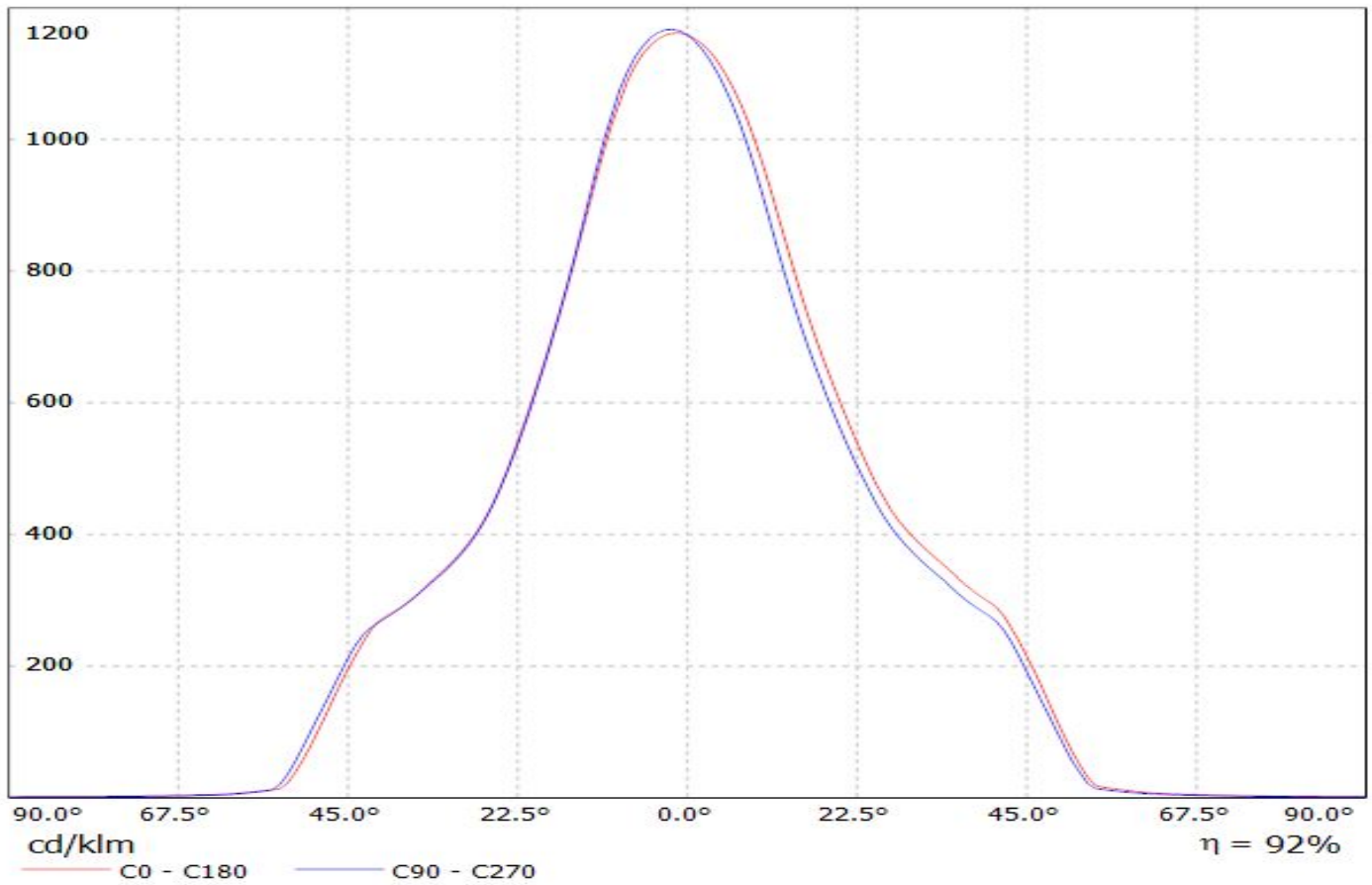

Luminaire: LEDiL Oy F13401_ANGELINA-M_(BXRA_ES) Eff.92.6%

Lamps: 1 x BXRA_ES_(BXRA-W1203_102820-3110)_281.549lm@250mA_P=4.09397W_I=249.8mA

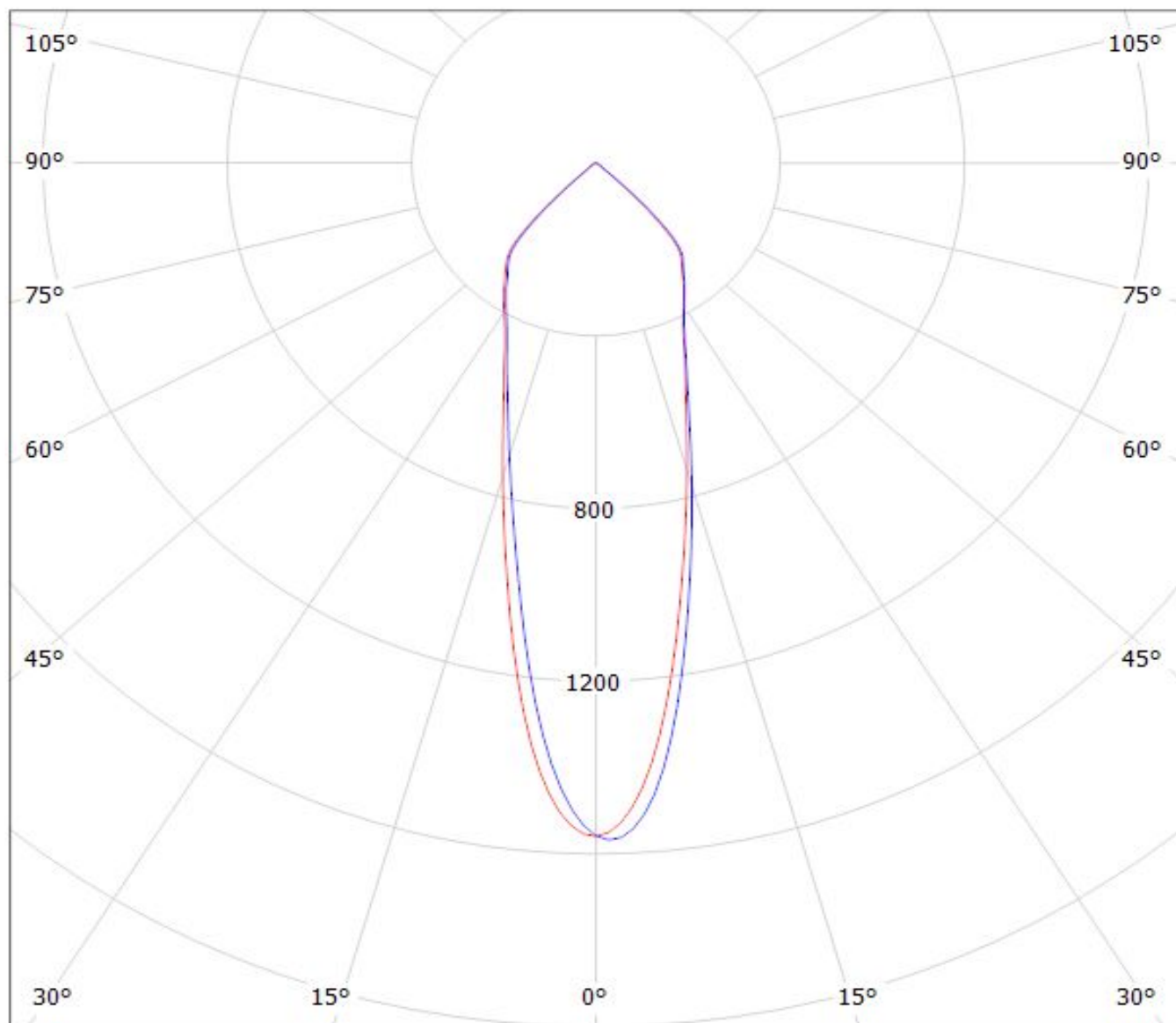

cd/klm

— C0 - C180

— C90 - C270

$\eta = 93\%$

LABORATORY 10: THE HEMISPHERICAL PROJECTION

NAME: _____ DATE: _____

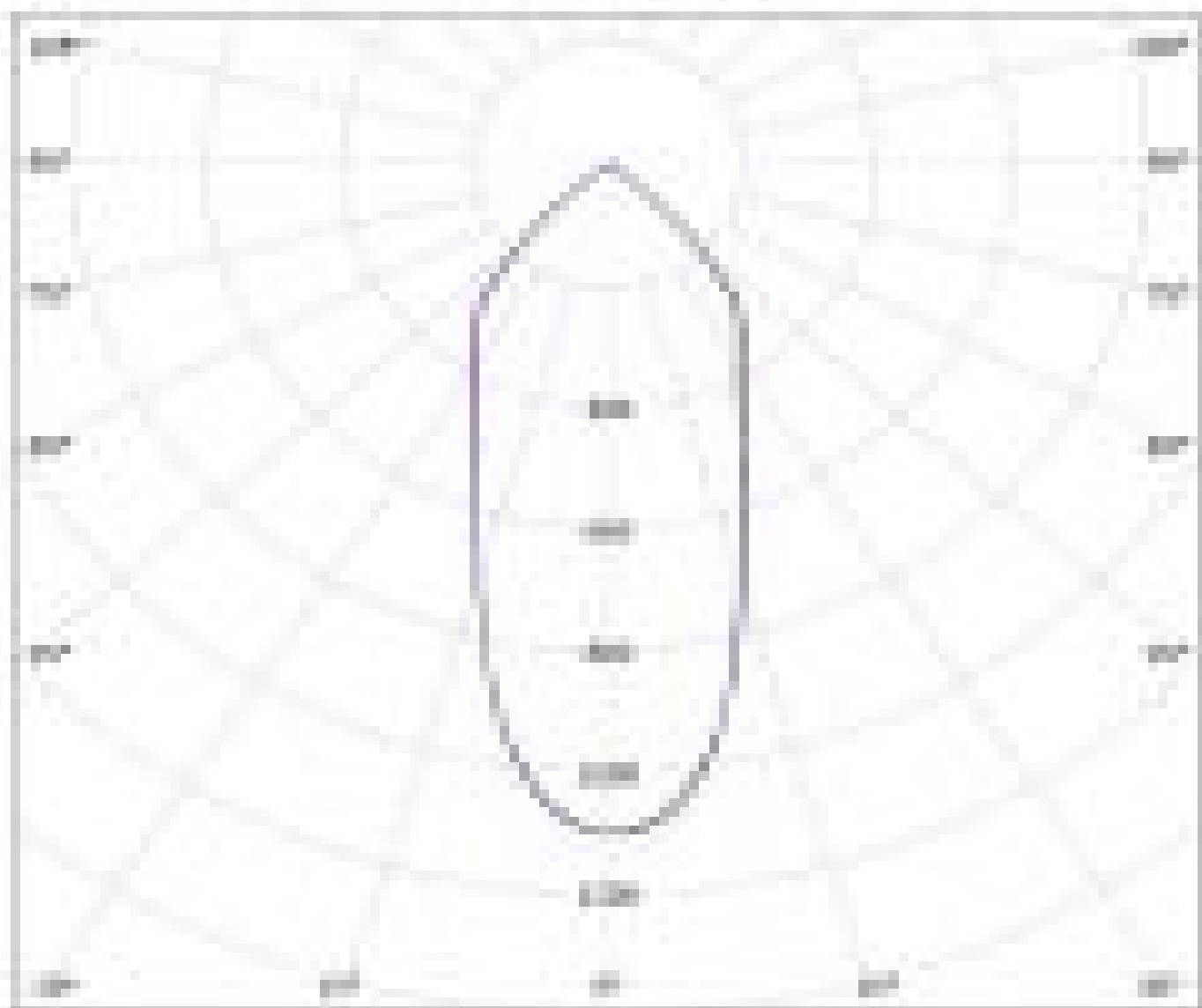

0° 180°

10 100 1000

Luminaire: LEDiL Oy F13401_ANGELINA-M_(V13_Gen7)+TE

Lamps: 1 x Bridgelux_V13_Gen7_(BXRE-30E2000-B_+TE_2213254-2+TE_2213194-1)_1295.55lm@250mA_P=8.30985W_I=0.25A

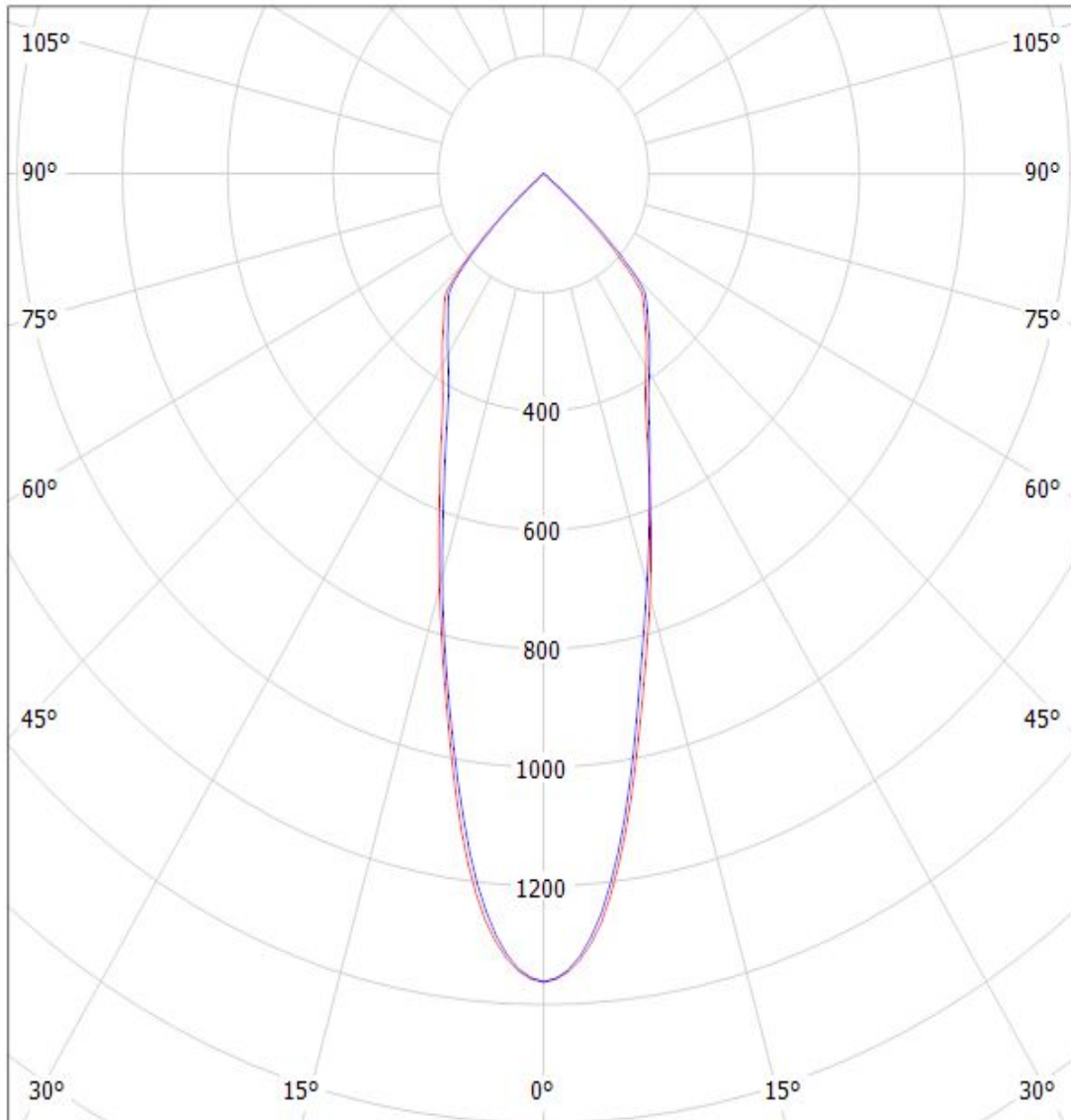

cd/klm

— C0 - C180 — C90 - C270

$\eta = 92\%$

Luminaire: Ledil Oy F13401_ANGELINA-M_Bridgelux_V22_Gen7_SIMULATED F13401_ANGELINA-M_Bridgelux_V22_Gen7_SIMULATED
Lamps: 1 x F13401_ANGELINA-M_Bridgelux_V22_Gen7_SIMULATED

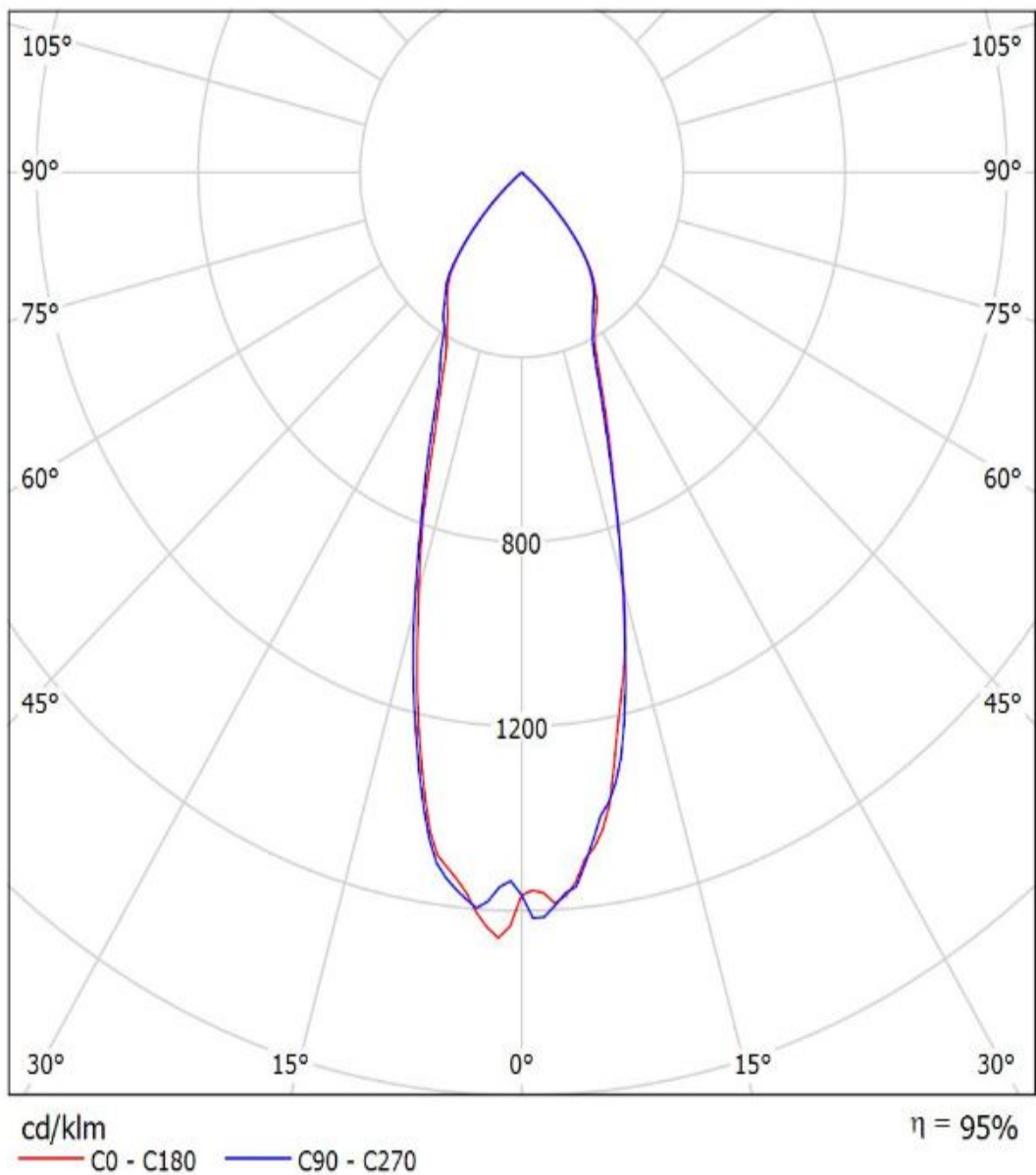

Luminaire: LEDiL Oy F13401_ANGELINA-M_(CLL030) Eff.92.3%

Lamps: 1 x CITIZEN_CLL030_(CLL030-1205A5-303H1A7)_758.588lm@250mA_CCT=5090K_P=8.61086W_I=249.8mA

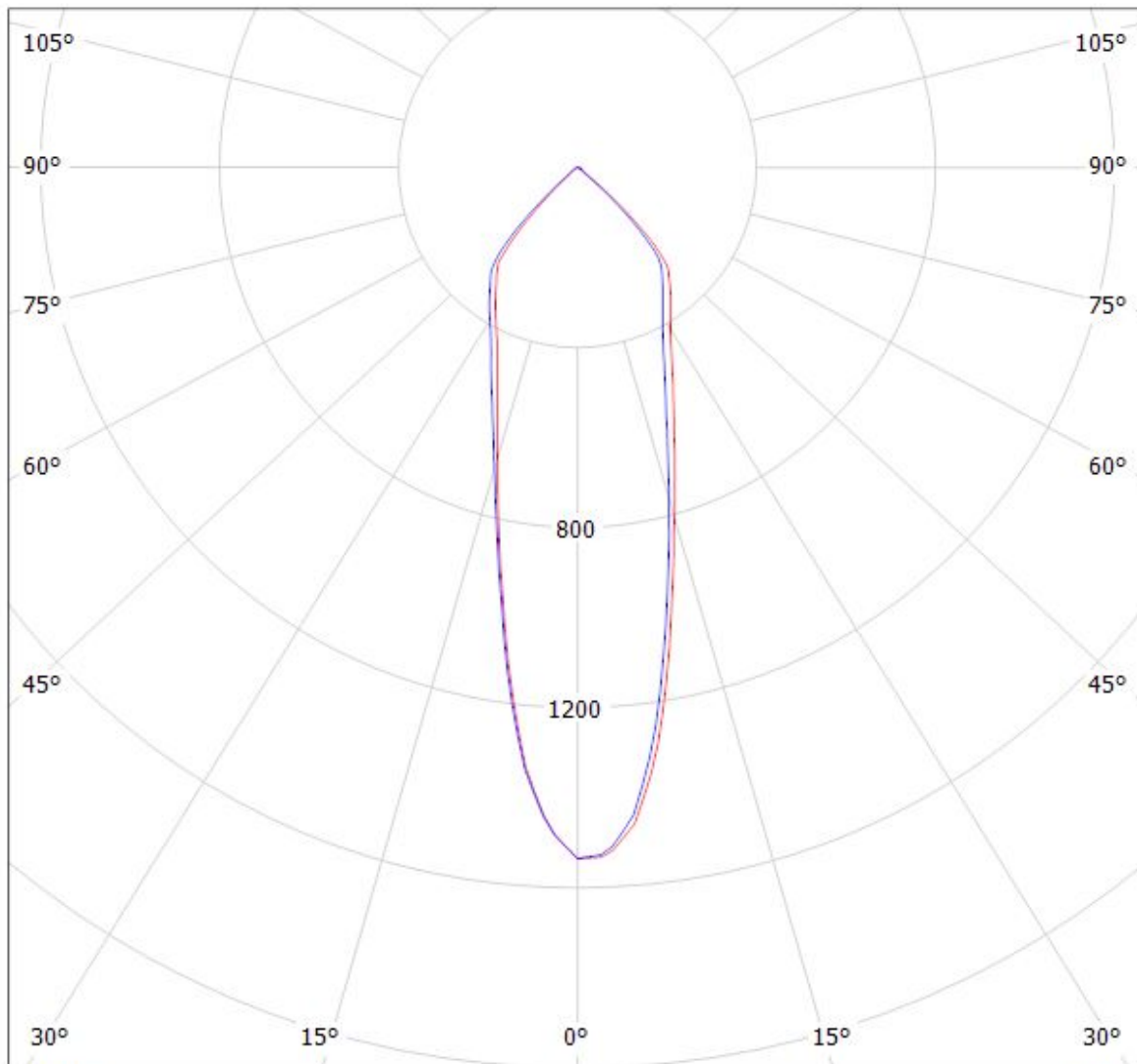

cd/klm

$\eta = 92\%$

— C0 - C180

— C90 - C270

Luminaire: LEDiL F13401_ANGELINA-M_(CLL030)

Lamps: 1 x CLL030 740lm@250mA (CLL030-1205A5-303H1A7) CCT:3000K P:8.6W

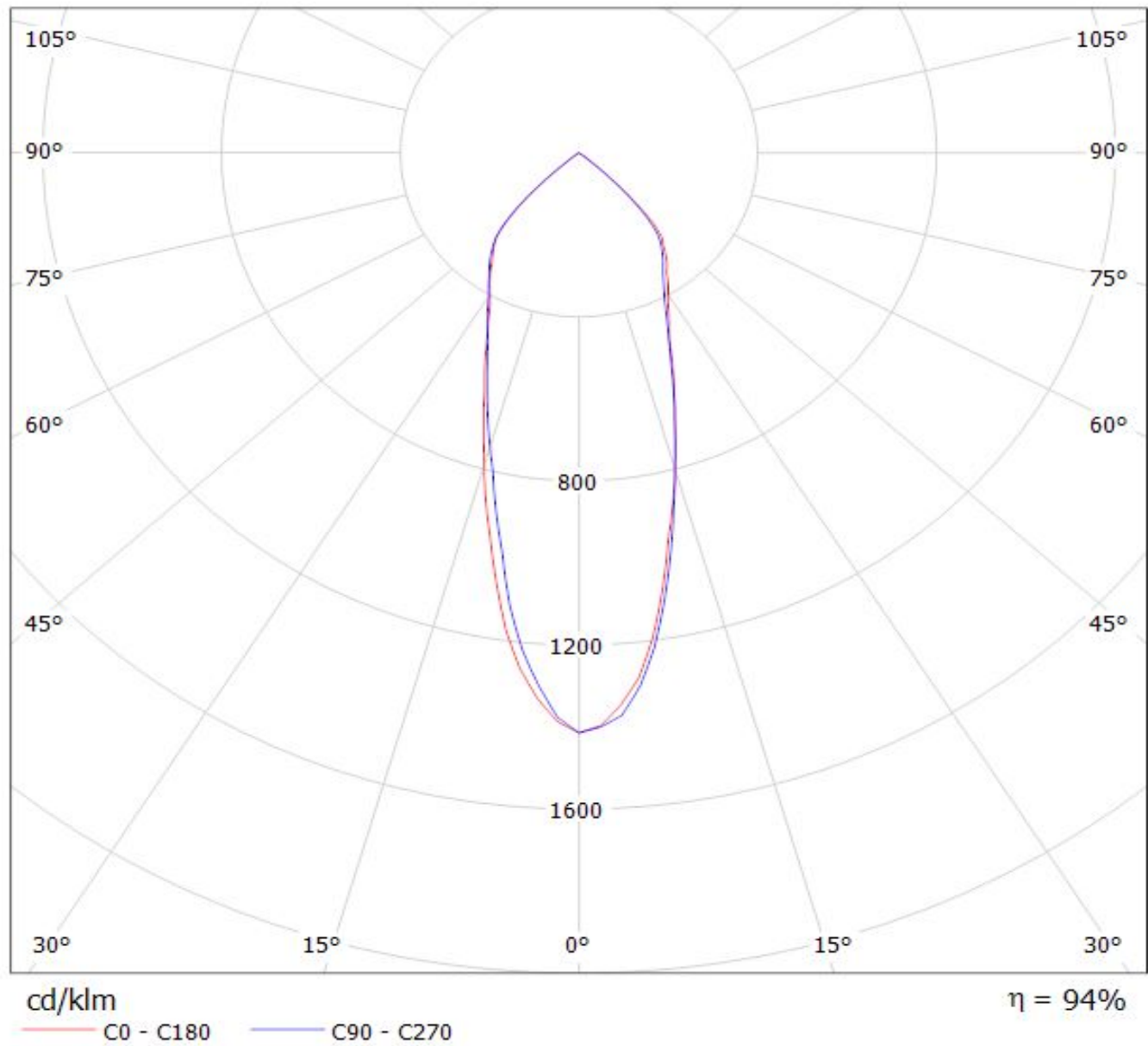

Luminaire: Ledil F13401_ANGELINA-M (CLU720)
Lamps: 1 x CITIZEN_CLU720 (CLU720-1206B8-273M2)
_1337.27lm@250mA_CCT=2700K_P=8.35W_I=0.25A

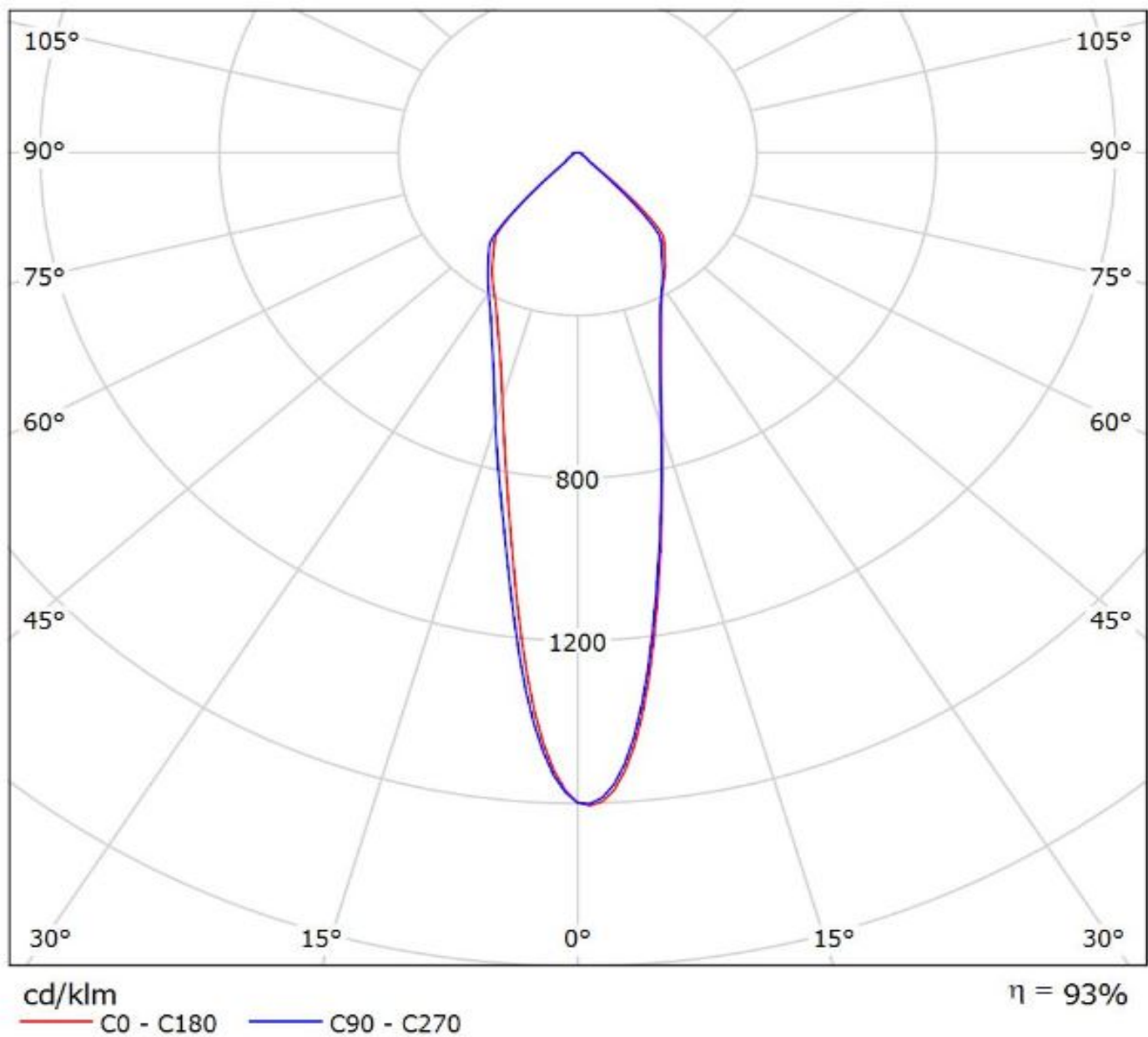

Ledil F13401_ANGELINA-M_(CLU720) / LDC (Polar)

Luminaire: Ledil F13401_ANGELINA-M_(CLU720)
Lamps: 1 x CITIZEN_CLU720_(CLU720-1206B8-273M2)
_1340.38lm@250mA_CCT=2700K_P=8.35W_I=0.25A

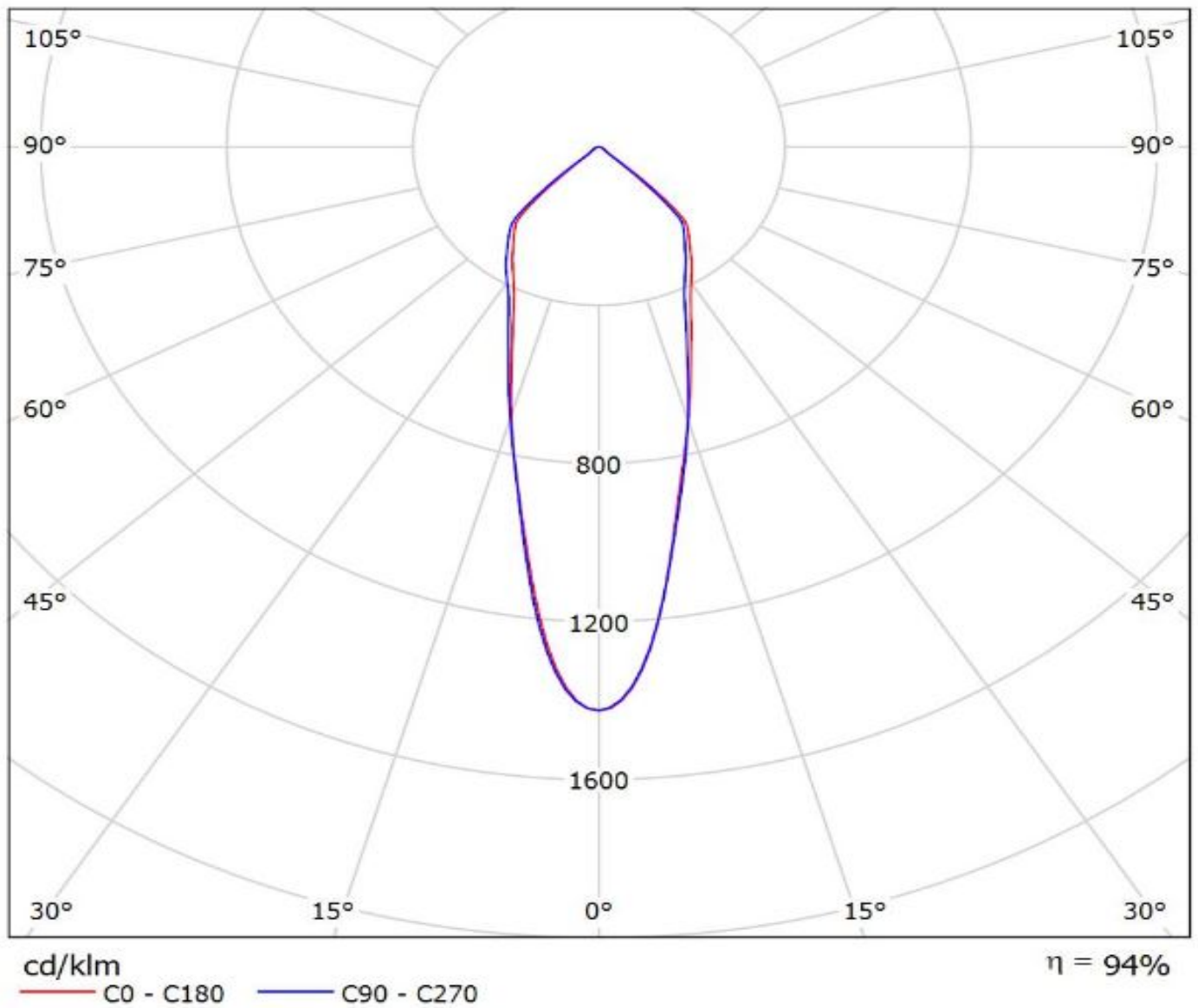

Luminaire: Ledil F13401_ANGELINA-M (CLU046+IDEAL)

Lamps: 1 x Citizen_CLU046_(-1212C1-303M2G2)_1383.92lm@250mA_CCT=3000K_P=8.122W_I=0.25A

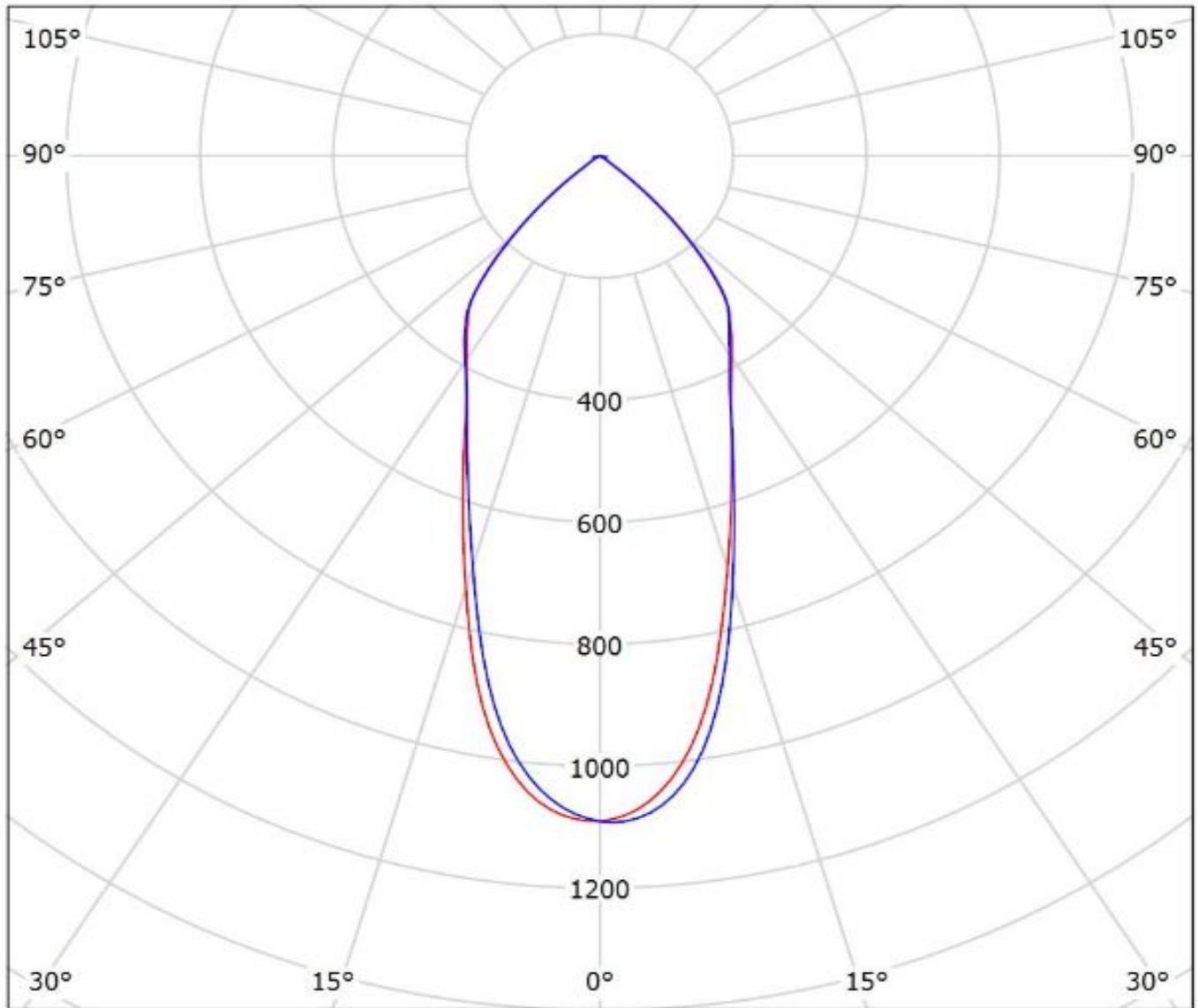

cd/klm

— C0 - C180 — C90 - C270

$\eta = 91\%$

Luminaire: Ledil F13401_ANGELINA-M_(CLU730+IDEAL)

Lamps: 1 x Citizen_CLU730_(-1210B8-273M2G1)_IDEAL_50-2204C+50-2100AN

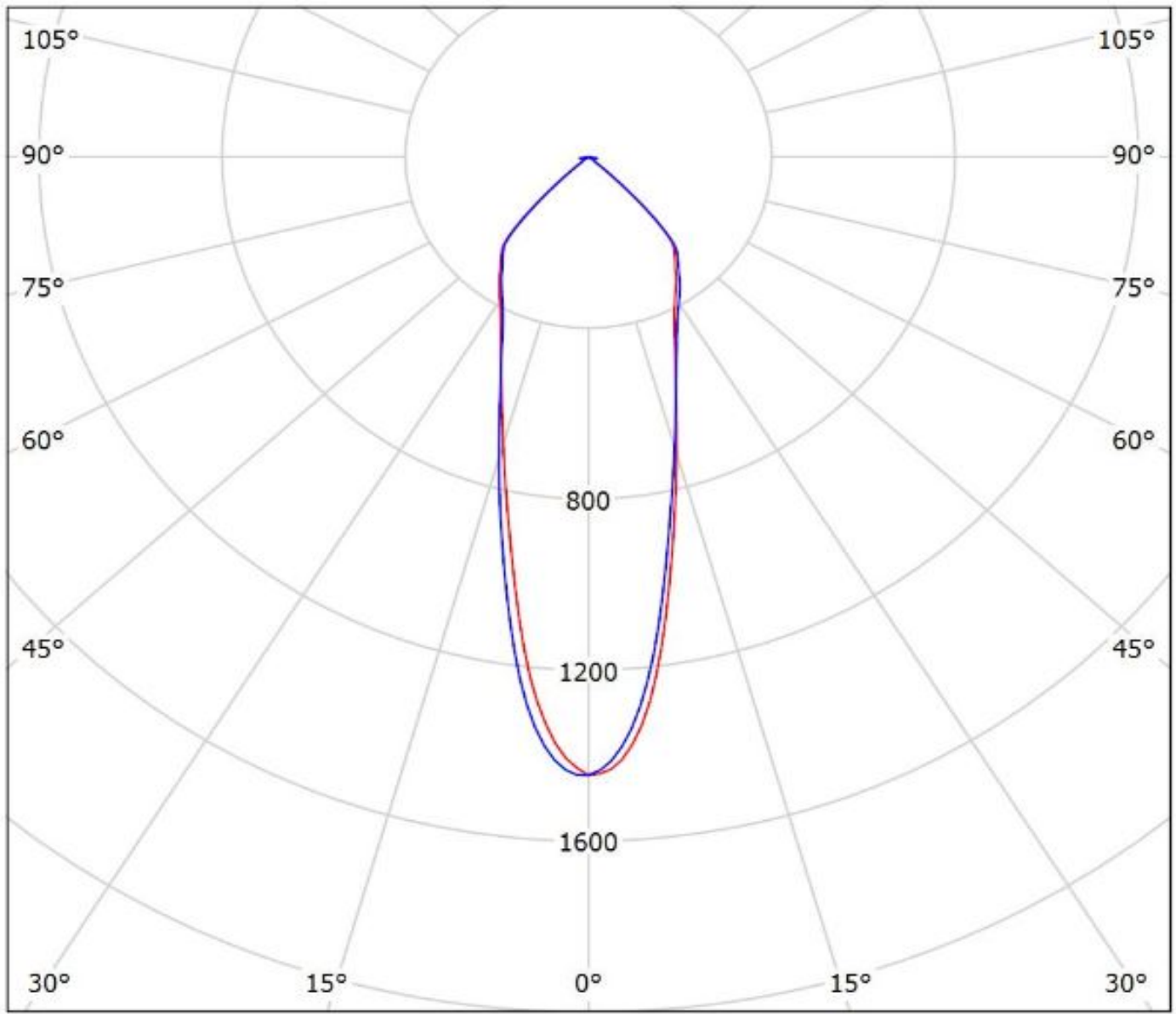

cd/klm

— C0 - C180 — C90 - C270

$\eta = 91\%$

Luminaire: LEDiL Oy F13401_ANGELINA-M_(CXA25) Eff.93.0%
Lamps: 1 x CREE_CXA25_(CXA2530-7C0-T2-N0H)_1151.98lm@250mA_CCT=3000K_P=8.4892W_I=249.8mA

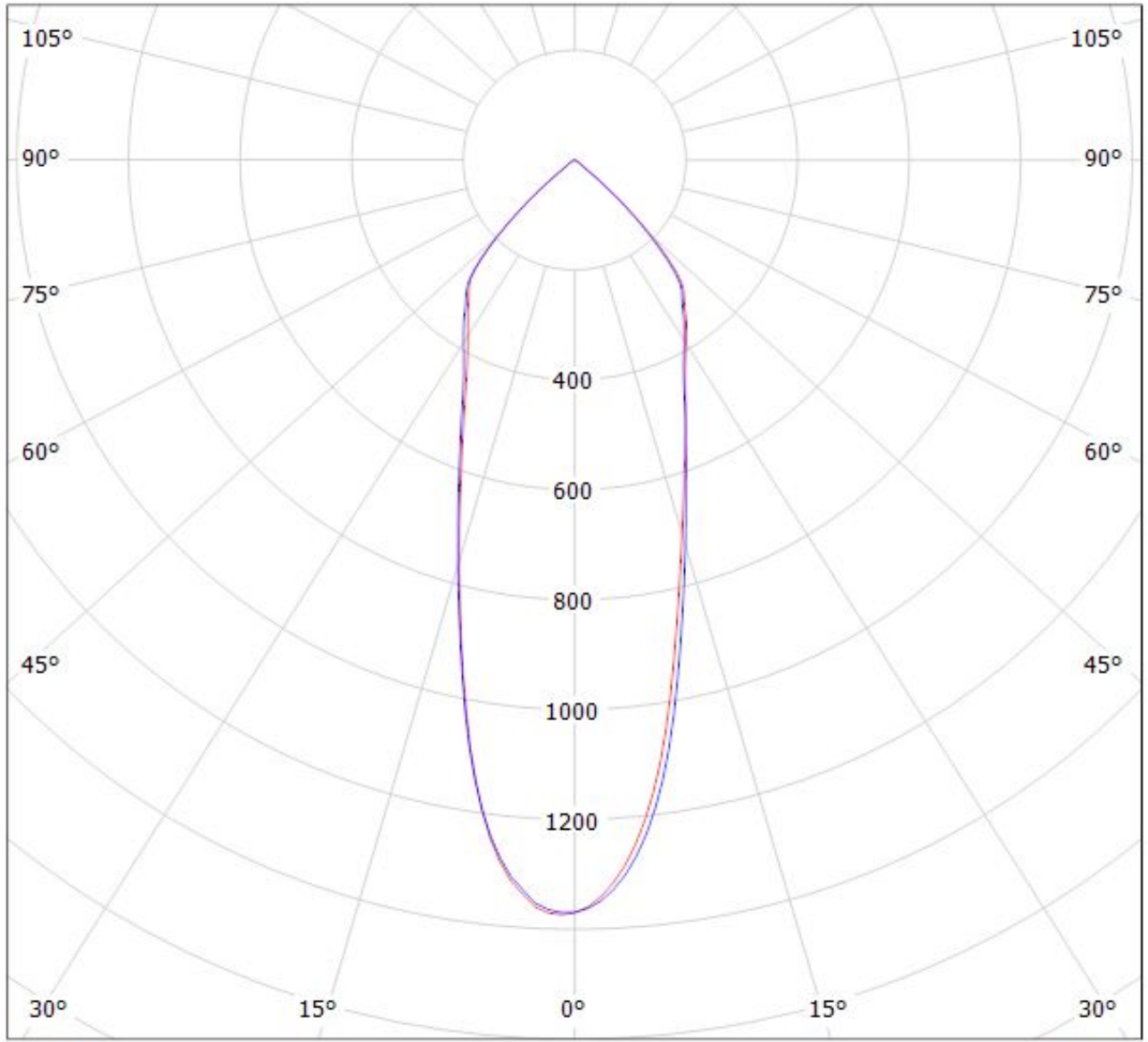

cd/klm

$\eta = 93\%$

— C0 - C180 — C90 - C270

Luminaire: LEDiL Oy F13401_ANGELINA-M_(CXA30) Eff. 93%

Lamps: 1 x CREE_CXA30_(CXA3050-3C0-Y2-N0H)_1340.66lm@250mA_P=8.16471W_CCT=5000K_I=249.8mA

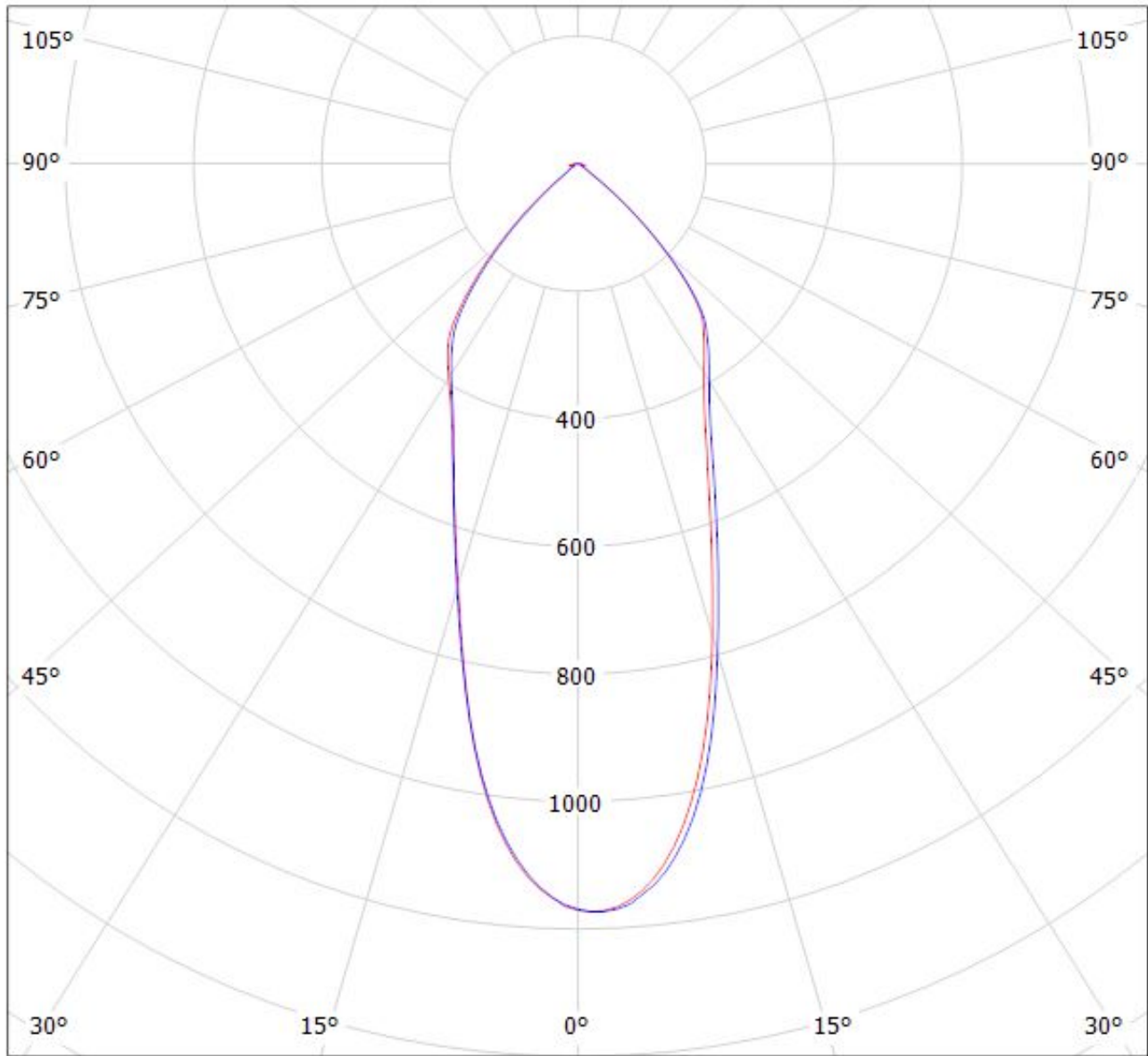

cd/klm

— C0 - C180

— C90 - C270

$\eta = 93\%$

Luminaire: LEDiL Oy F13401_ANGELINA-M_(CXA1816) Eff. 93%
Lamps: 1 x CREE_CXA1816_1042.78lm@250mA_P=8.65157W_I=249.9mA

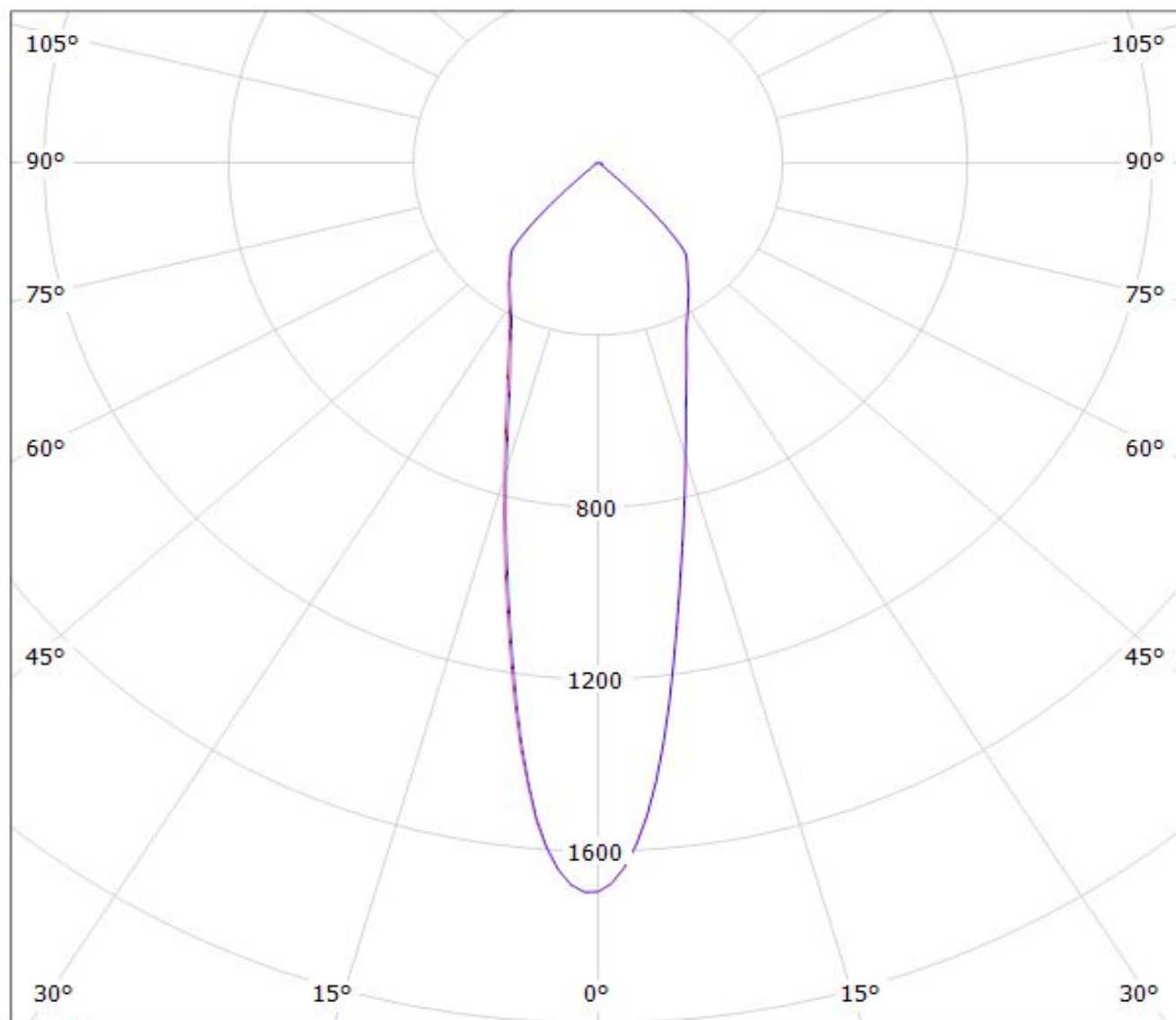

cd/klm

$\eta = 93\%$

— C0 - C180 — C90 - C270

Luminaire: LEDiL Oy F13401_ANGELINA-M_(CXA3590)

Lamps: 1 x CREE_CXA3590_(CXA3590-30F-BD-R0H-0002)_2640.14lm@250mA_CCT=3000K_P=16.3941W_I=249.8mA

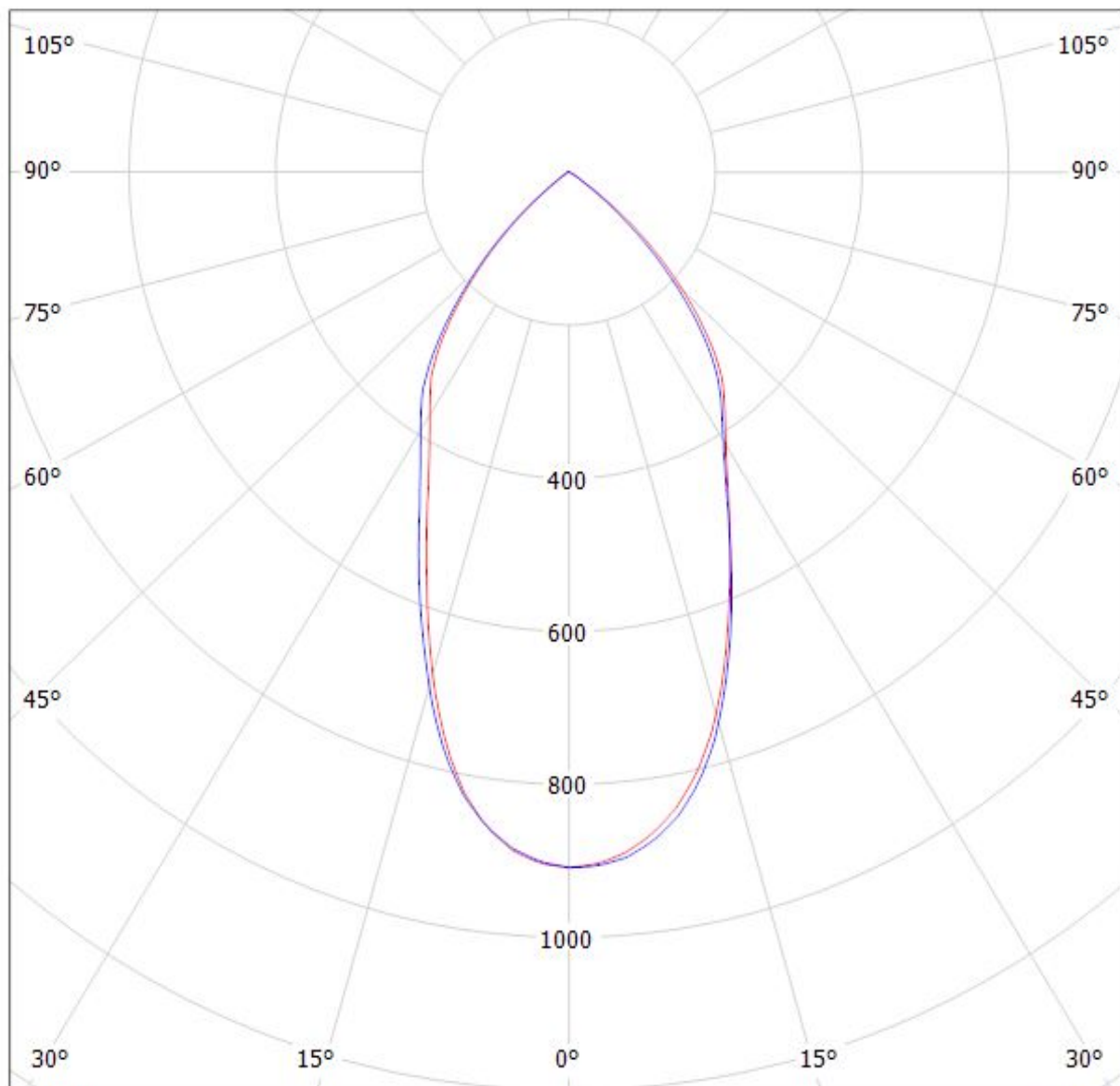

cd/klm

— C0 - C180 — C90 - C270

$\eta = 92\%$

Luminaire: LEDiL Oy F13401_ANGELINA-M_(LG_COB-10W) Eff.92.4%
Lamps: 1 x LG_COB-10W_1024lm@250mA_CCT=5090K_P=9W_I=250mA

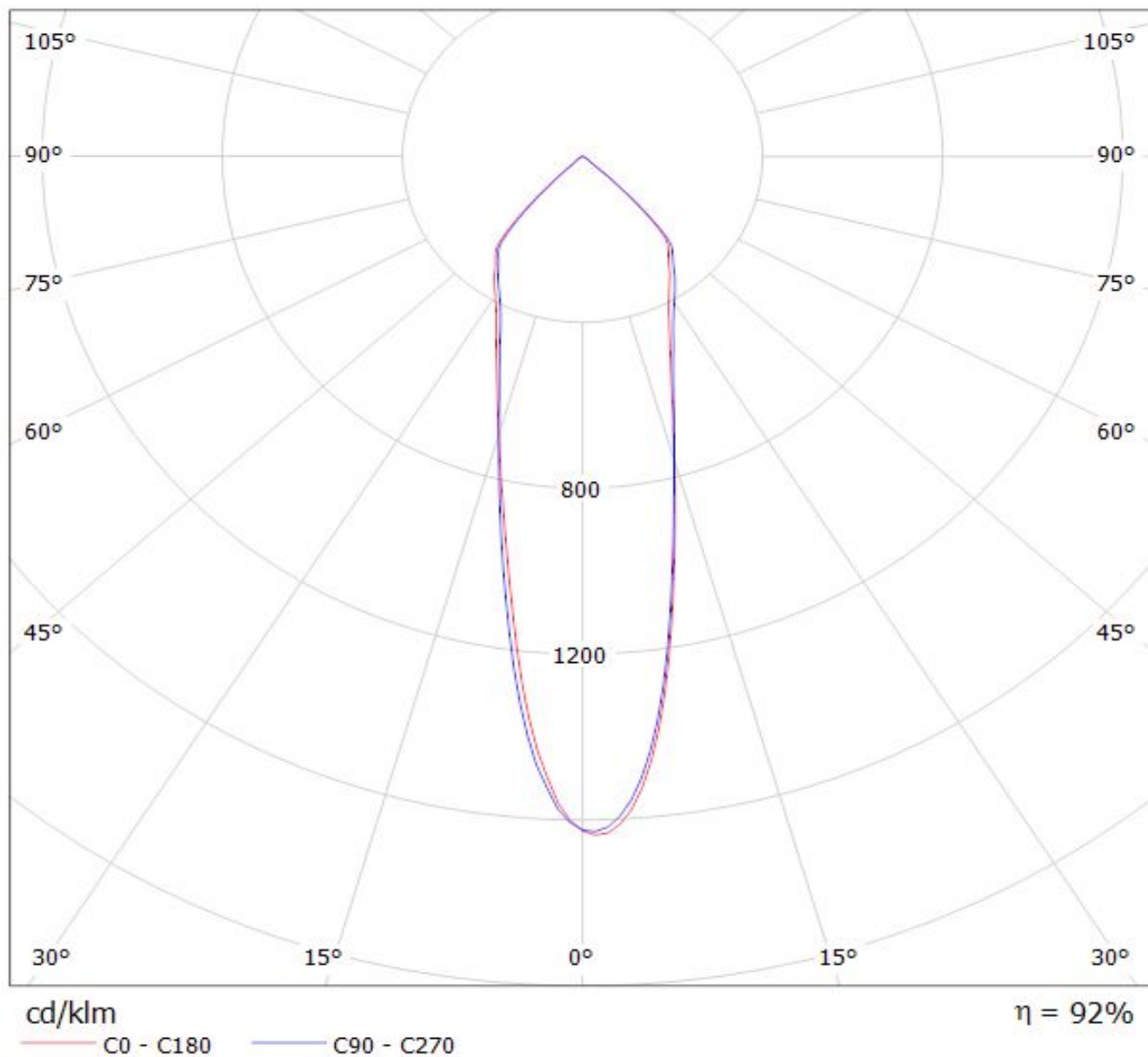

LEDiL Oy C13401_ANGELINA-M_(LUXEON_K16) Eff.93.6% / LDC (Polar)

Luminaire: LEDiL Oy C13401_ANGELINA-M_(LUXEON_K16) Eff.93.6%

Lamps: 1 x LUXEON_K16 (1204.33lm@250mA)

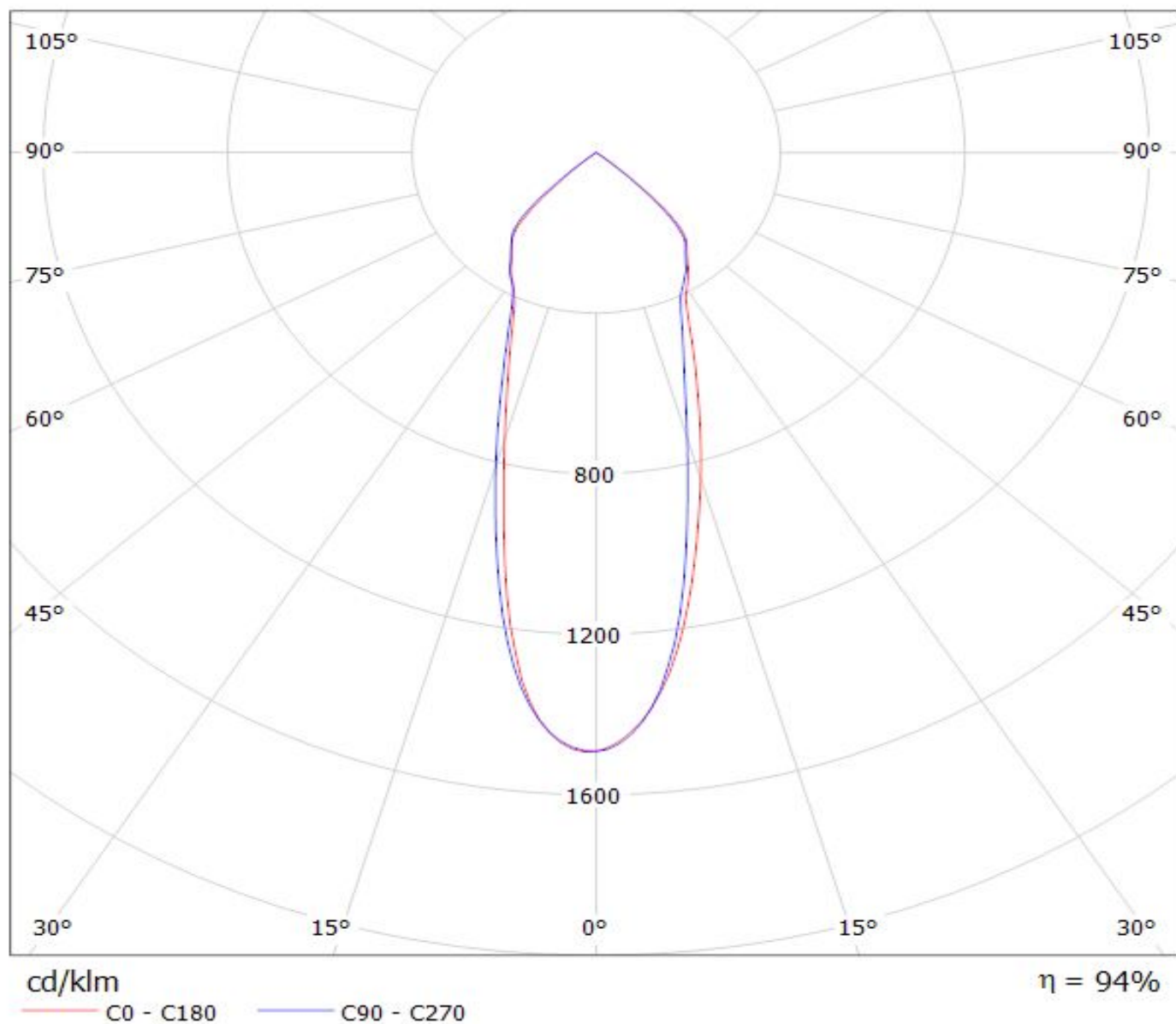

LEDiL Oy C13401_ANGELINA-M_(LUXEON_K12) Eff.94.0% / LDC (Polar)

Luminaire: LEDiL Oy C13401_ANGELINA-M_(LUXEON_K12) Eff.94.0%
Lamps: 1 x LUXEON_K12 (929.543lm@250mA)

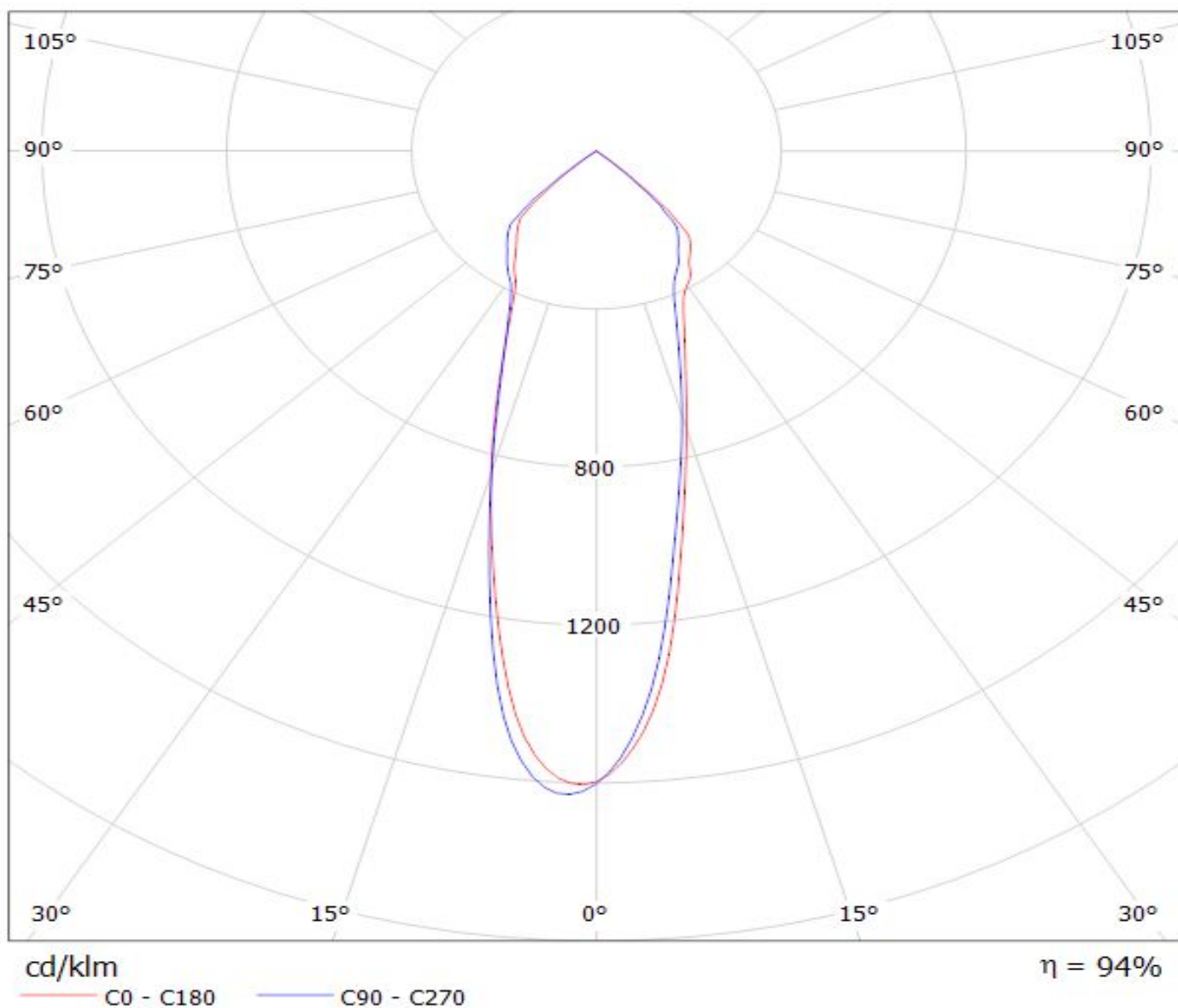

Luminaire: LEDiL Oy F13401_ANGELINA-M_(LUXEON_CoB_1205) Eff: 94 %

Lamps: 1 x LUXEON CoB 1205 (LHC1-3080-1205) 1082lm@250mA CCT=3000K P=8.3W I=250mA

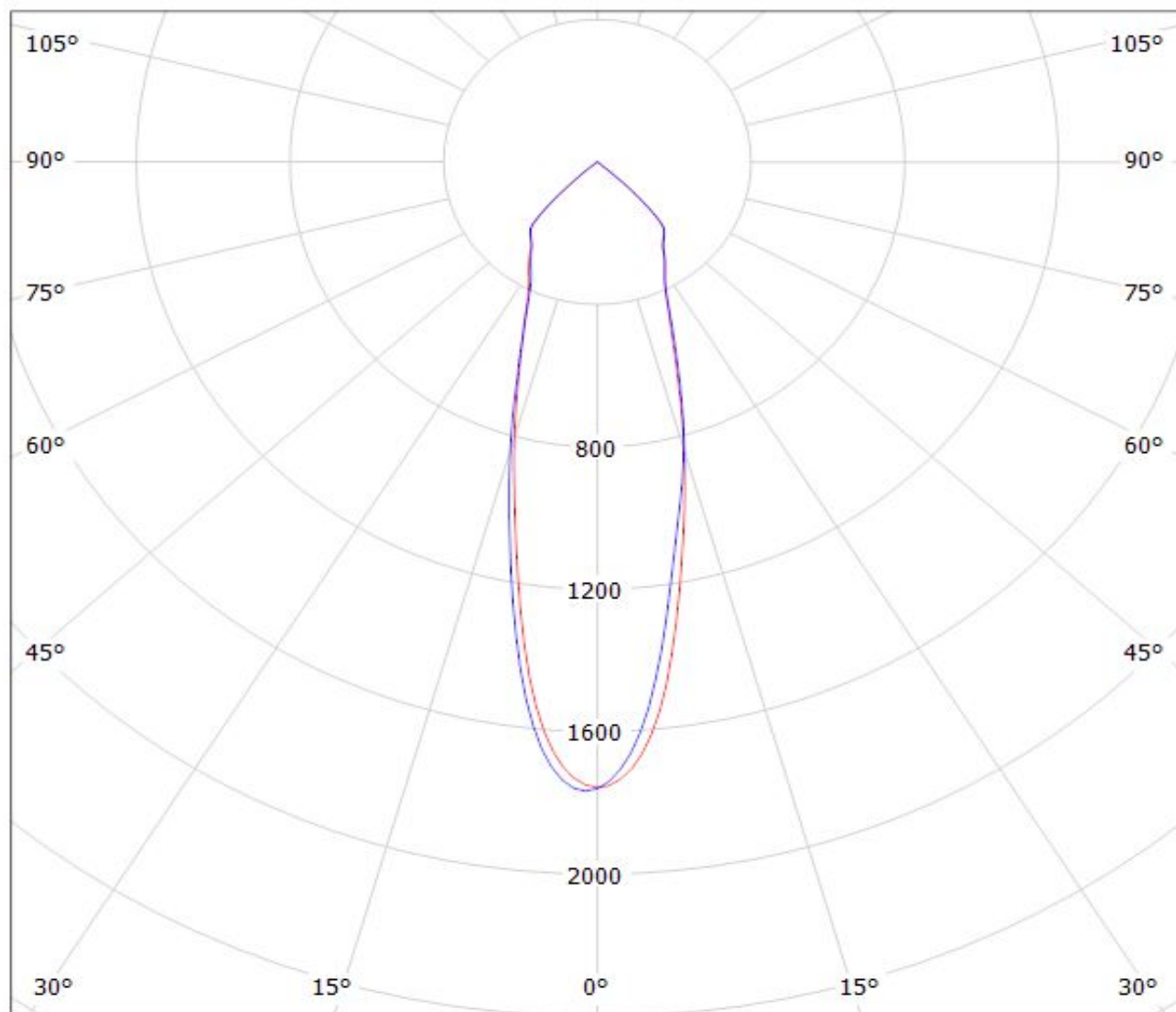

cd/klm

— C0 - C180

— C90 - C270

$\eta = 93\%$

Luminaire: LEDiL Oy F13401_ANGELINA-M (LUXEON_CoB_1208) Eff: 93 %
Lamps: 1 x Luxeon CoB 1208 (LHC1-3080-1208) 1029lm@250mA CCT=3000K P=8.2W I=250mA

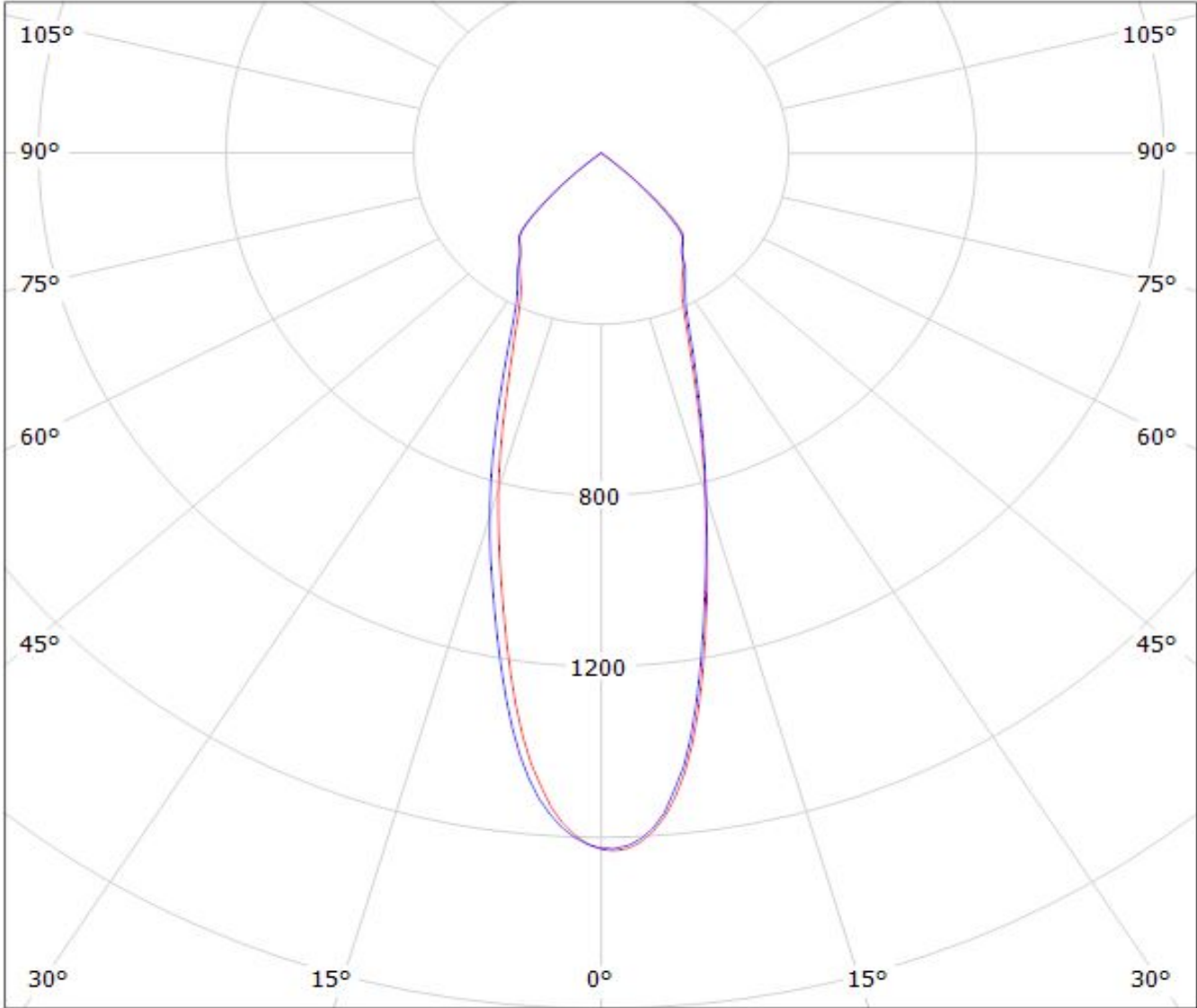

cd/klm

— C0 - C180 — C90 - C270

$\eta = 93\%$

Luminaire: LEDiL Oy F13401_ANGELINA-M_(LUXEON_COB_1205) Eff.92.4%

Lamps: 1 x LUXEON_COB_1205_(LHC1-3080-1205)_1084.49lm@250mA_CCT=3000K_P=8.31784W_I=249.8mA

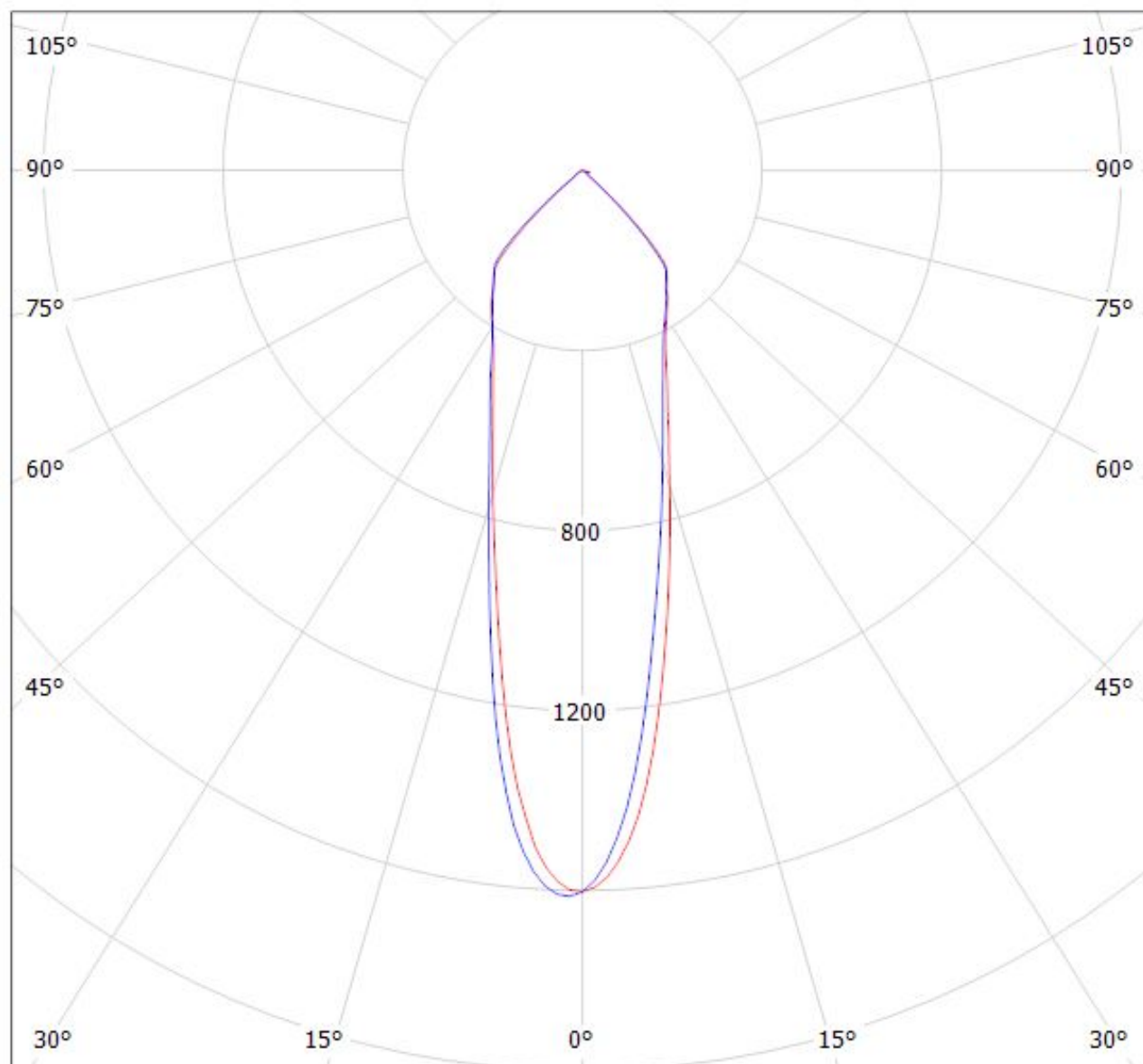

cd/klm

$\eta = 92\%$

— C0 - C180

— C90 - C270

Luminaire: LEDiL Oy F13401_ANGELINA-M_(LUXEON_COB_1208) Eff.92.5%

Lamps: 1 x LUXEON_COB_1208_(LHC1-3080-1208)_1015.13lm@250mA_CCT=3000K_P=8.15972W_I=249.8mA

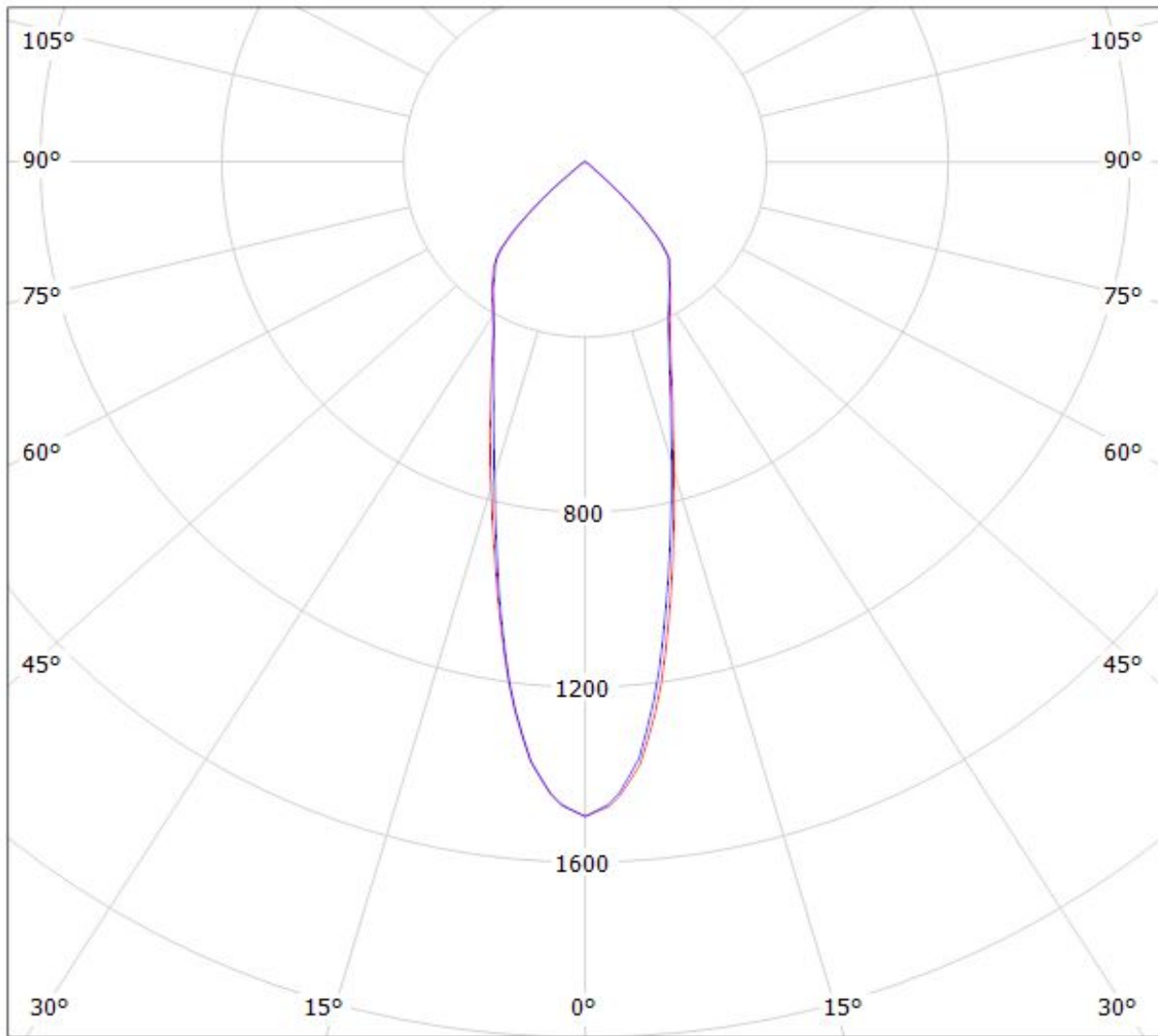

cd/klm

— C0 - C180 — C90 - C270

$\eta = 93\%$

Luminaire: Ledil F13401_ANGELINA-M_(CoB1211+IDEAL)
Lamps: 1 x Luxeon_CoB1211_(L2C2-4080)_50-2204CT+50-2100AN_1376.18lm@250mA_P=7.9988W_I=0.25A

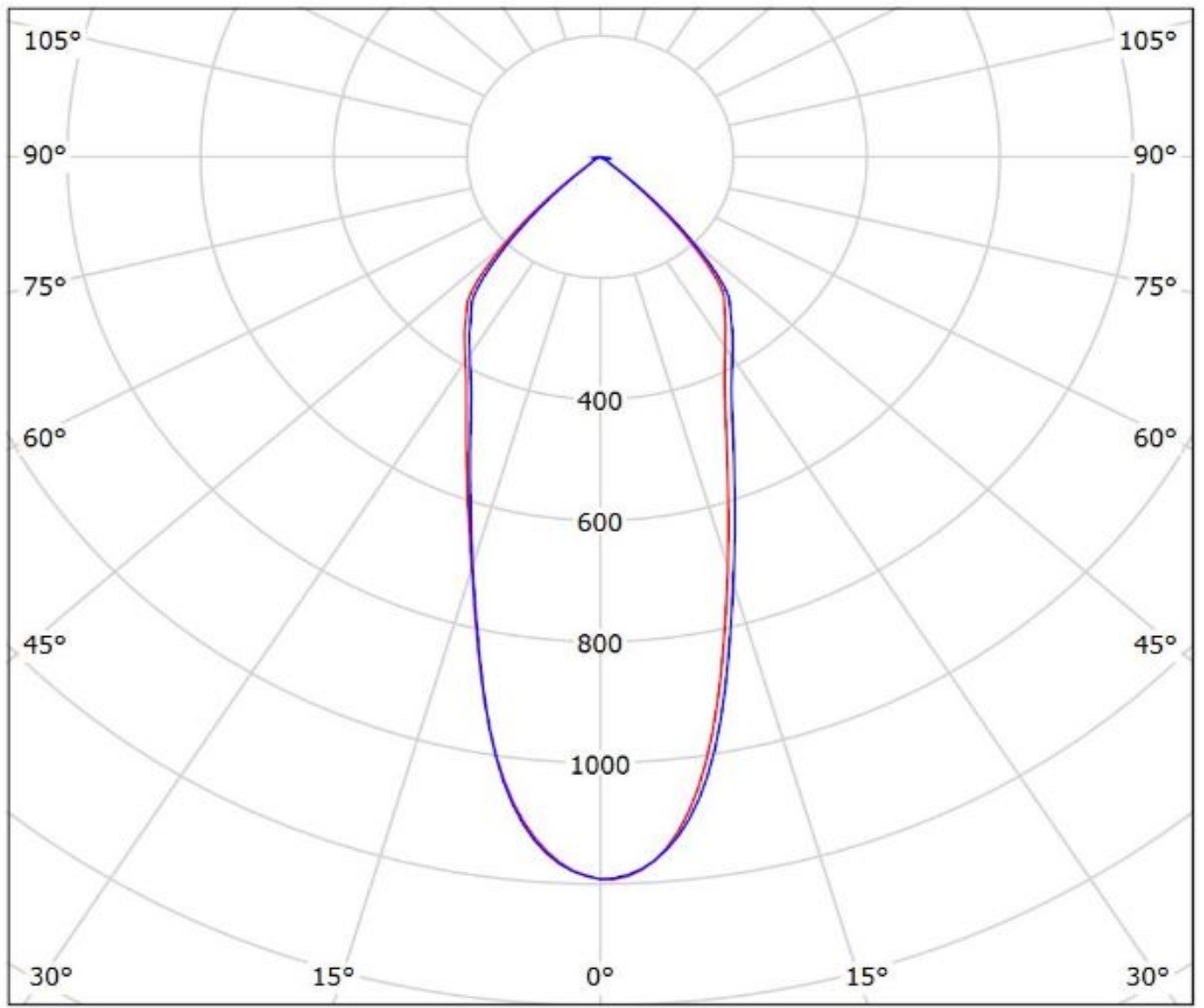

cd/klm

— C0 - C180 — C90 - C270

$\eta = 91\%$

Luminaire: LEDiL Oy F13401_ANGELINA-M_(CXM-14)

Lamps: 1 x LUMINUS_CXM-14_1114.36lm@250mA_P=8.36106W_I=249.8mA

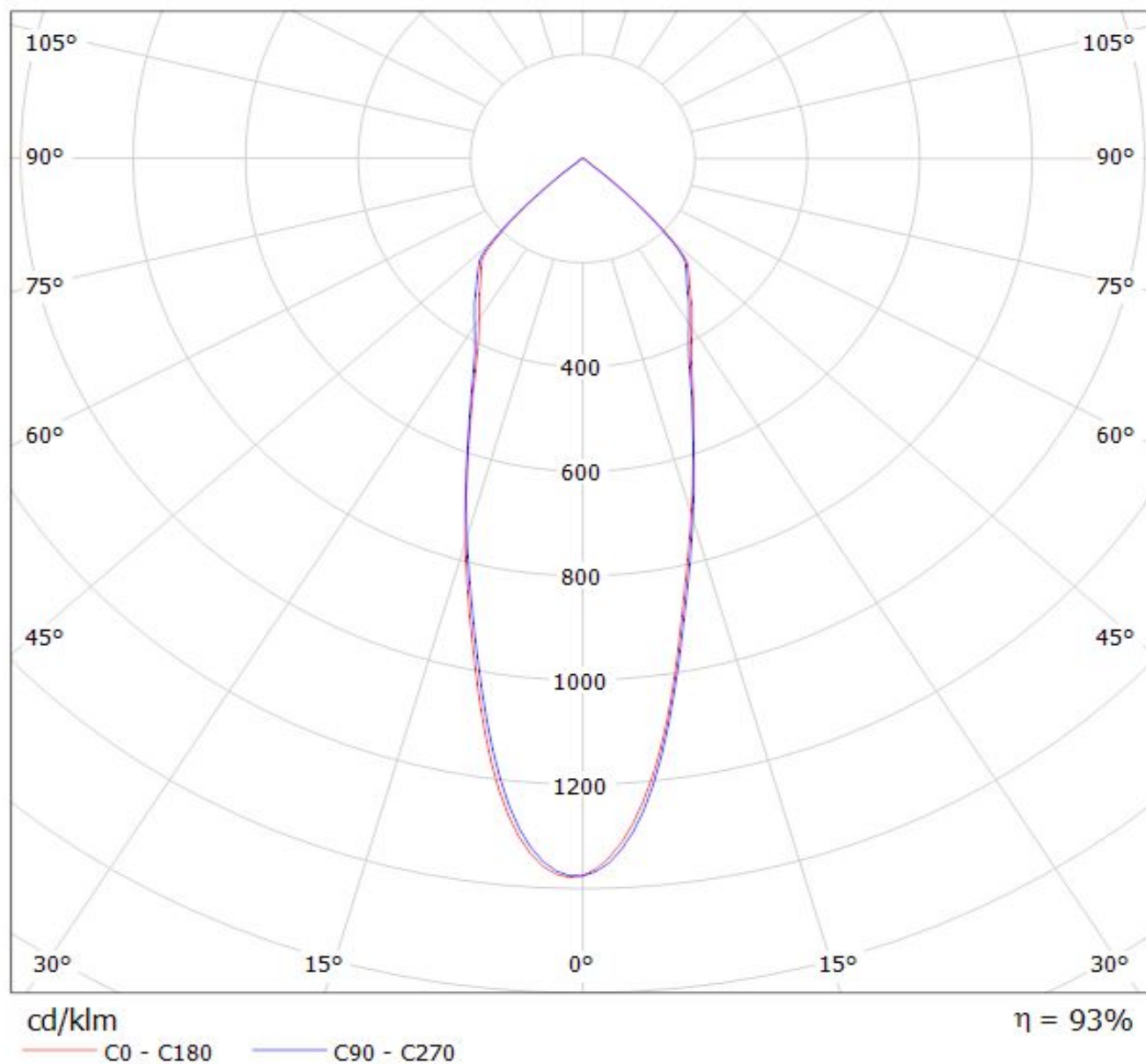

Luminaire: LEDiL Oy F13401_ANGELINA-M_(NSCxJ216A) Eff.93.5%
Lamps: 1 x NICHIA_NSCxJ216A_(NSCLJ216AE)_949.847lm@250mA_CCT=3000K_P=7.96937W_I=249.8mA

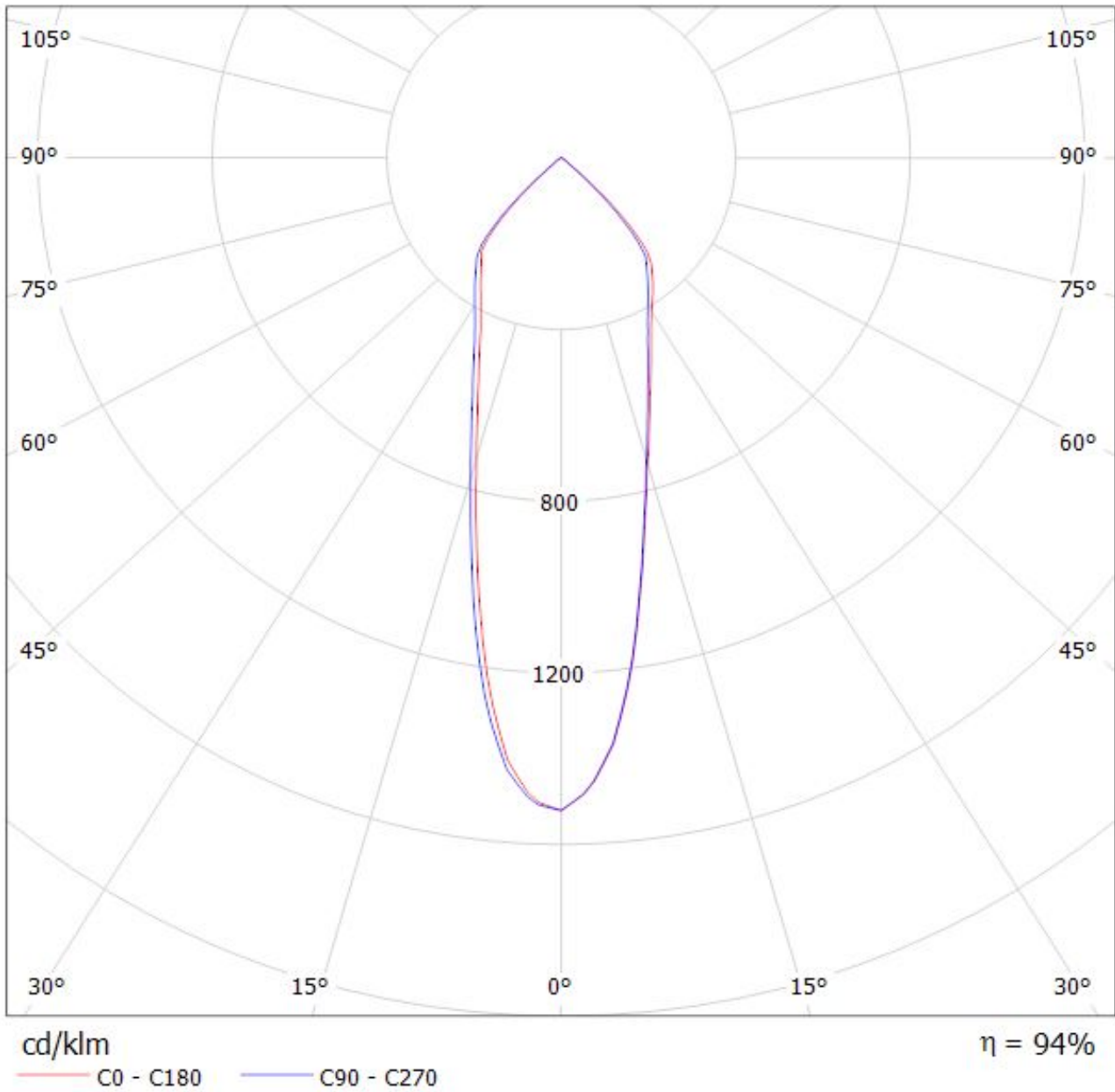

Luminaire: LEDiL Oy F13401_ANGELINA-M_(NSBxL121A) Eff.90.8%

Lamps: 1 x NICHIA_NSBxL121A_(NSBLL121AE)_805.561lm@250mA_CCT=3000K_P=7.3681W_I=249.8mA

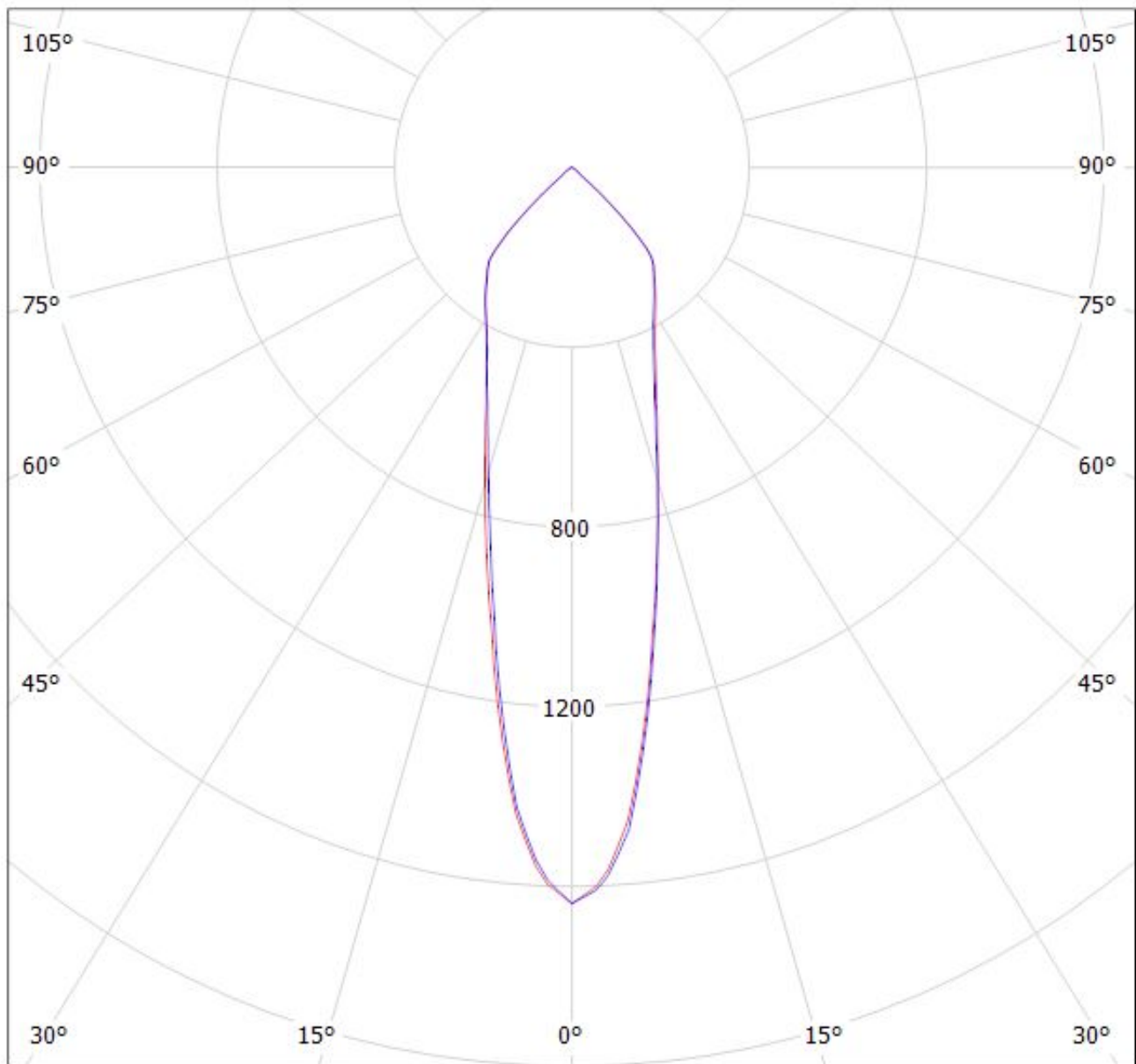

cd/klm

— C0 - C180

— C90 - C270

$\eta = 91\%$

Luminaire: LEDiL Oy F13401_ANGELINA-M_(NSBxL121A)

Lamps: 1 x Nichia_NSBxL121A_914.478lm@250mA_P=7.56872W_I=249.9mA

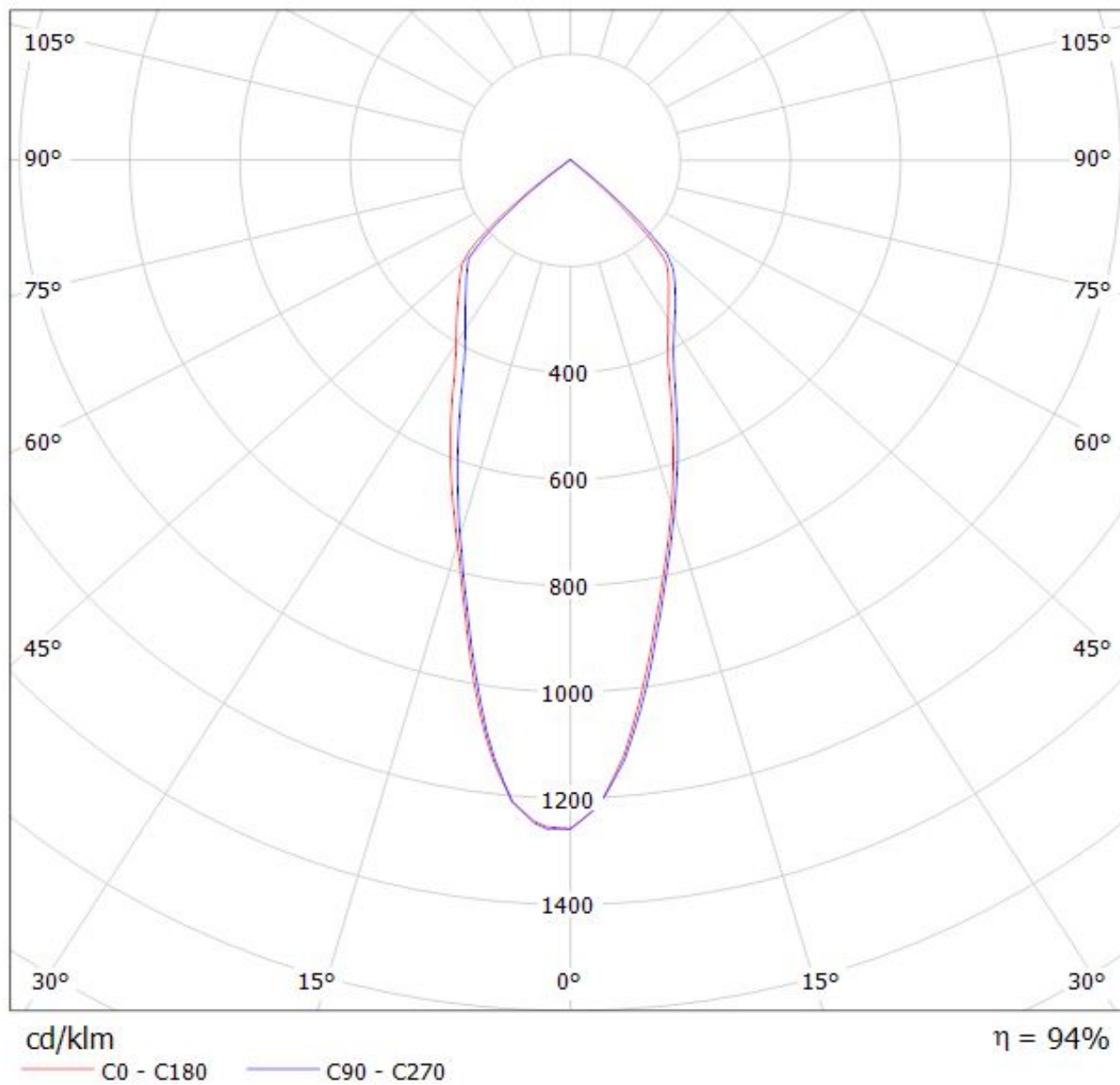

Luminaire: Ledil F13401_ANGELINA-M_(NVCLL024Z+TE)

Lamps: 1 x Nichia_NVCLL024Z_+2213382-2_+2213194-1_971.485lm@250mA_CCT=3000K_P=8W_I=0.25A

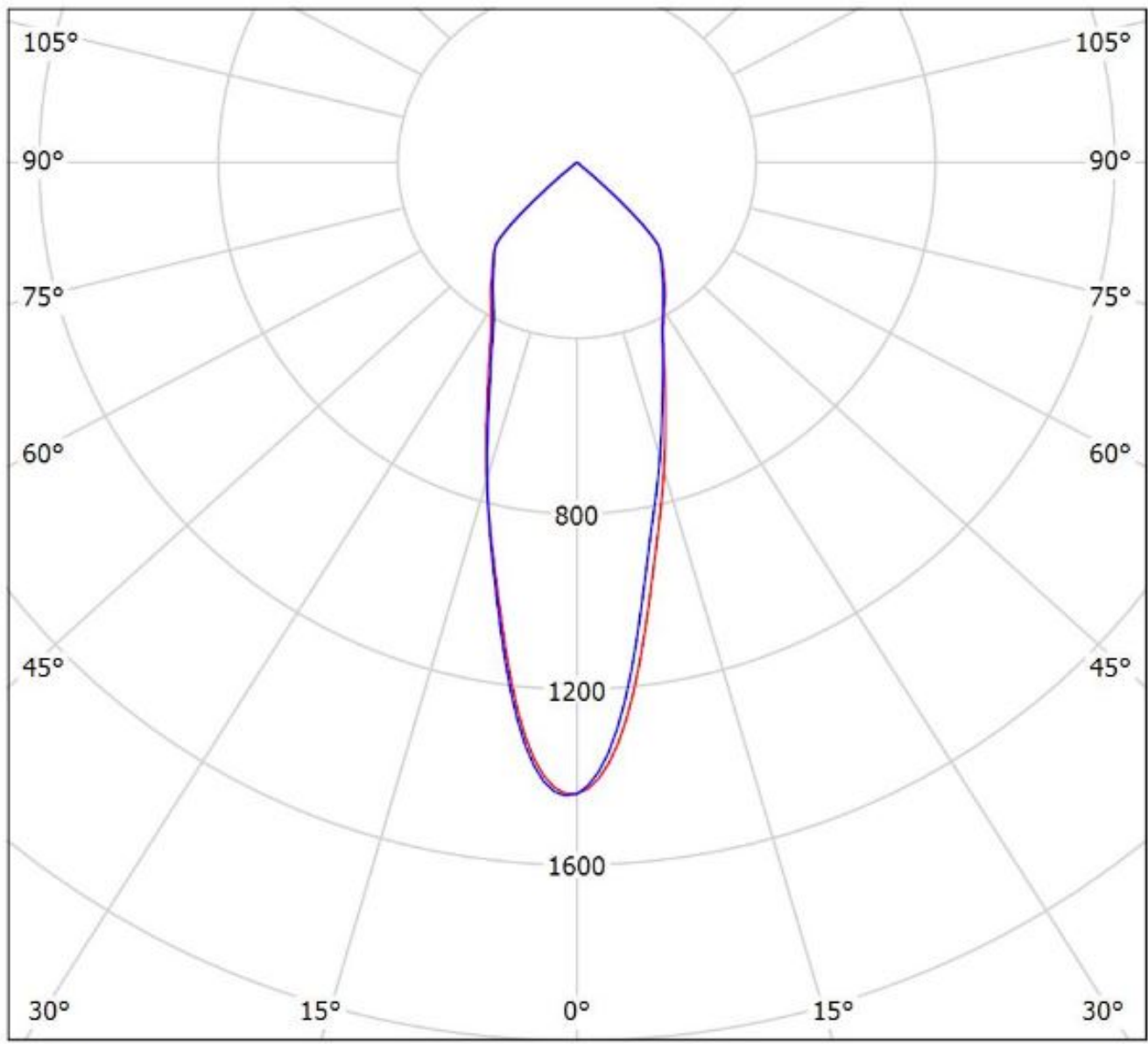

cd/klm

— C0 - C180 — C90 - C270

$\eta = 91\%$

Luminaire: LEDiL Oy F13401_ANGELINA-M_(PrevaLED_LES9) Eff.93%

Lamps: 1 x OSRAM PrevaLED_LES9_(PL-CORE-1100-830-Z3)_507.9lm@100mA_P=4.5039W_I=100.1mA

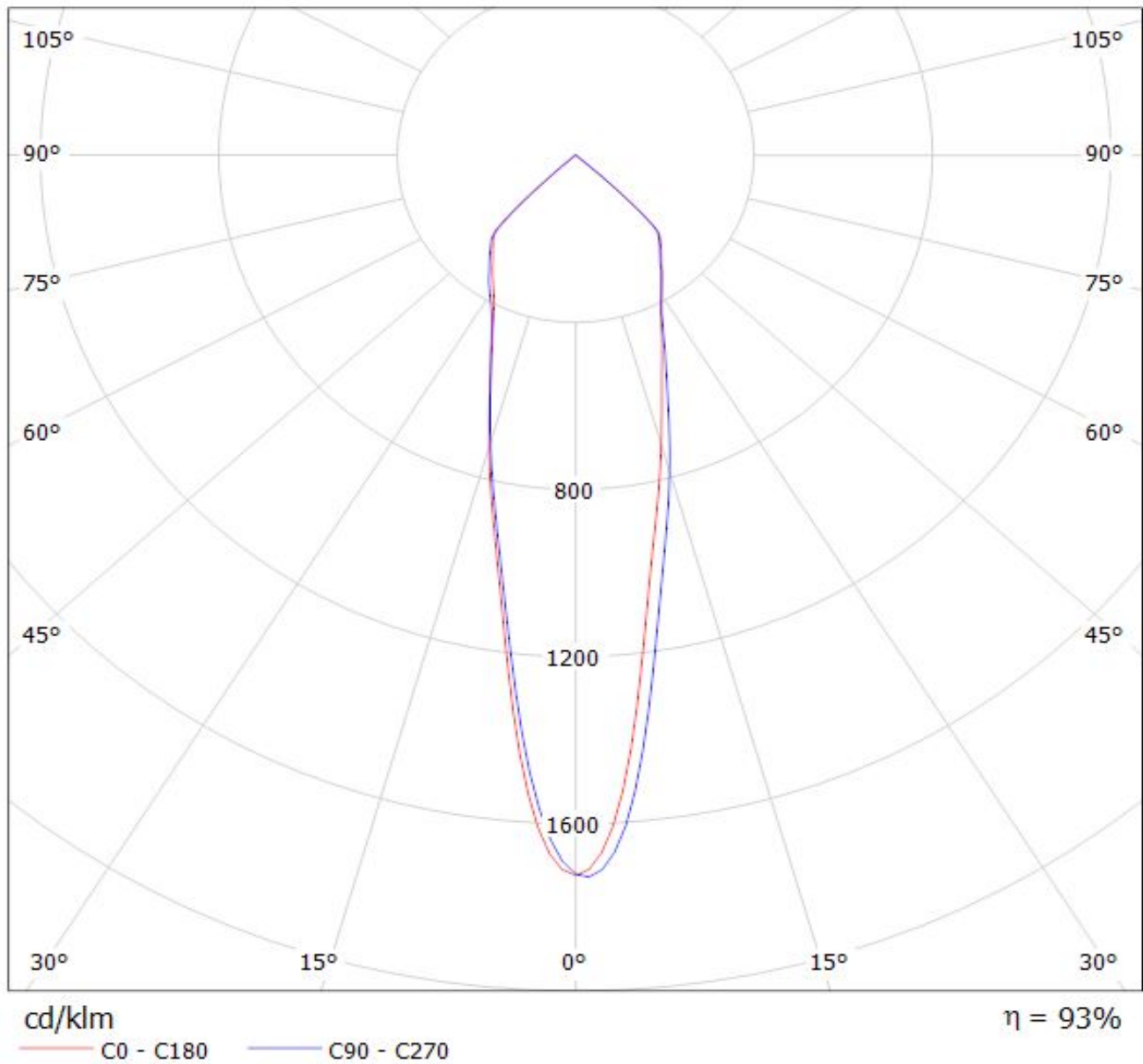

Luminaire: LEDiL Oy F13401_ANGELINA-M_(PrevaLED_LES23) Eff.94%

Lamps: 1 x OSRAM PrevaLED_LES23_(PL-CORE-5000-930-Z3)_1102.2lm@250mA_P=9.93654W_I=249.8mA

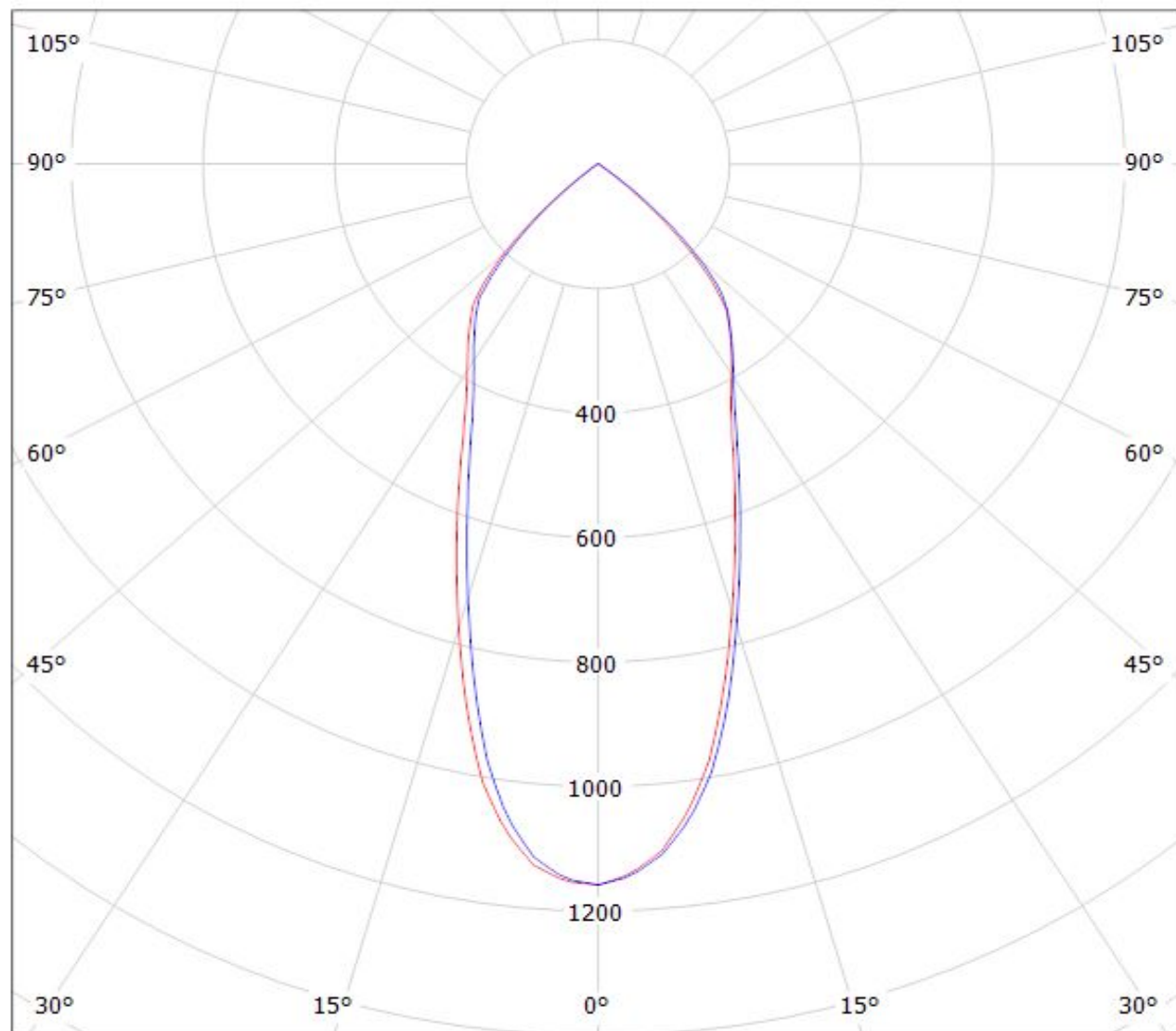

cd/klm

— C0 - C180

— C90 - C270

$\eta = 94\%$

Luminaire: LEDiL Oy F13401_ANGELINA-M_(PrevaLED_LES19) Eff. 93%

Lamps: 1 x PrevaLED_LES19_(PL-CORE-2000-830-Z3)_1333.47lm@250mA_P=10.4584W_I=249.8mA

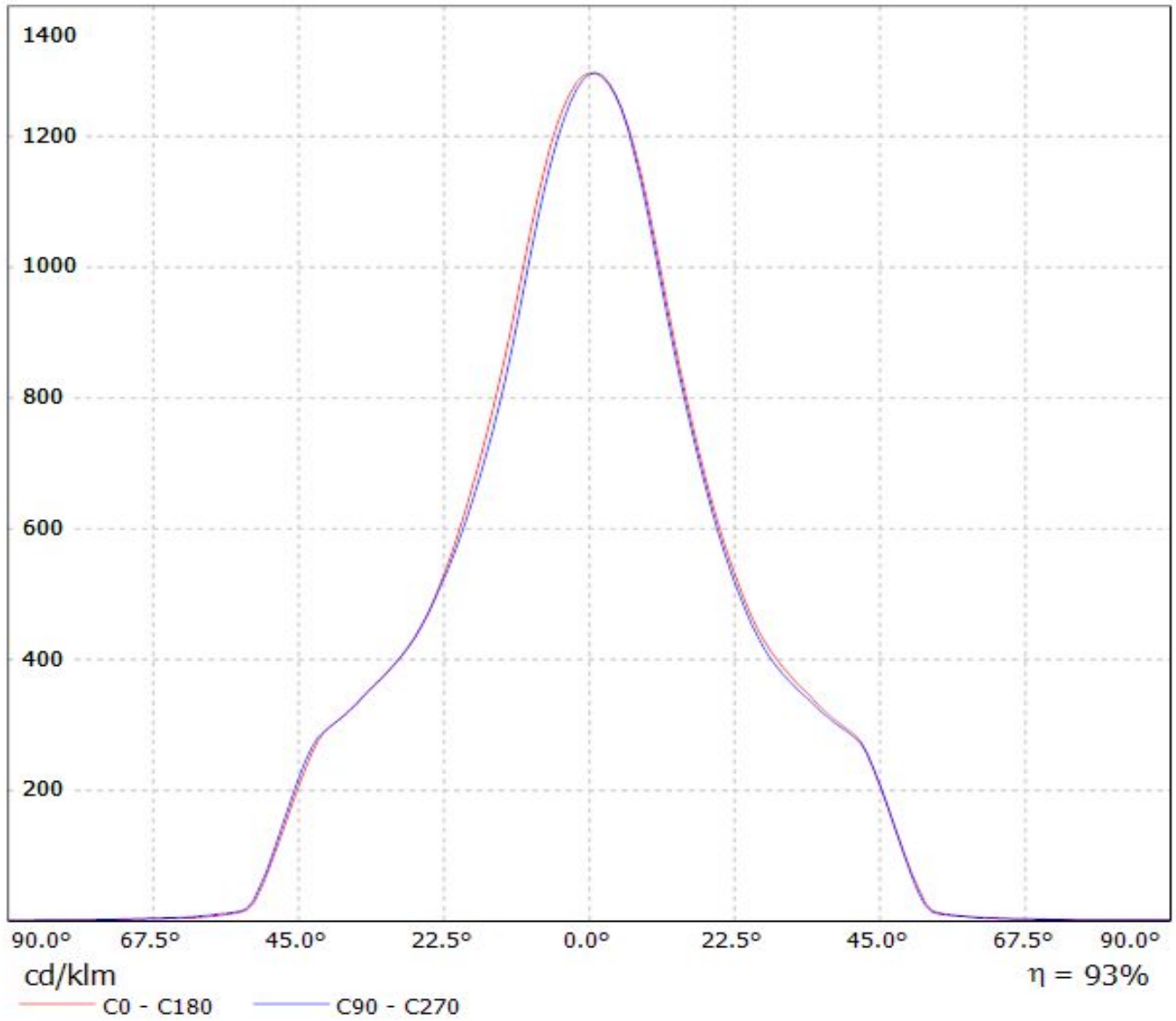

Luminaire: LEDil Oy F13401_ANGELINA-M_(Soleriq_S13) Efficiency=94%

Lamps: 1 x Osram Soleriq S13 (GW KAGHB1.EM) 855lm @ 250mA CCT=3100K P=7.5W I=250mA

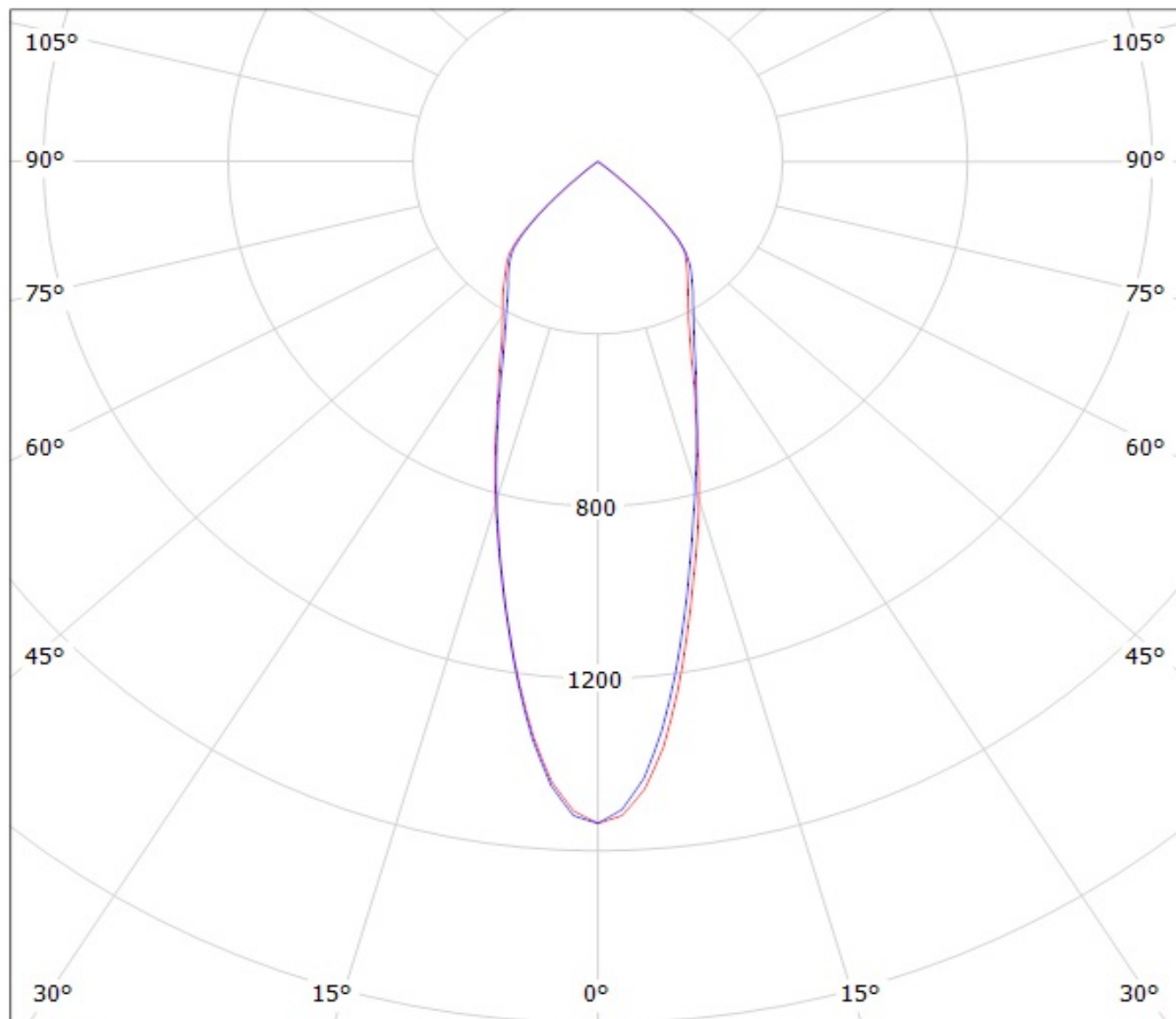

cd/klm

— C0 - C180

— C90 - C270

Luminaire: LEDiL Oy F13401_ANGELINA-M_(SOLERIQ_S19_&_TE_2213407-2)

Lamps: 1 x OSRAM_SOLERIQ_S19_(GW_KAHJB1.EM)_1393.62lm@250mA_CCT=3000K_P=10.5683W_I=249.8mA

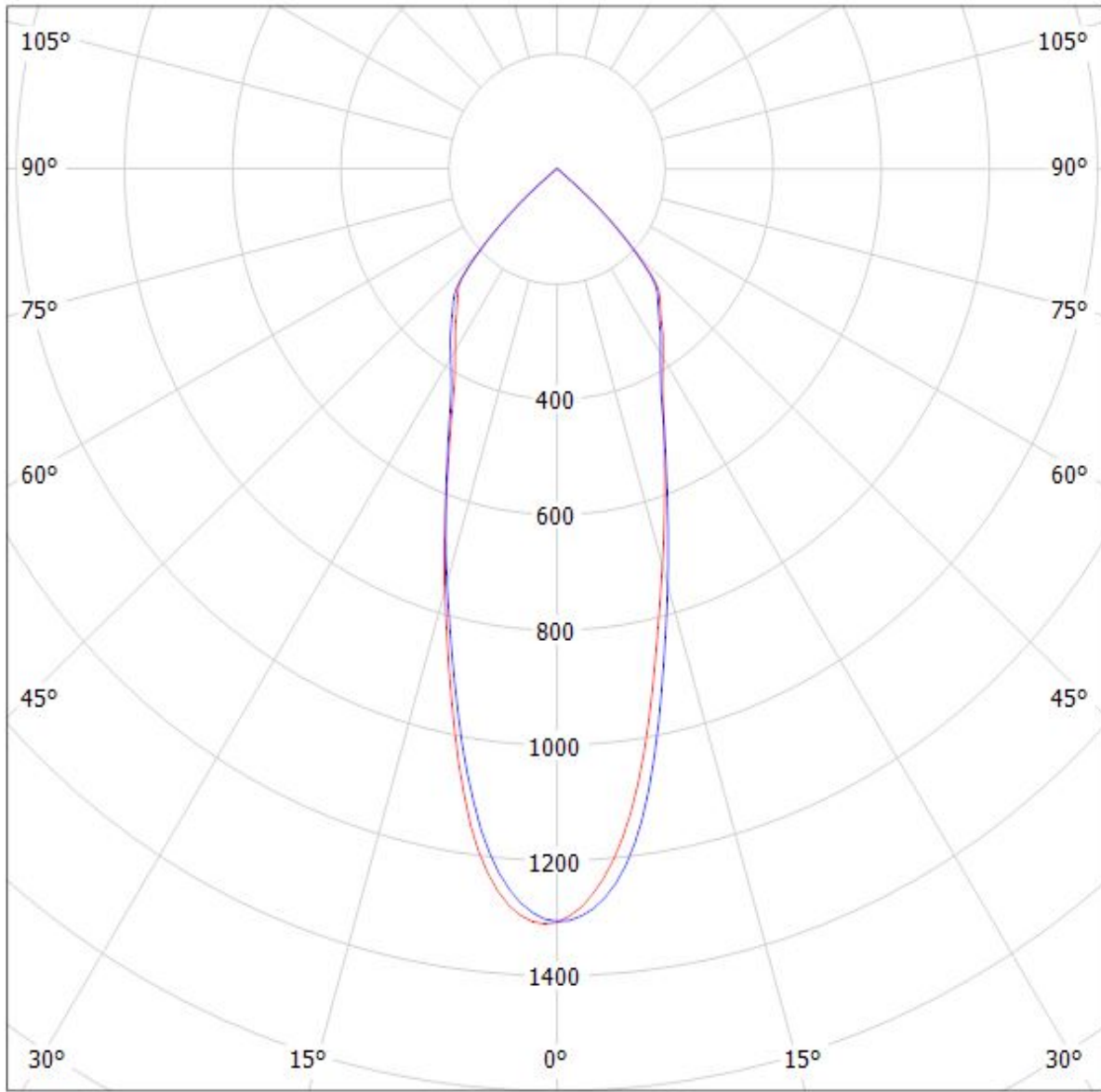

cd/klm

— C0 - C180 — C90 - C270

$\eta = 93\%$

Luminaire: LEDiL Oy F13401_ANGELINA-M_(LEP-800-827-C-AC)

Lamps: 1 x OSRAM PrevaLED Core AC (LEP-800-827-C-AC) 910lm@60mA U:230V P:14W

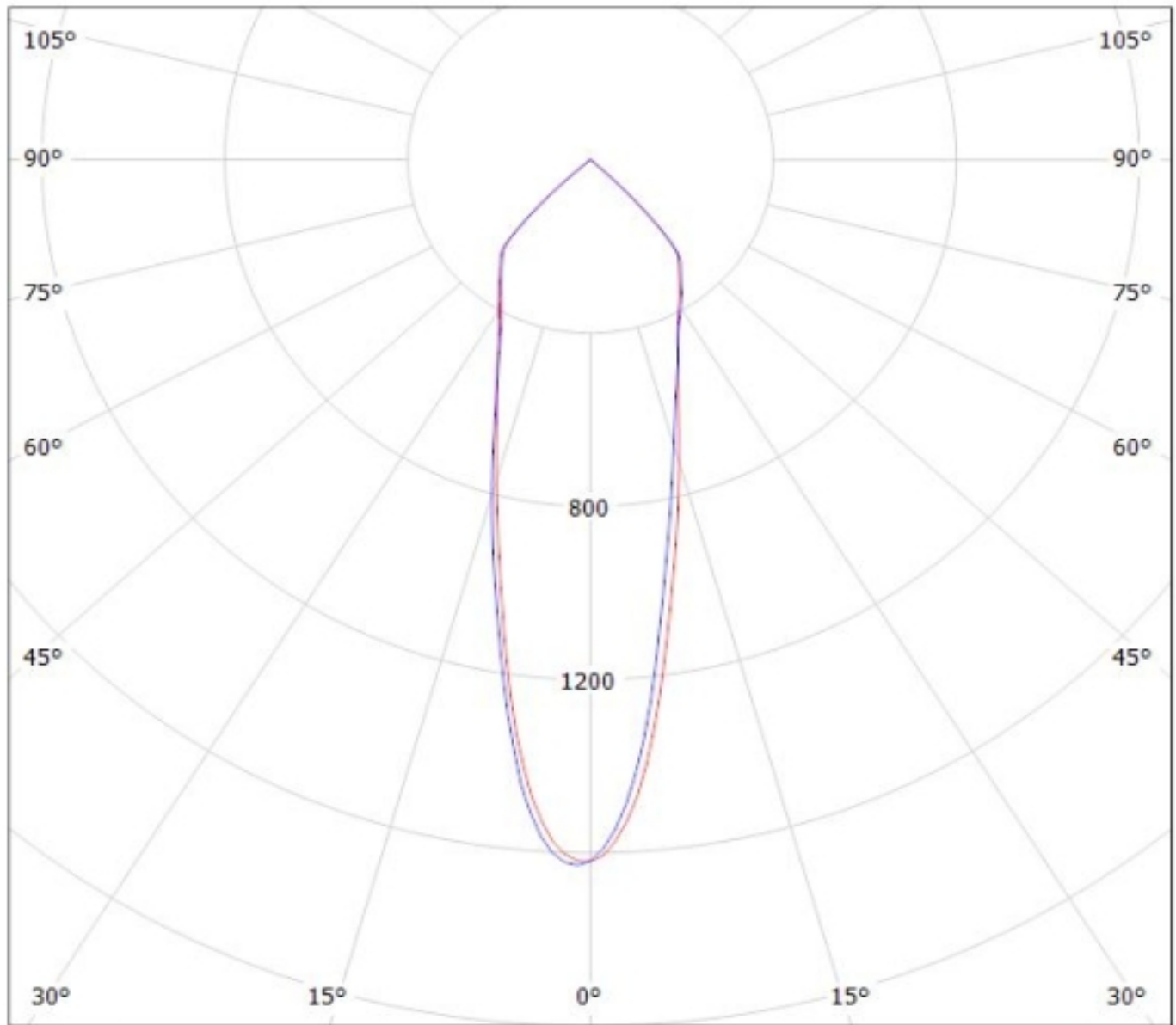

cd/klm

— C0 - C180 — C90 - C270

η = 93%

Luminaire: LEDiL Oy F13401_ANGELINA-M_(LEP-2000-827-C-AC)
Lamps: 1 x OSRAM PrevaLED Core AC (LEP-2000-827-C-AC)

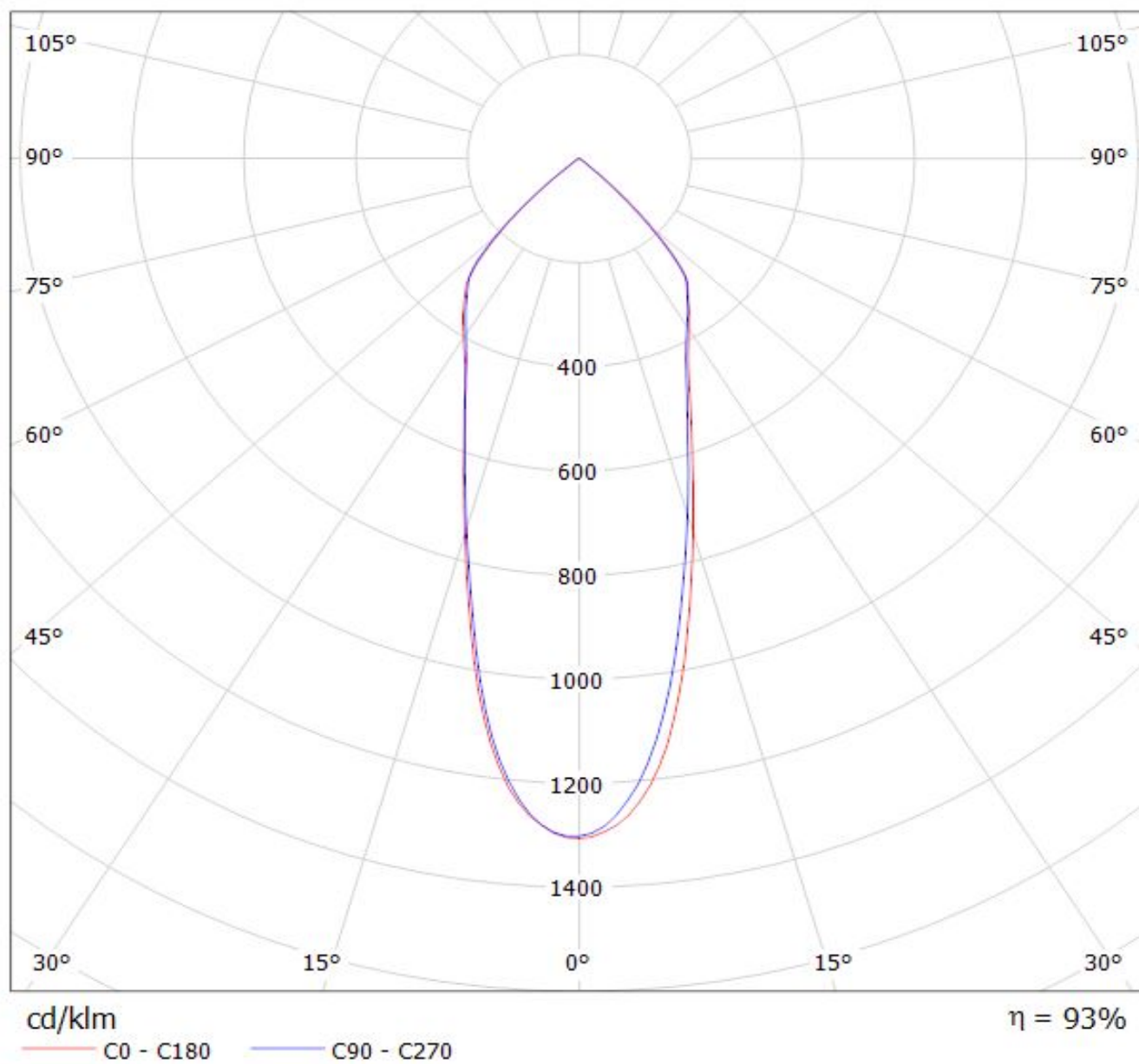

Luminaire: LEDiL Oy F13401_ANGELINA-M_(PrevaLED_Z4) Eff.93%

Lamps: 1 x Osram_PrevaLED_CORE_Z4_(PL-CORE-3000-830-Z4)_1423.93lm@250mA_P=10.7652W_I=249.9mA

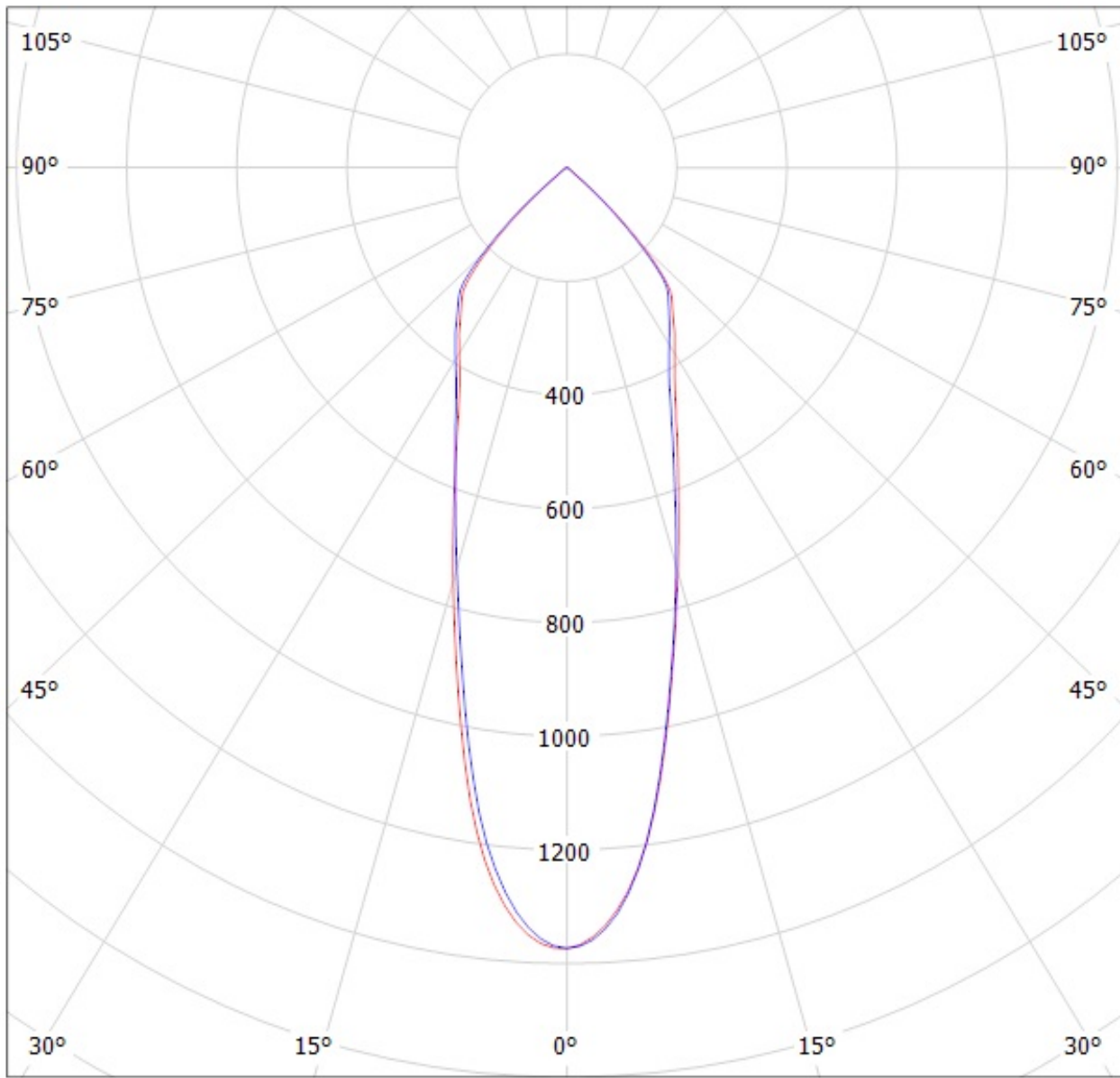

cd/klm

$\eta = 93\%$

— C0 - C180

— C90 - C270

Luminaire: LEDiL Oy F13401_ANGELINA-M_(SOLERIQ_P13)

Lamps: 1 x SOLERIQ_P13_(GW_MAGMB1.EM)_1038.25lm@250mA_CCT=3000K_P=8.77223W_I=249.8mA

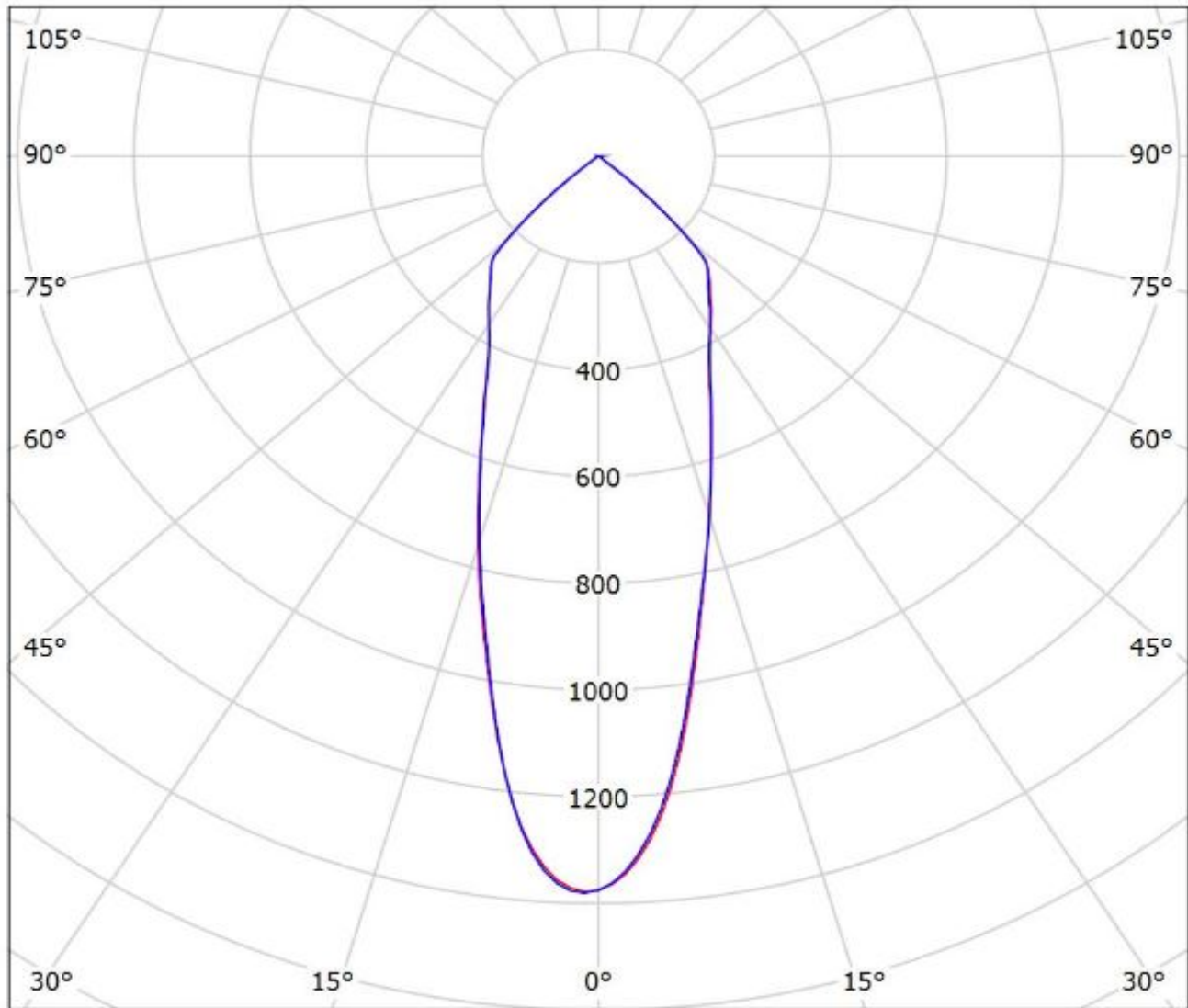

cd/klm

— C0 - C180

— C90 - C270

$\eta = 93\%$

Luminaire: Ledil F13401_ANGELINA-M_(S13_Gen2+IDEAL)

Lamps: 1 x Soleriq_S13_Gen2+_50-2103CT+_50-2100AN_1327.38lm@250mA_P=8.7850W_I=0.250A

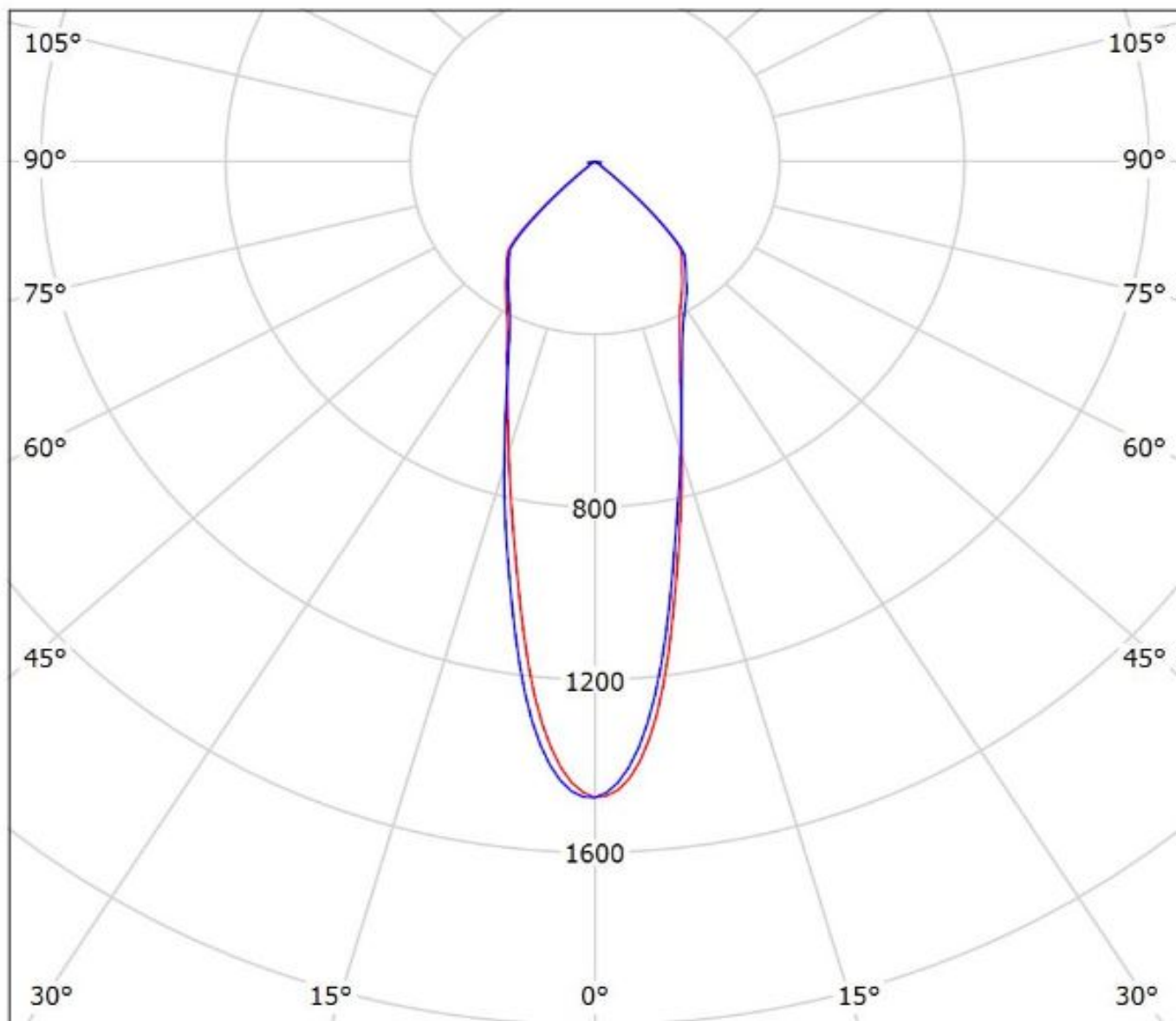

cd/klm

— C0 - C180 — C90 - C270

$\eta = 91\%$

Luminaire: Ledil F13401_ANGELINA-M_(S13_Gen2+TE)

Lamps: 1 x Soleriq_S13_Gen2+_2213254-2+_2213194-1_1309.23lm@250mA_P=8.7840W_I=0.250A

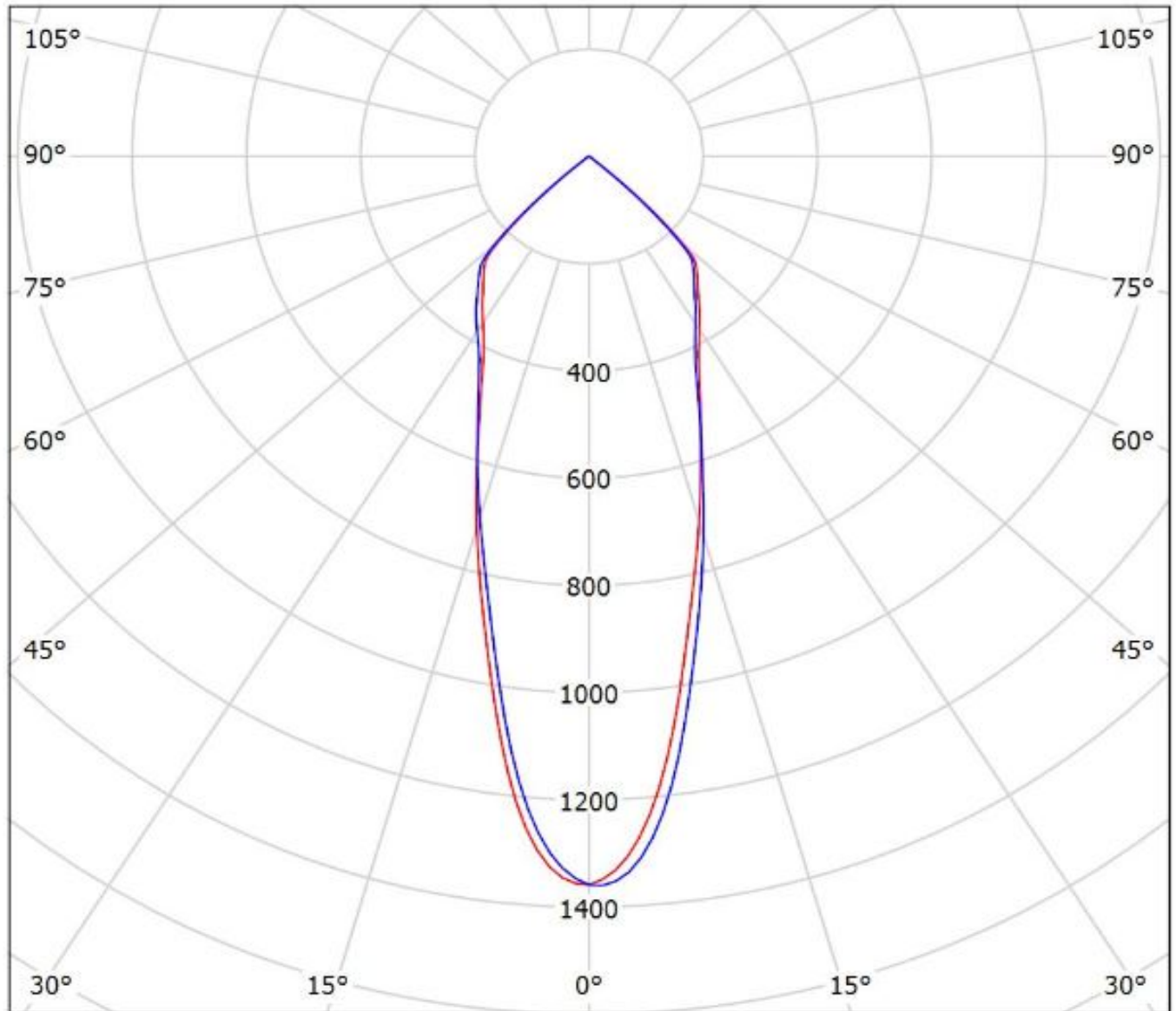

cd/klm

— C0 - C180

— C90 - C270

$\eta = 91\%$

Luminaire: LEDiL Oy F13401_ANGELINA-M_(FORTIMO_2000) Eff.90.5%

Lamps: 1 x PHILIPS Fortimo LED SLM 2000 23W/930 L19 G3 665.774lm@250mA CCT=3000K P=6W I=250mA

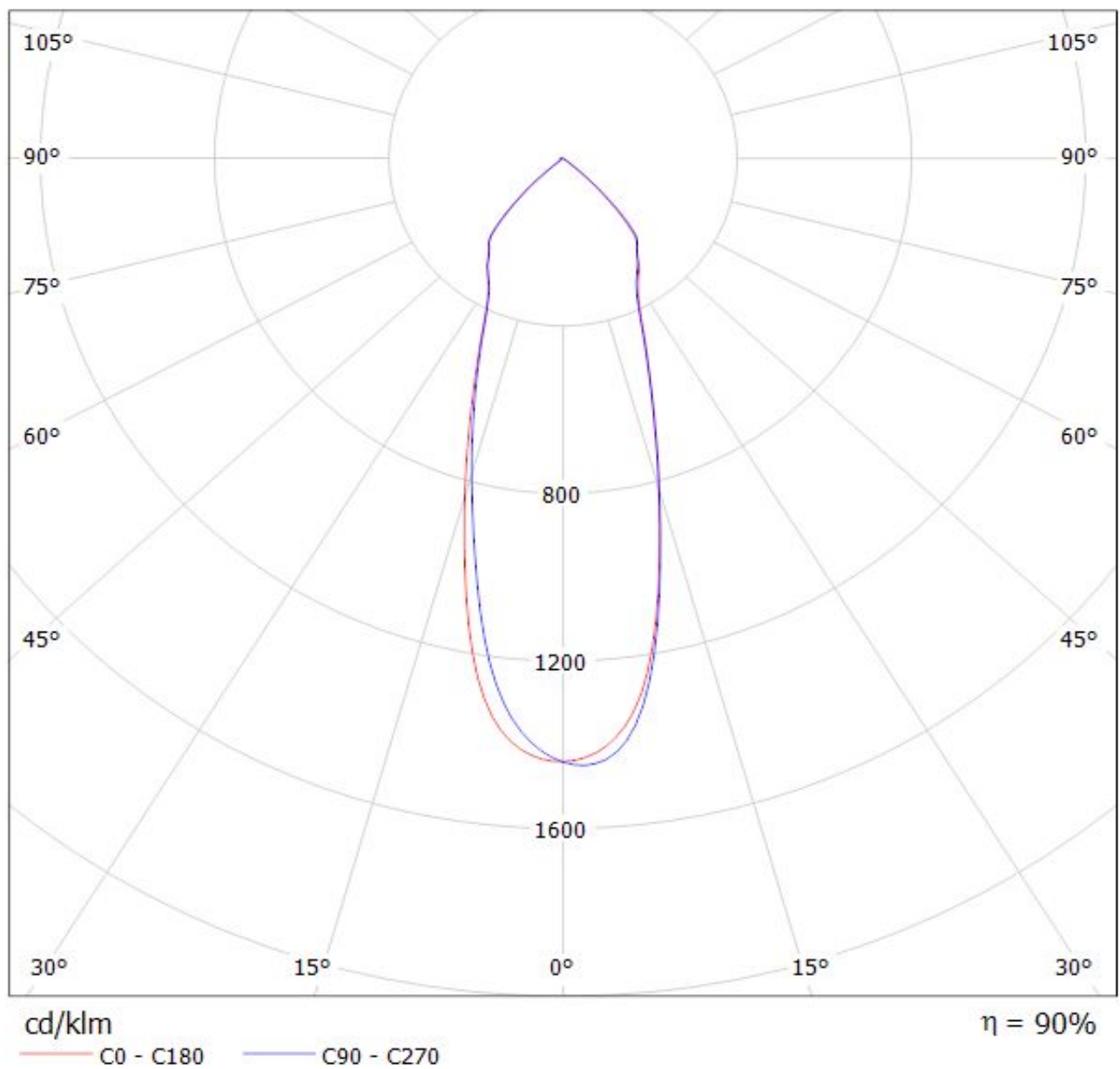

Luminaire: LEDiL Oy F13401_ANGELINA-M_(FORTIMO_3000) Eff.90.3%
Lamps: 1 x PHILIPS Fortimo LED SLM 3000 28W/830 L19 G3 1046.76lm@250mA CCT=3000K P=9W I=250mA

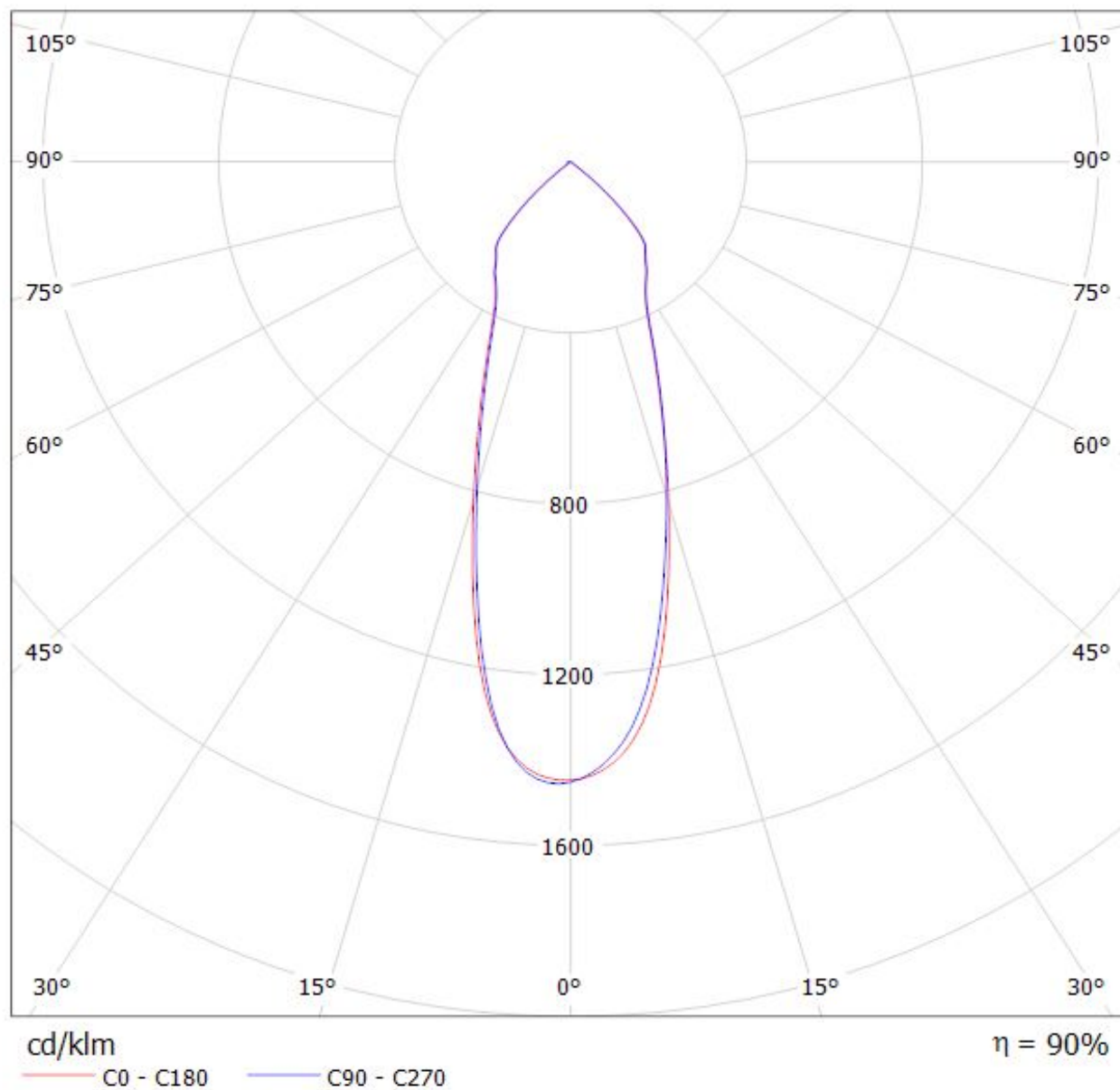

Luminaire: LEDiL Oy F13401_ANGELINA-M_(FORTIMO_3000) Eff.90.3%
Lamps: 1 x PHILIPS Fortimo LED SLM 3000 28W/830 L19 G3 1046.76lm@250mA CCT=3000K P=9W I=250mA

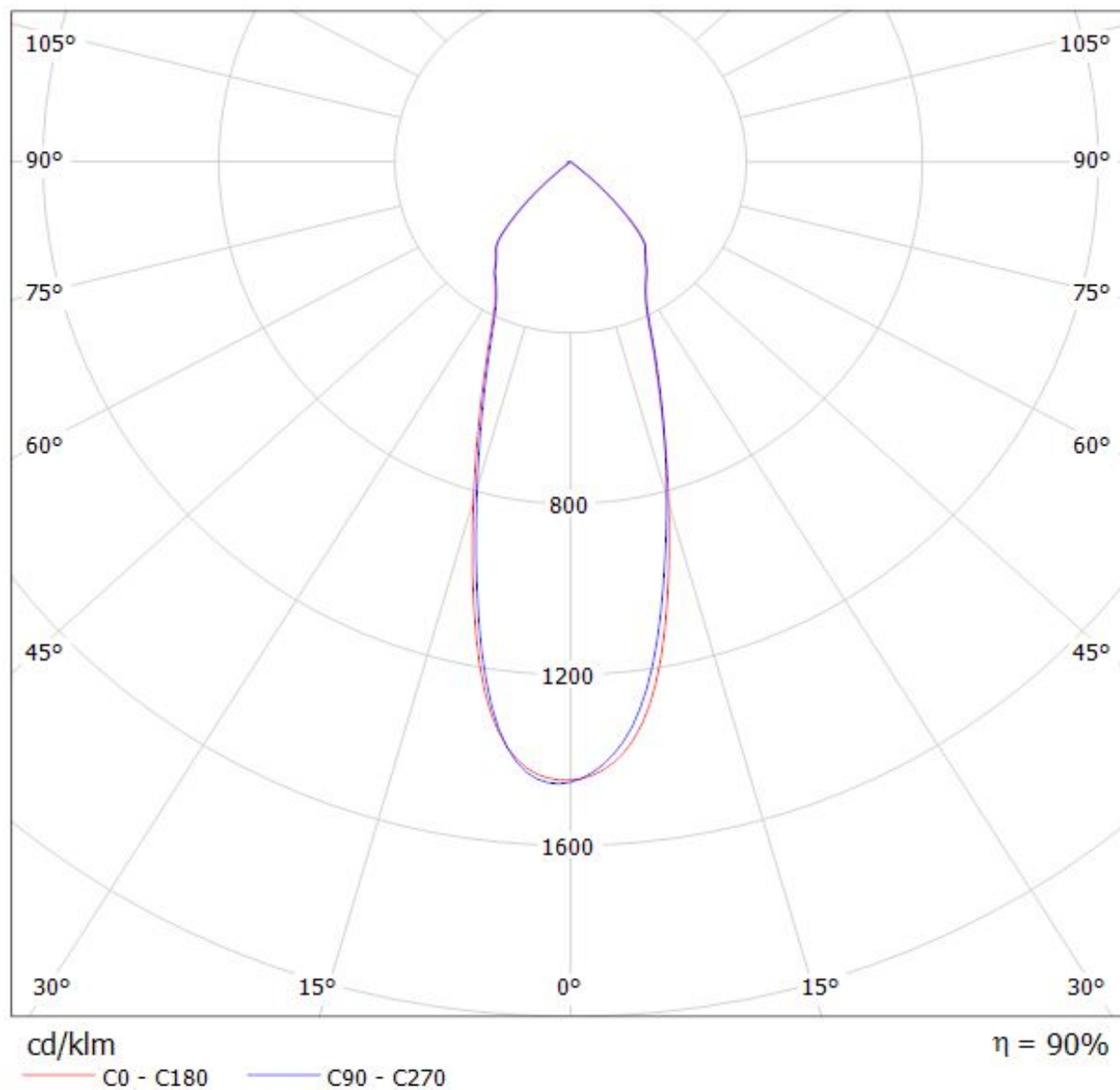

Luminaire: LEDiL Oy F13401_ANGELINA-M_(Fortimo LED SLM 1100 lm 830 L9 G4)
Lamps: 1 x Fortimo LED SLM 1100 lm 830 L9 G4_1021.27lm@250mA_P=9.2431W_I=0.2498A

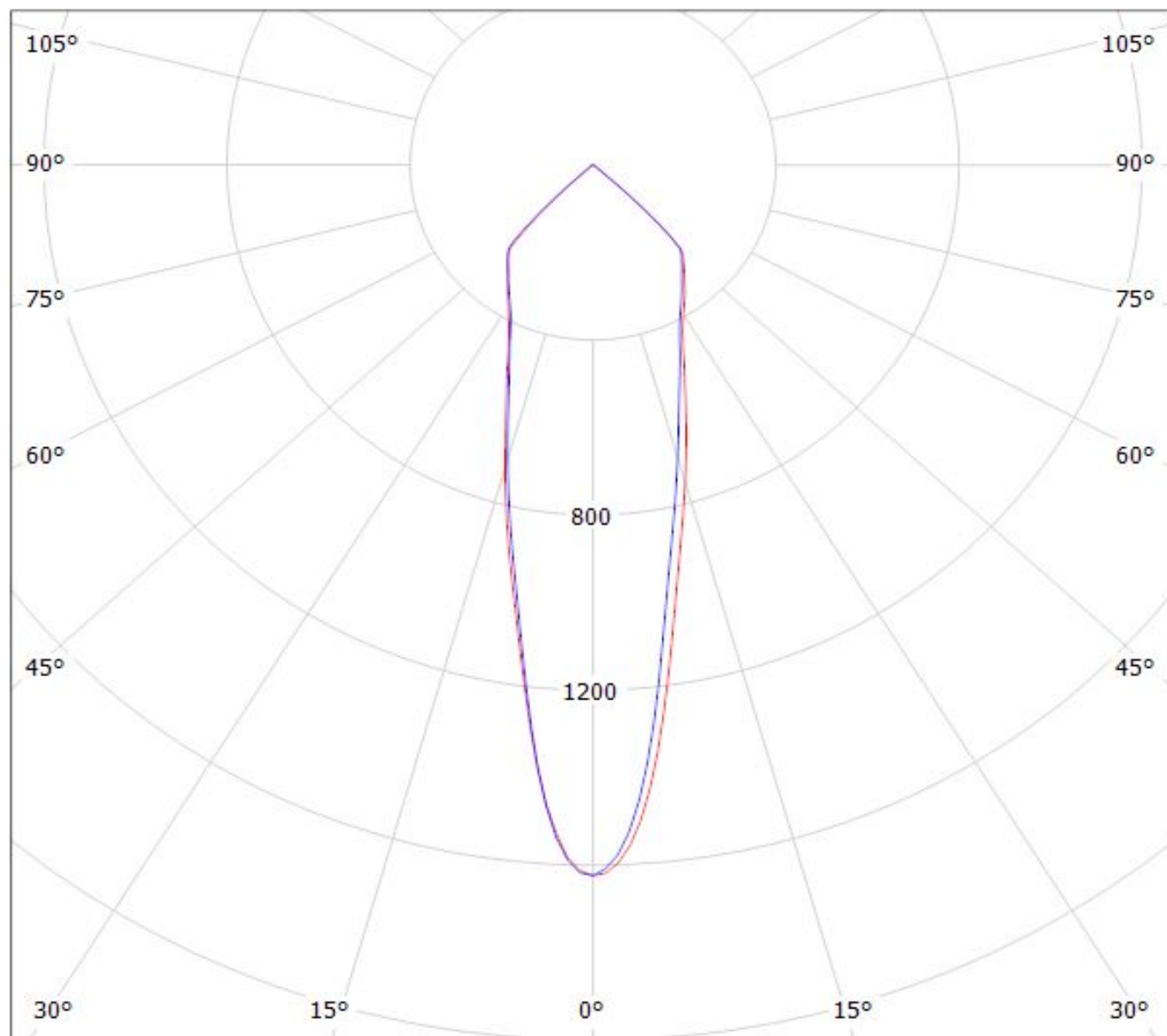

cd/klm

— C0 - C180

— C90 - C270

$\eta = 92\%$

Luminaire: LEDiL Oy F13401_ANGELINA-M_(Fortimo LED SLM L13 G4)
Lamps: 1 x Fortimo LED SLM L13 G4_1106.74lm@250mA_P=8.38104W_η=0.2498A

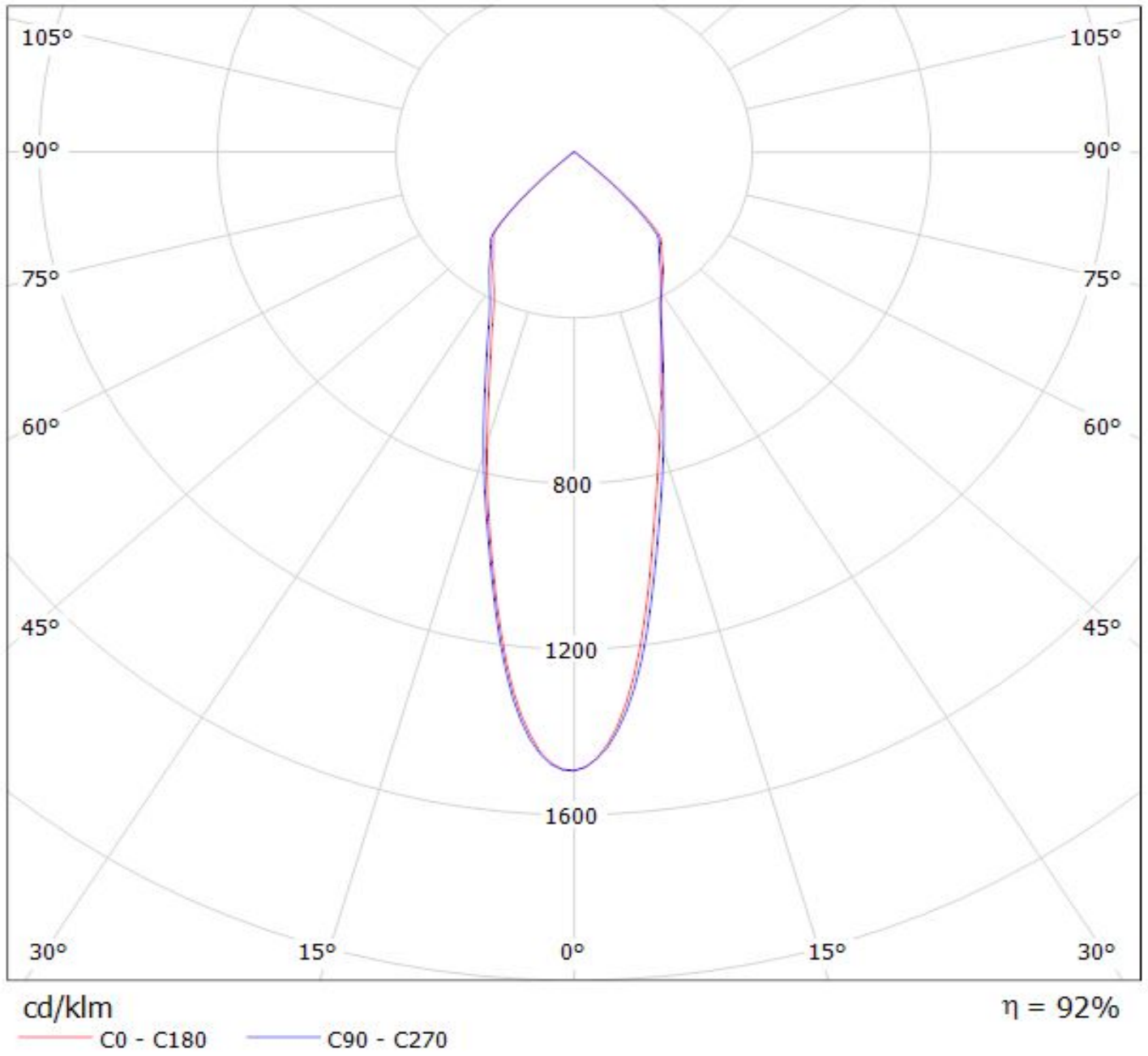

Luminaire: LEDiL Oy F13401_ANGELINA-M_(Fortimo LED SLM L15 G4)

Lamps: 1 x Fortimo LED SLM L15 G4_1116.47lm@250mA_P=8.21168W_I=0.2498A

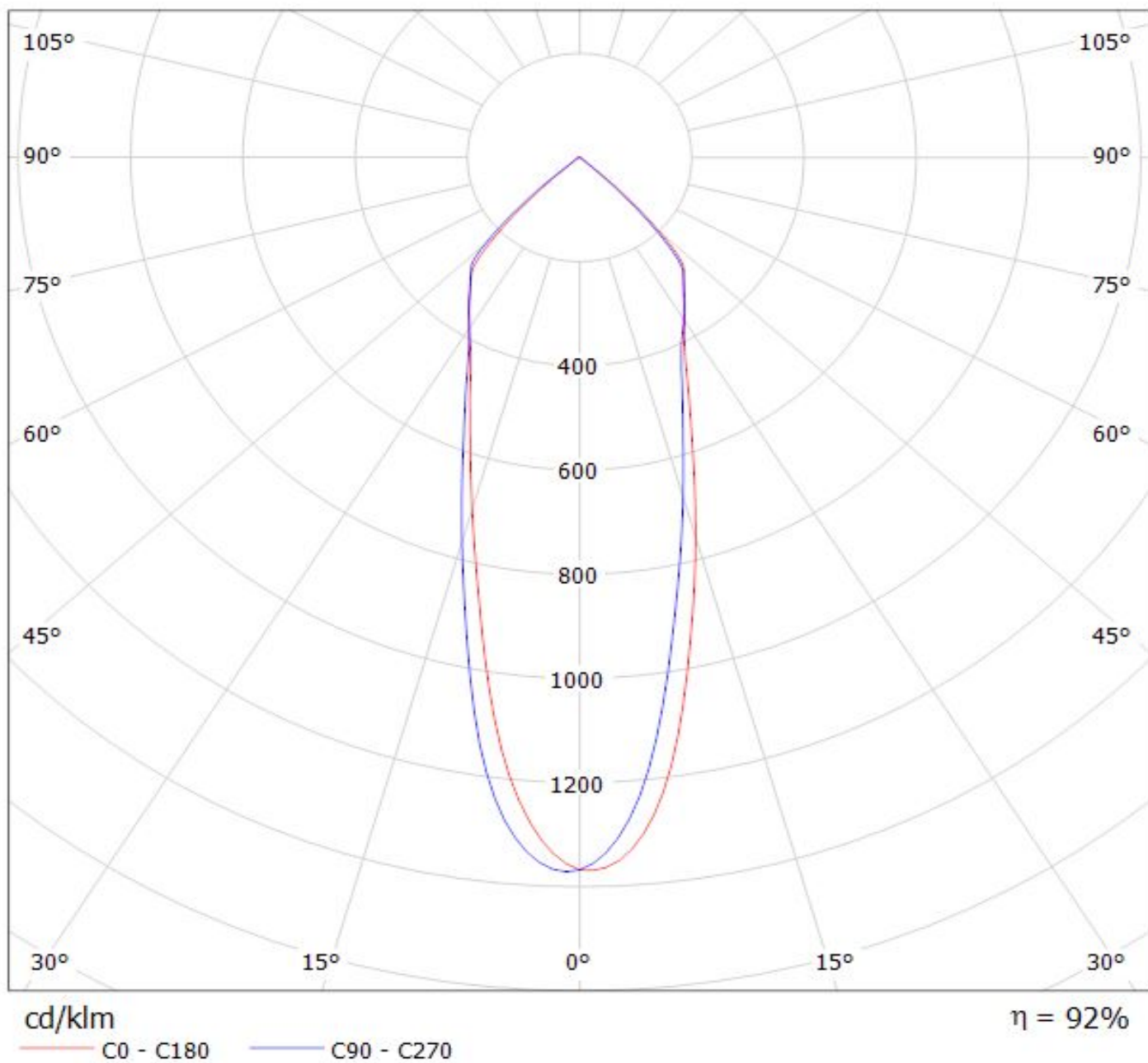

Luminaire: LEDiL Oy F13401_ANGELINA-M_(Fortimo LED SLM L19 G4)

Lamps: 1 x Fortimo LED SLM L19 G4_1114.89lm@250mA_P=8.04906W_I=0.2498A

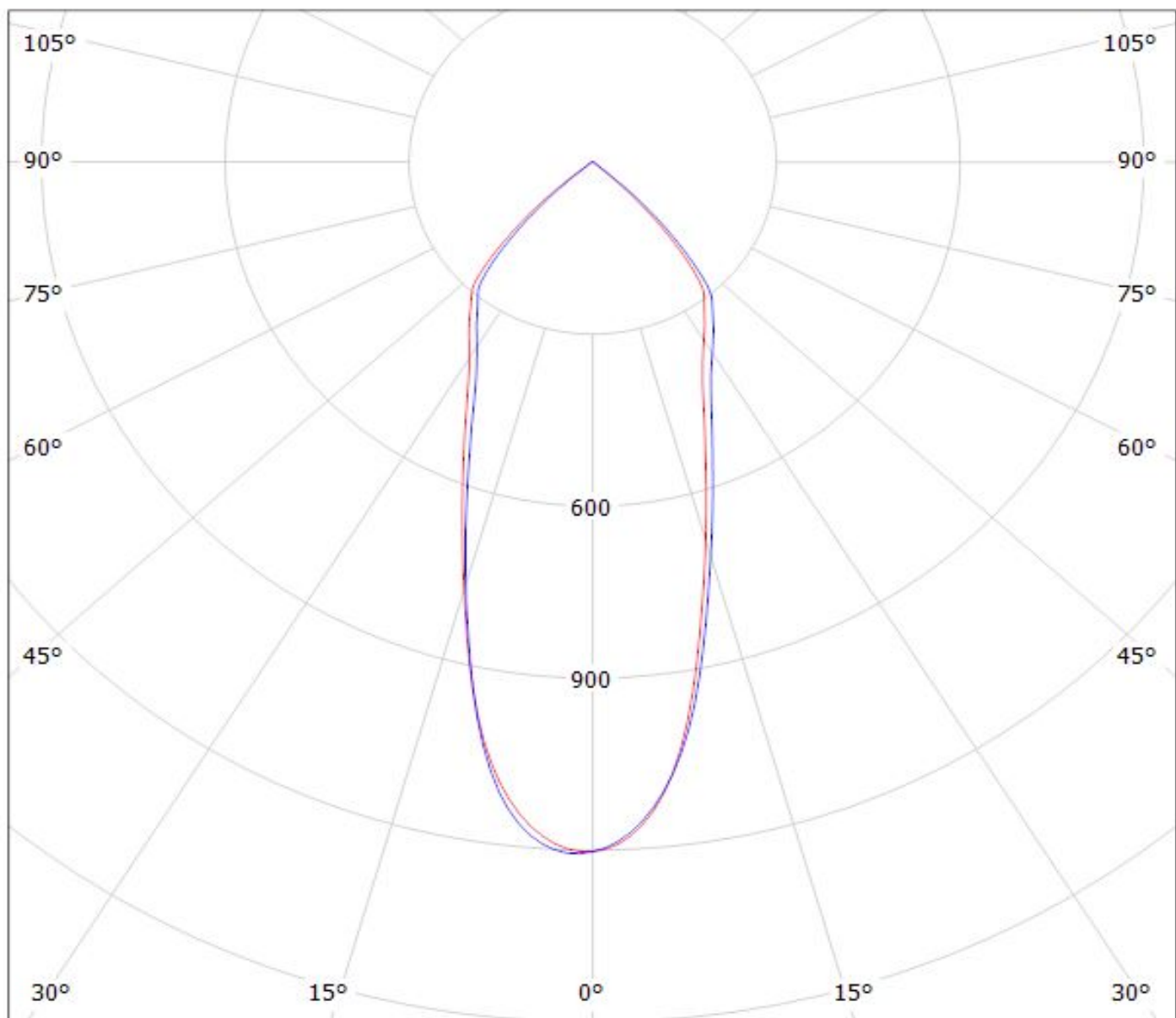

cd/klm

— C0 - C180 — C90 - C270

$\eta = 91\%$

Luminaire: LEDiL Oy F13401_ANGELINA-M_(SLM-G5-LES-9)_ (Z50-Optic-Clip)
Lamps: 1 x Fortimo_SLM-G5-LES-9_1182.49lm@250mA_P=8.5848W_I=0.250A

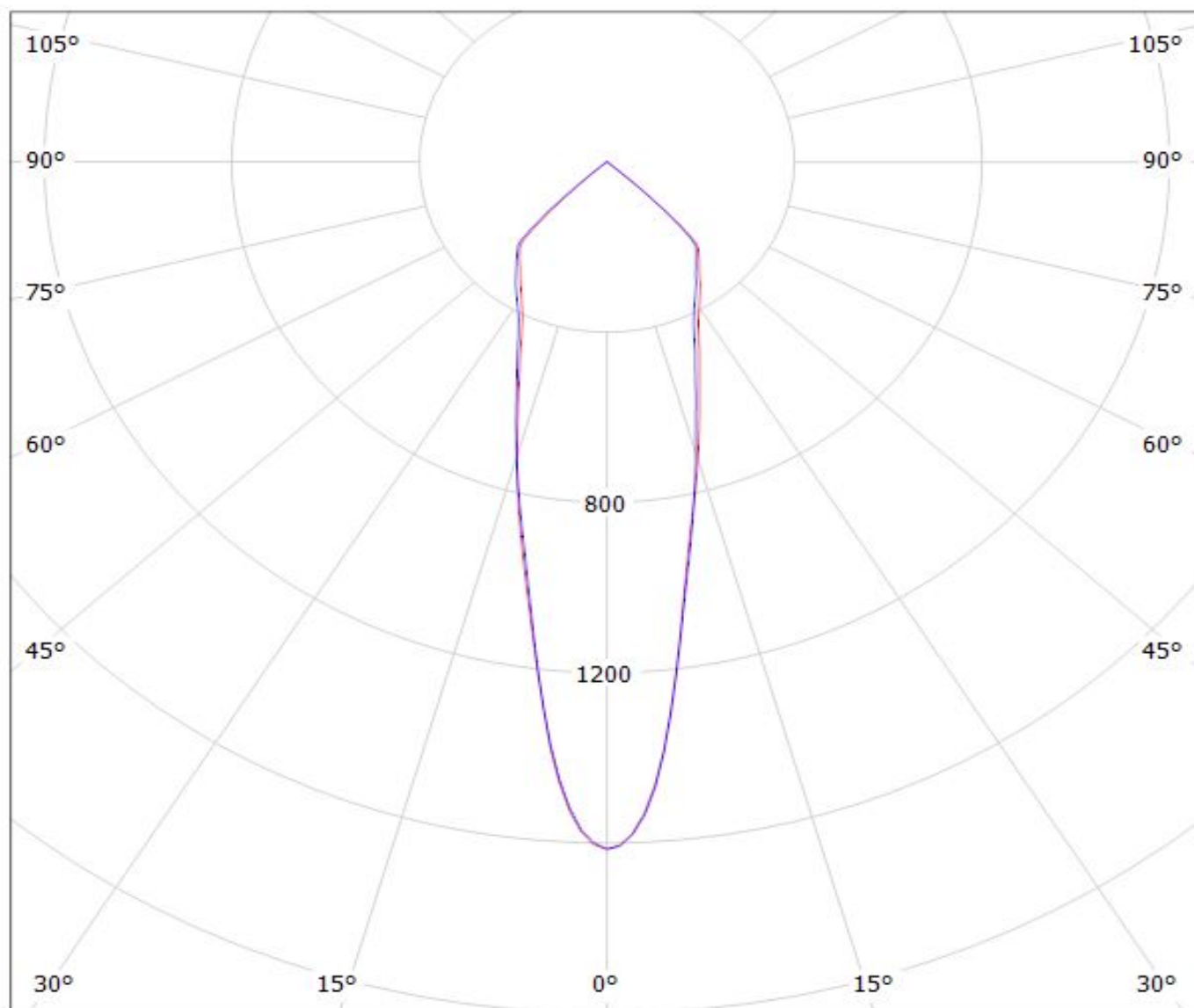

cd/klm

— C0 - C180 — C90 - C270

$\eta = 92\%$

Luminaire: LEDiL Oy F13401_ANGELINA-M_(SLM-G5-LES-9)_(Z50-Optic-Clip)
Lamps: 1 x Fortimo_SLM-G5-LES-9_1182.49lm@250mA_P=8.5848W_I=0.250A

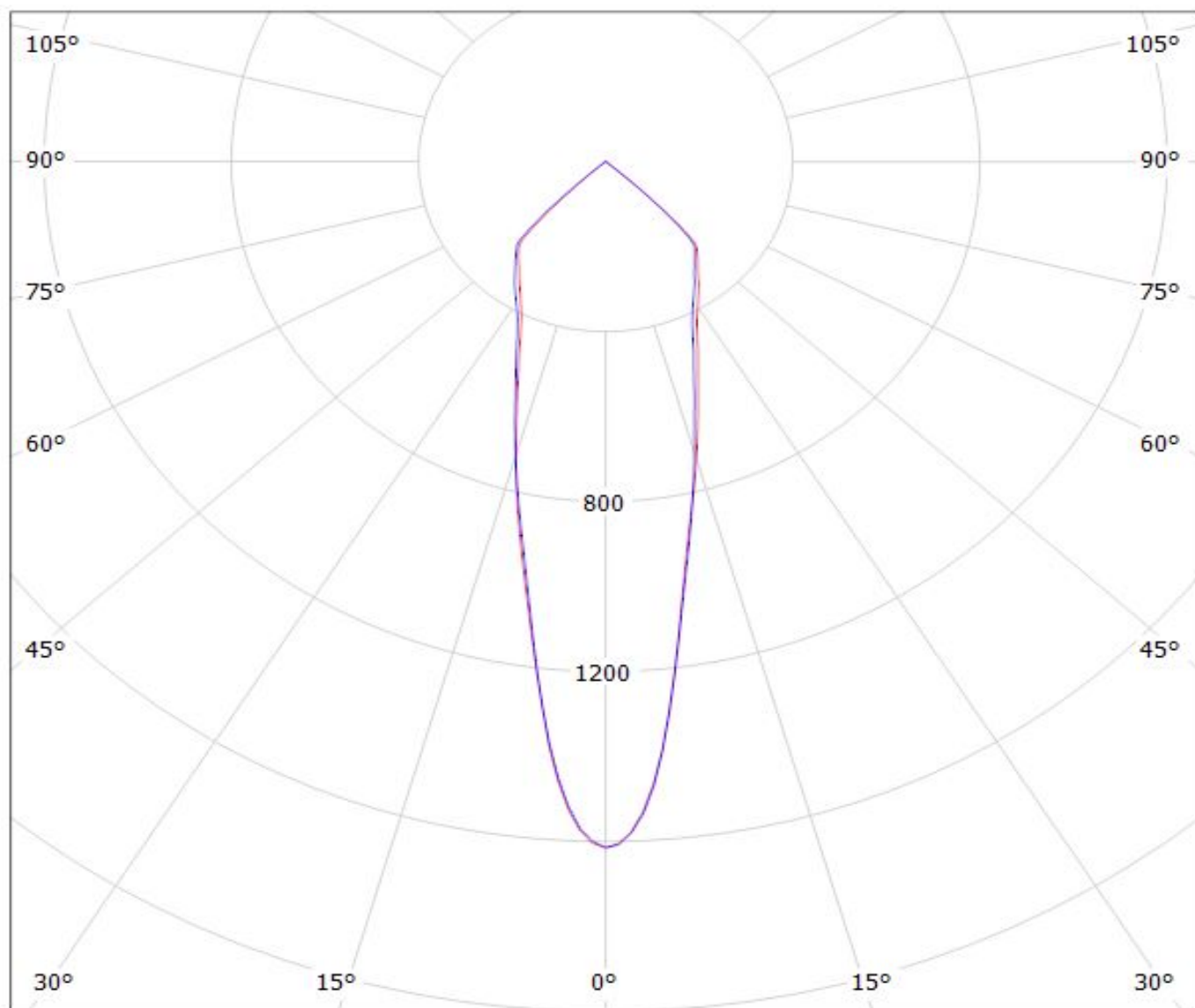

cd/klm

— C0 - C180 — C90 - C270

$\eta = 92\%$

Luminaire: LEDiL Oy F13401_ANGELINA-M_(SLM-G5_LES-15)

Lamps: 1 x Fortimo_SLM-G5_LES-15_1257.61lm@250mA_P=8.1569W_I=0.250A

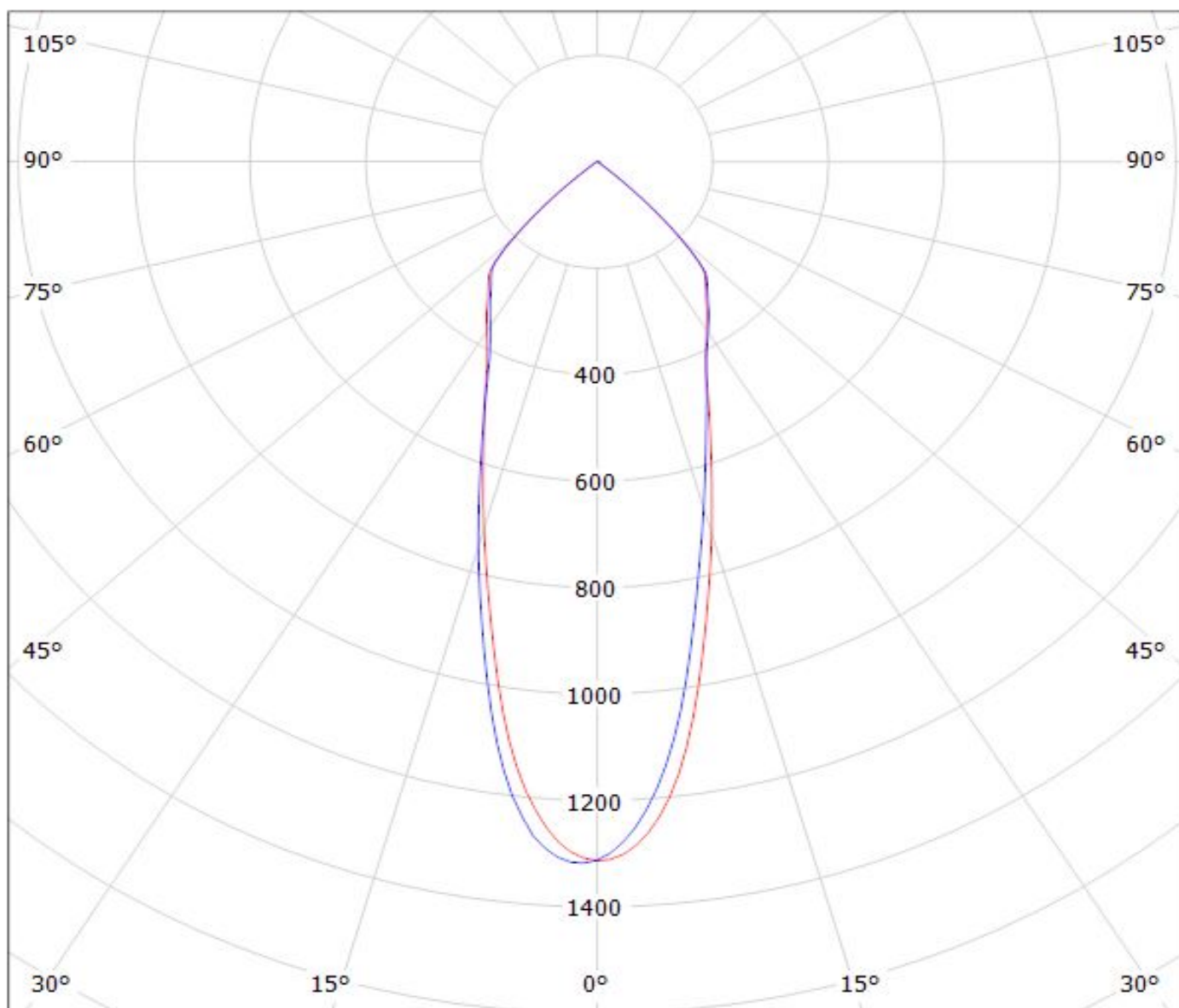

cd/klm

— C0 - C180

— C90 - C270

$\eta = 90\%$

Luminaire: LEDiL Oy F13401_ANGELINA-M_(SLM-G5_LES-19)_(Z50_Optic_Clip)
Lamps: 1 x Fortimo_SLM-G5_LES-19_1397.58lm@250mA_P=8.0385W_I=0.250A

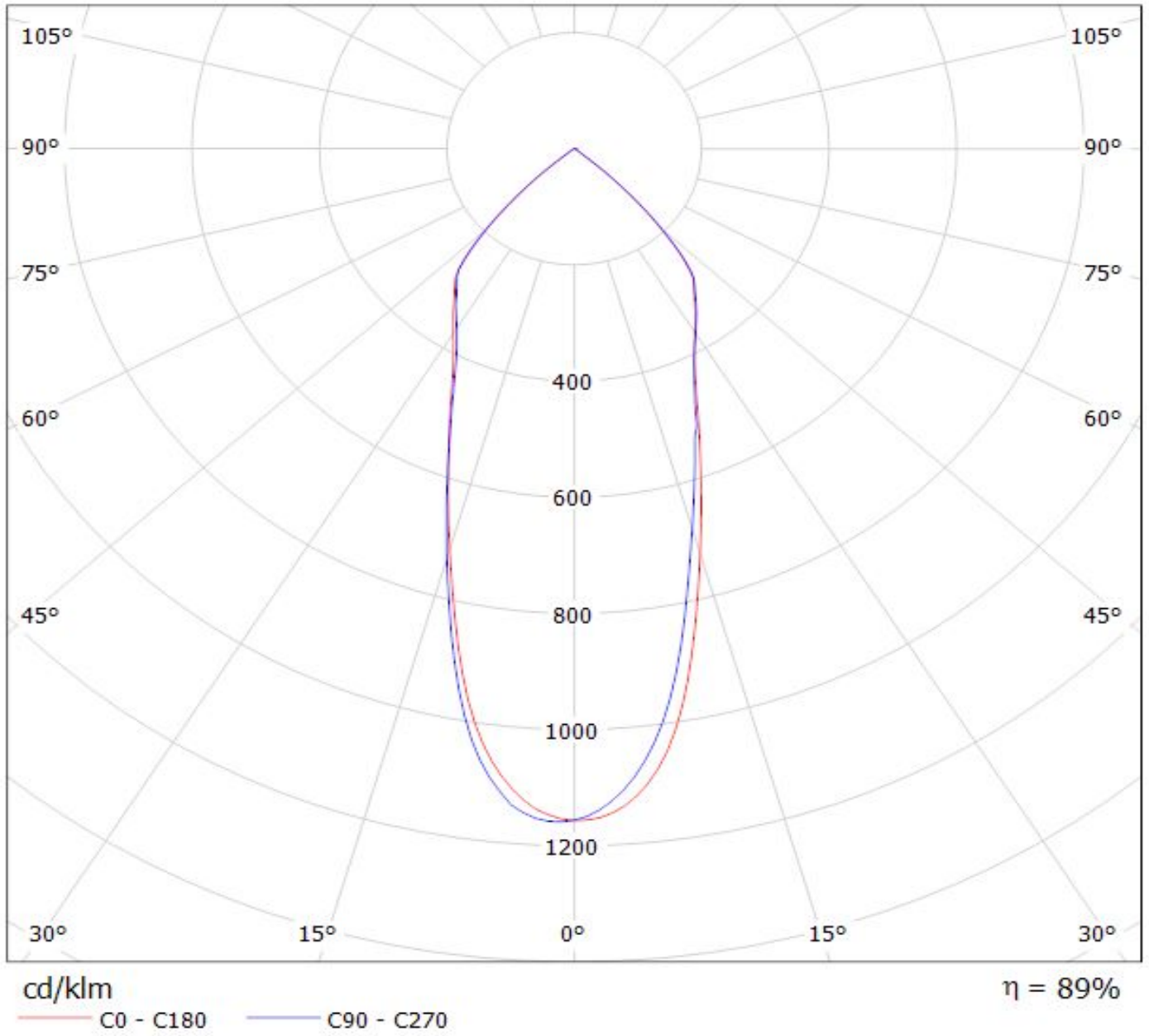

Luminaire: LEDiL Oy F13401_ANGELINA-M_(SLM-G5_LES-13)_ (Z50-Optic-Clip)
Lamps: 1 x Fortimo_SLM-G5_LES-13_1300.47lm@250mA_P=8.4010W_I=0.250A

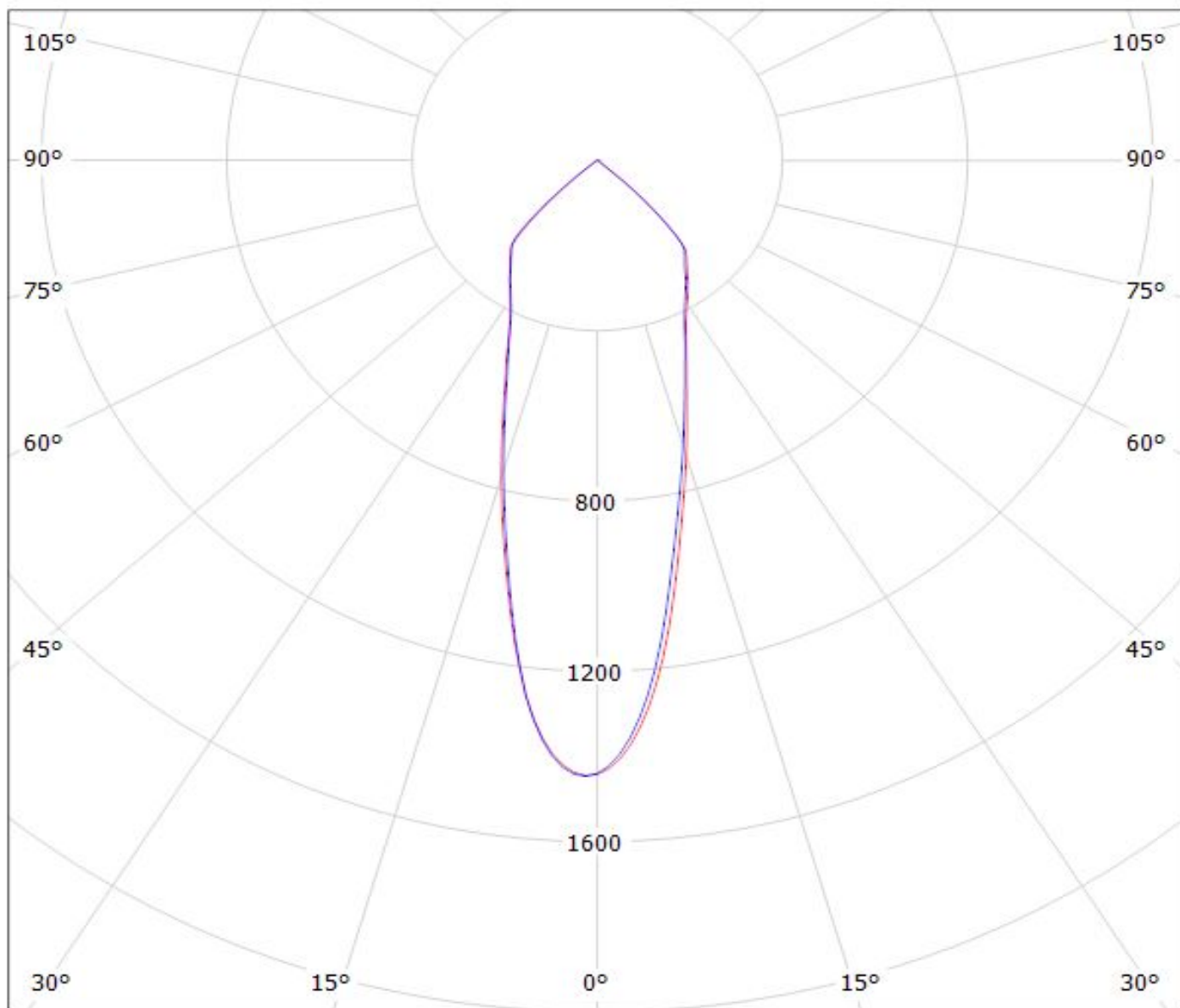

cd/klm

— C0 - C180 — C90 - C270

$\eta = 91\%$

Luminaire: Ledil F13401_ANGELINA-M_(SLM_1211_L19_G6_+TE)

Lamps: 1 x Philips_Fortimo_SLM_1211_L19_G6_Standard_+_TE_OPTIC_CLIP_Z50_TYPE1:_2213194-1_1146.84lm@250mA_P=8.13175W_I=0.25A

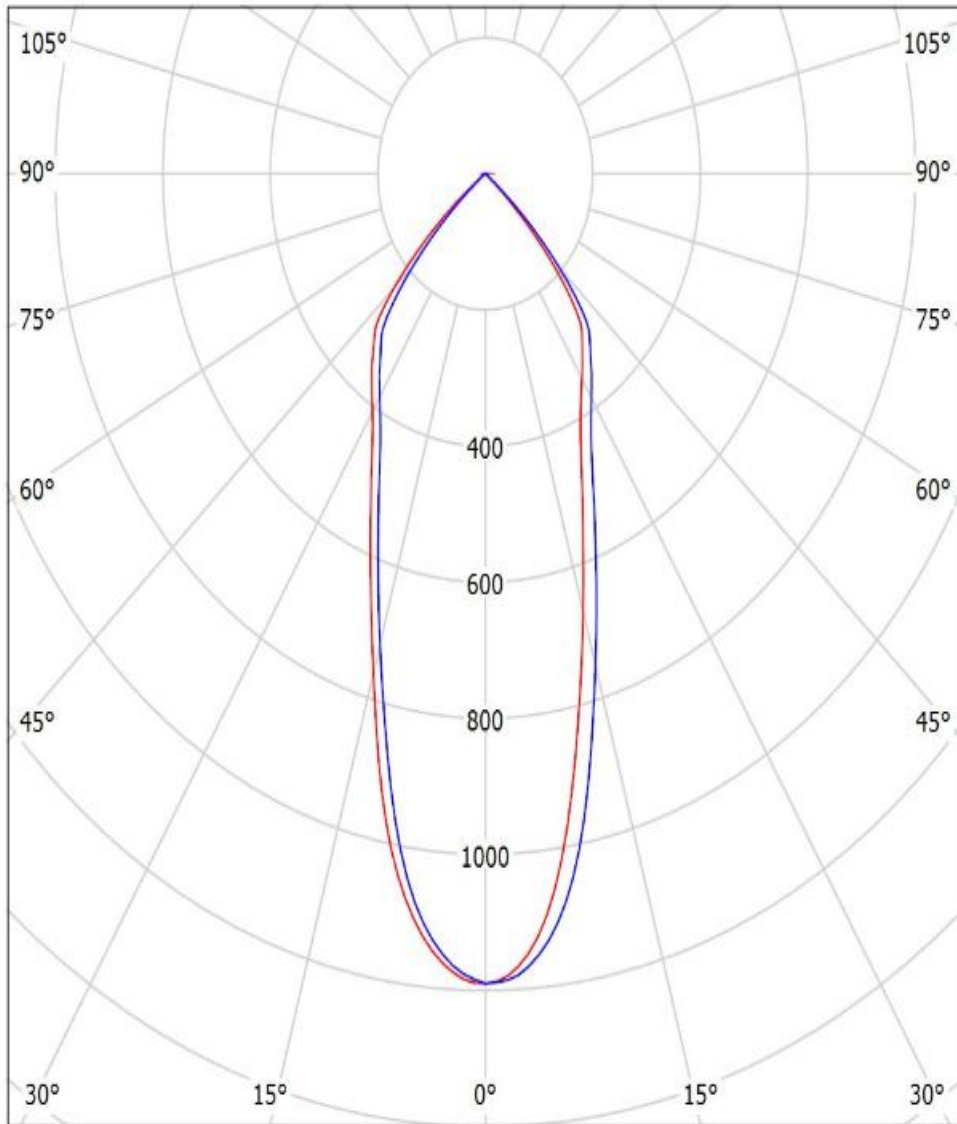

cd/klm

— C0 - C180 — C90 - C270

$\eta = 91\%$

Luminaire: LEDiL Oy F13325_ANGELINA-S_(COB-LC026B) Eff.93.5%

Lamps: 1 x SAMSUNG_COB-LC026B_(SPHWWTHDNC25YHV52F)_1136.23lm@250mA_P=8.23191W_I=249.8mA

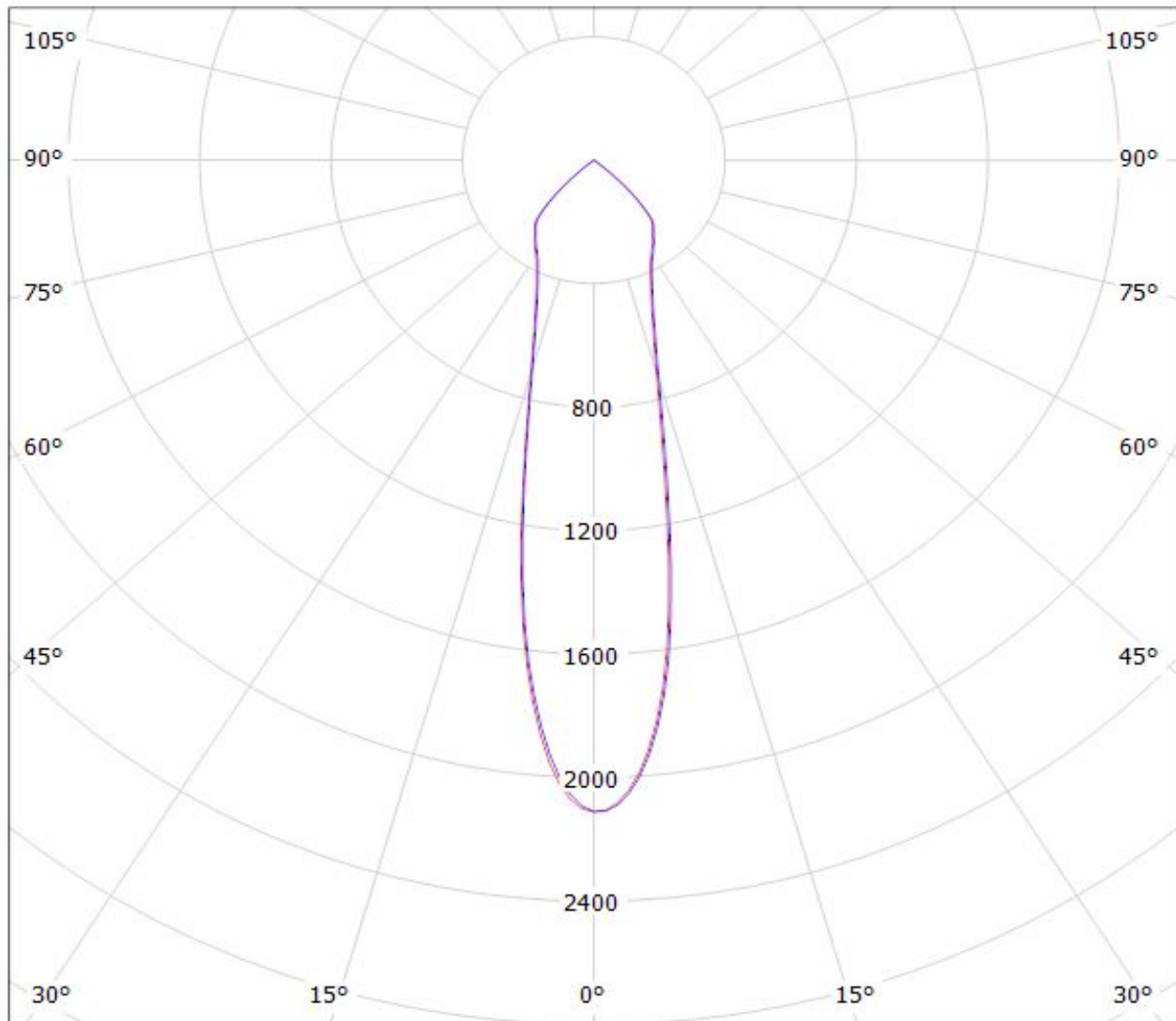

cd/klm

— C0 - C180

— C90 - C270

$\eta = 93\%$

Luminaire: Ledil F13401_ANGELINA-M_(LC040C+TE)

Lamps: 1 x Samsung_LC040C+_2213382-2+_2213194-1_1194.16lm@250mA_CCT=4000K_P=8.137W

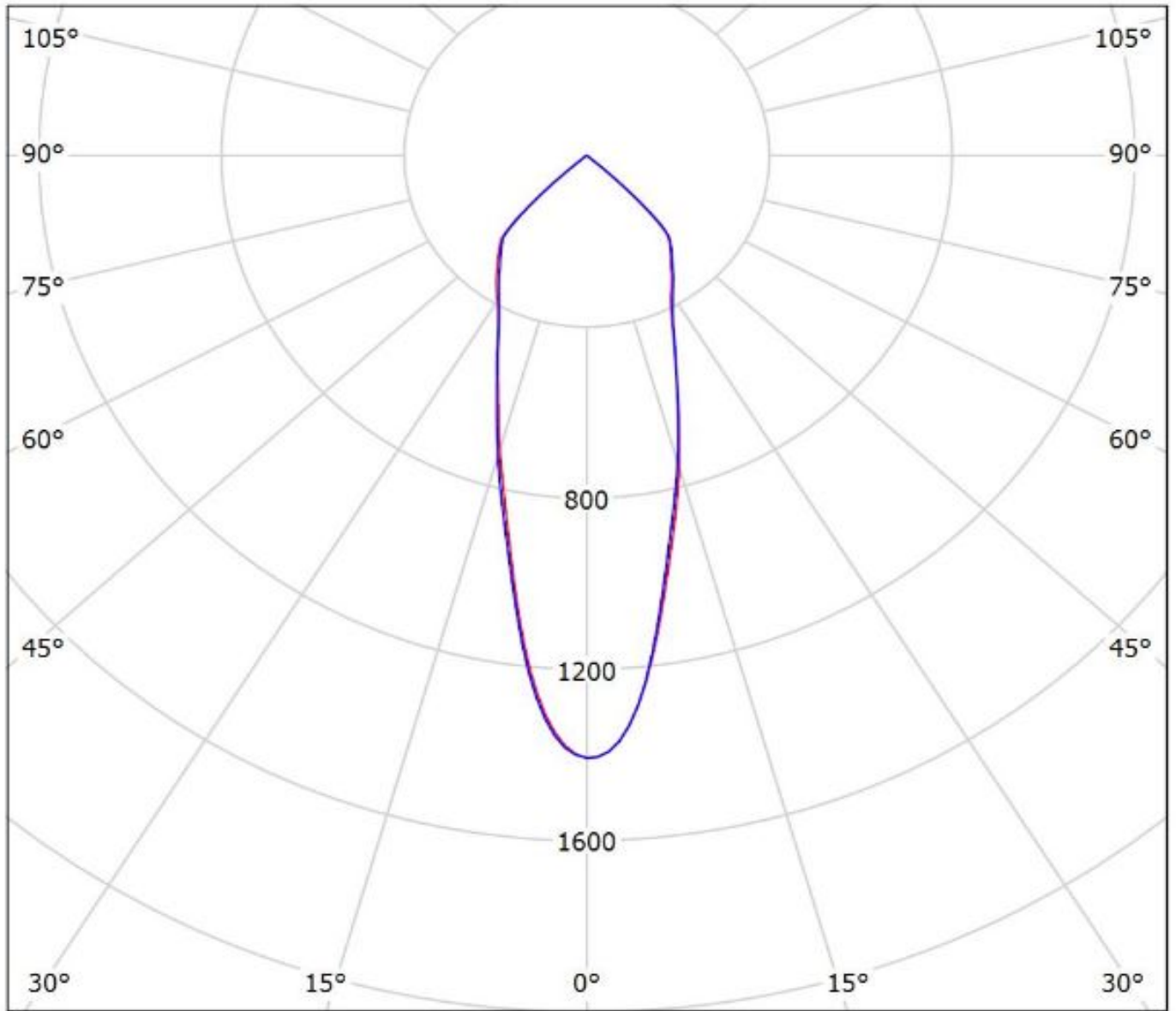

cd/klm

— C0 - C180

— C90 - C270

$\eta = 91\%$

Luminaire: LEDiL Oy F13401_ANGELINA-M_(MegaZenigata) 92.0%
Lamps: 1 x MegaZenigata_GW6DME (518.495lm@100mA)

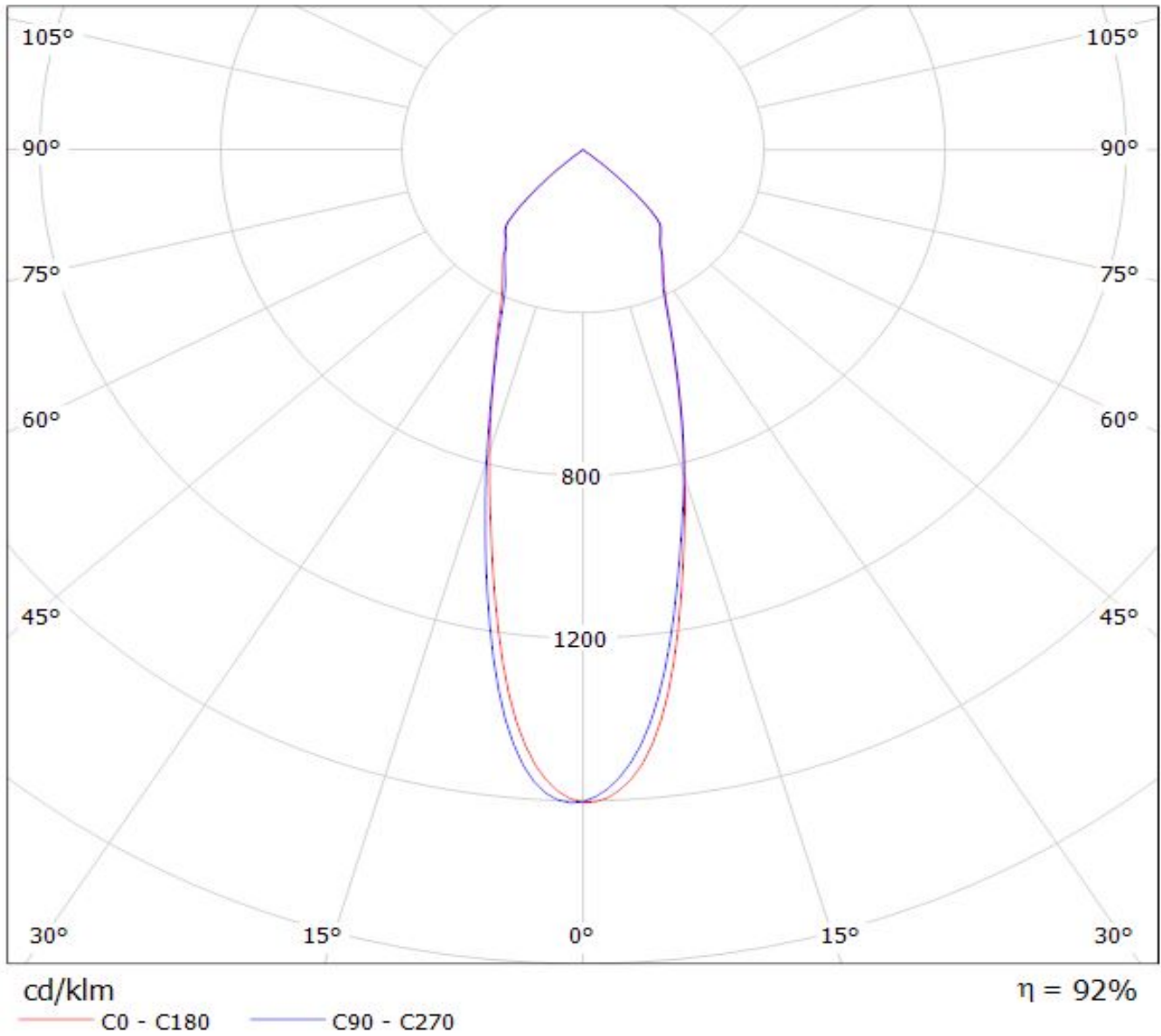

Luminaire: LEDiL Oy F13401_ANGELINA-M_(MEGAZENIGATA) Eff.92.5%
Lamps: 1 x SHARP_MEGAZENIGATA_(GW6DME30NFC)_1238.26lm@250mA_CCT=3000K_P=11.1211W_I=249.8mA

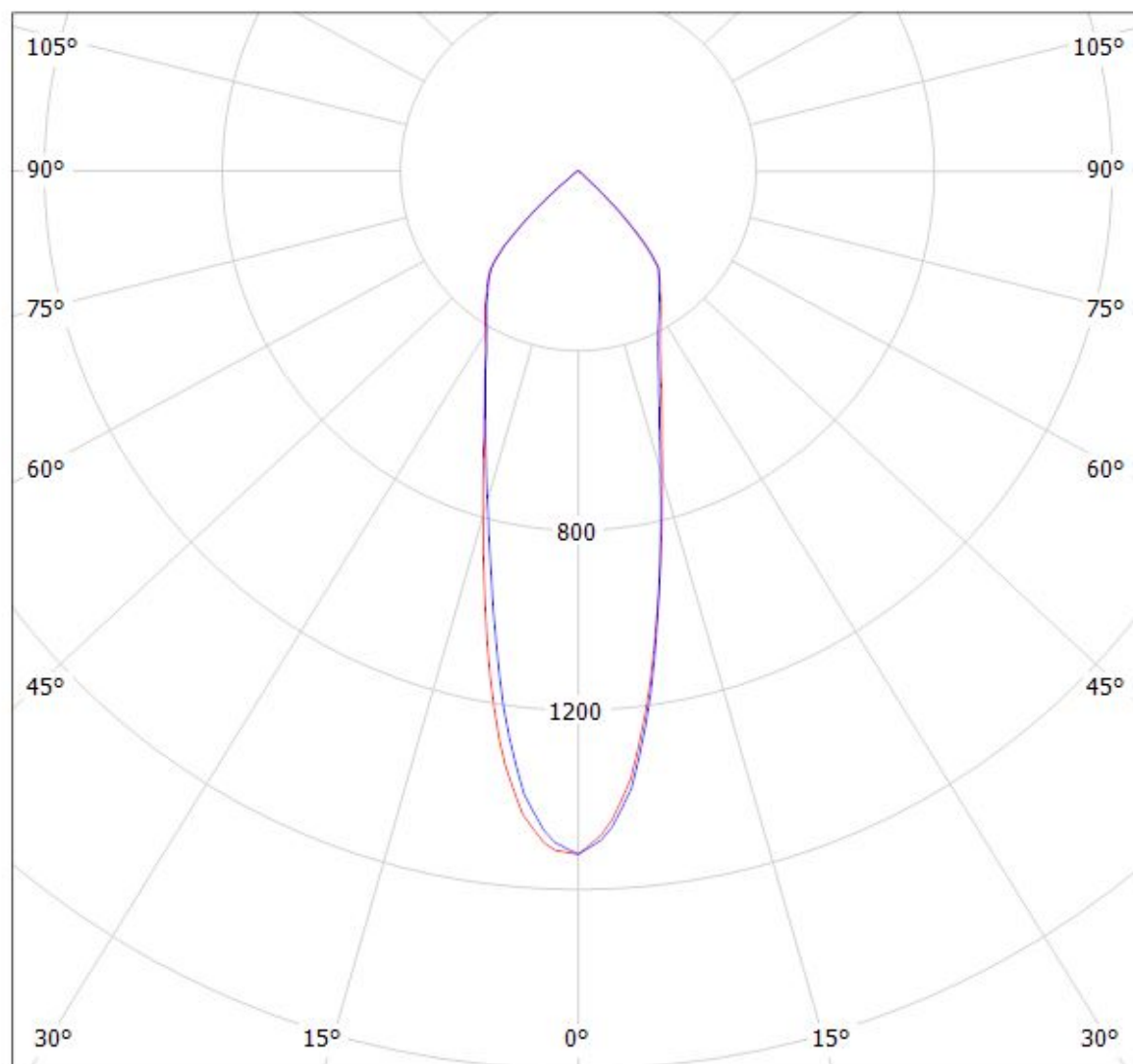

cd/klm

— C0 - C180 — C90 - C270

$\eta = 93\%$

Luminaire: LEDiL Oy F13401_ANGELINA-M_(STARK_SLE_G2_LES19) Eff.91.6%
Lamps: 1 x TRIDONIC STARK SLE G2 LES19 830 CLA 964.643lm@250mA CCT=3000K P=8W I=250mA

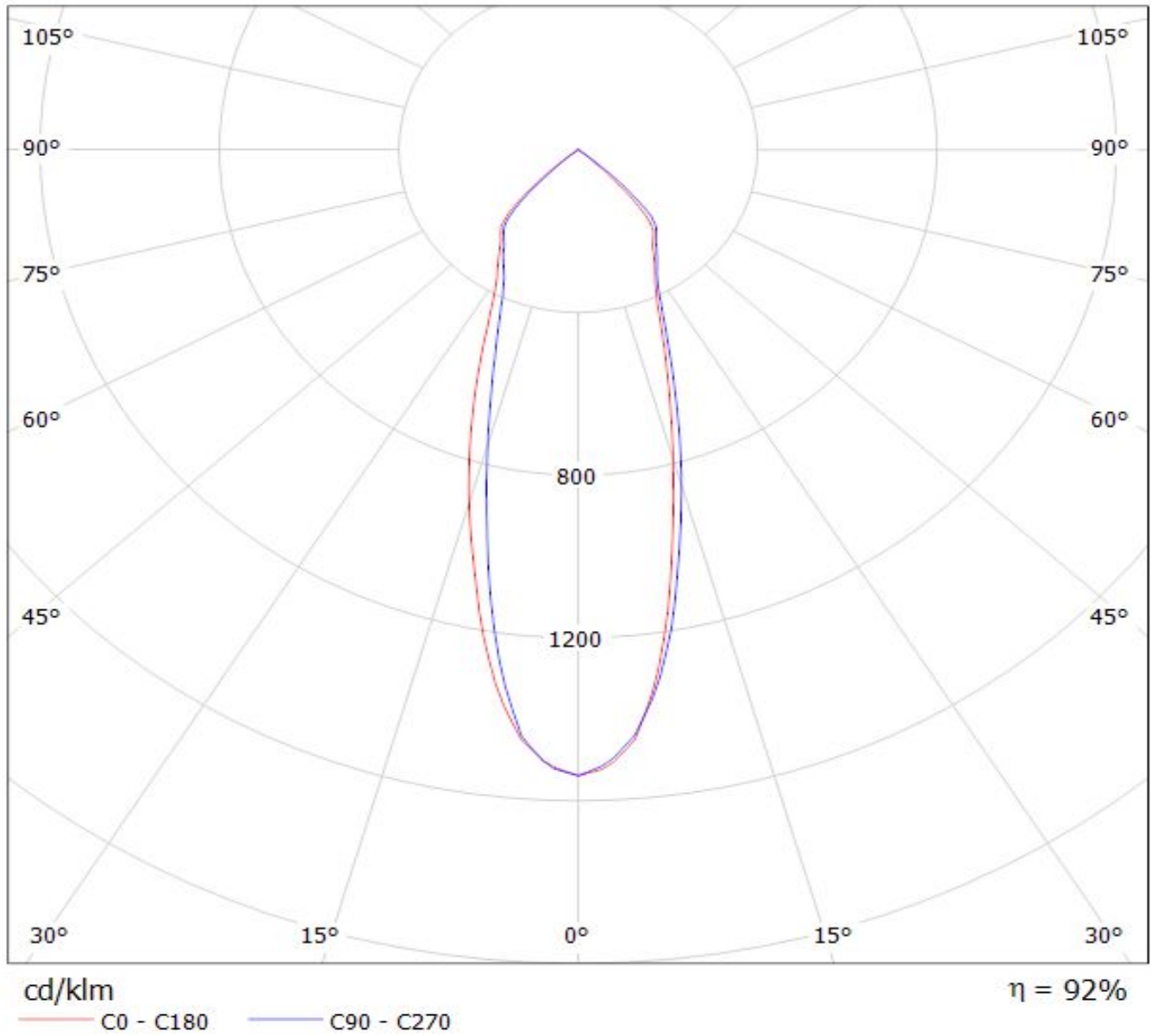

Luminaire: LEDiL Oy F13401_ANGELINA-M_(STARK_SLE_G2_LES23) Eff.90.2%

Lamps: 1 x TRIDONIC STARK SLE G2 LES23 830 CLA 982.731lm@250mA CCT=3000K P=8W I=250mA

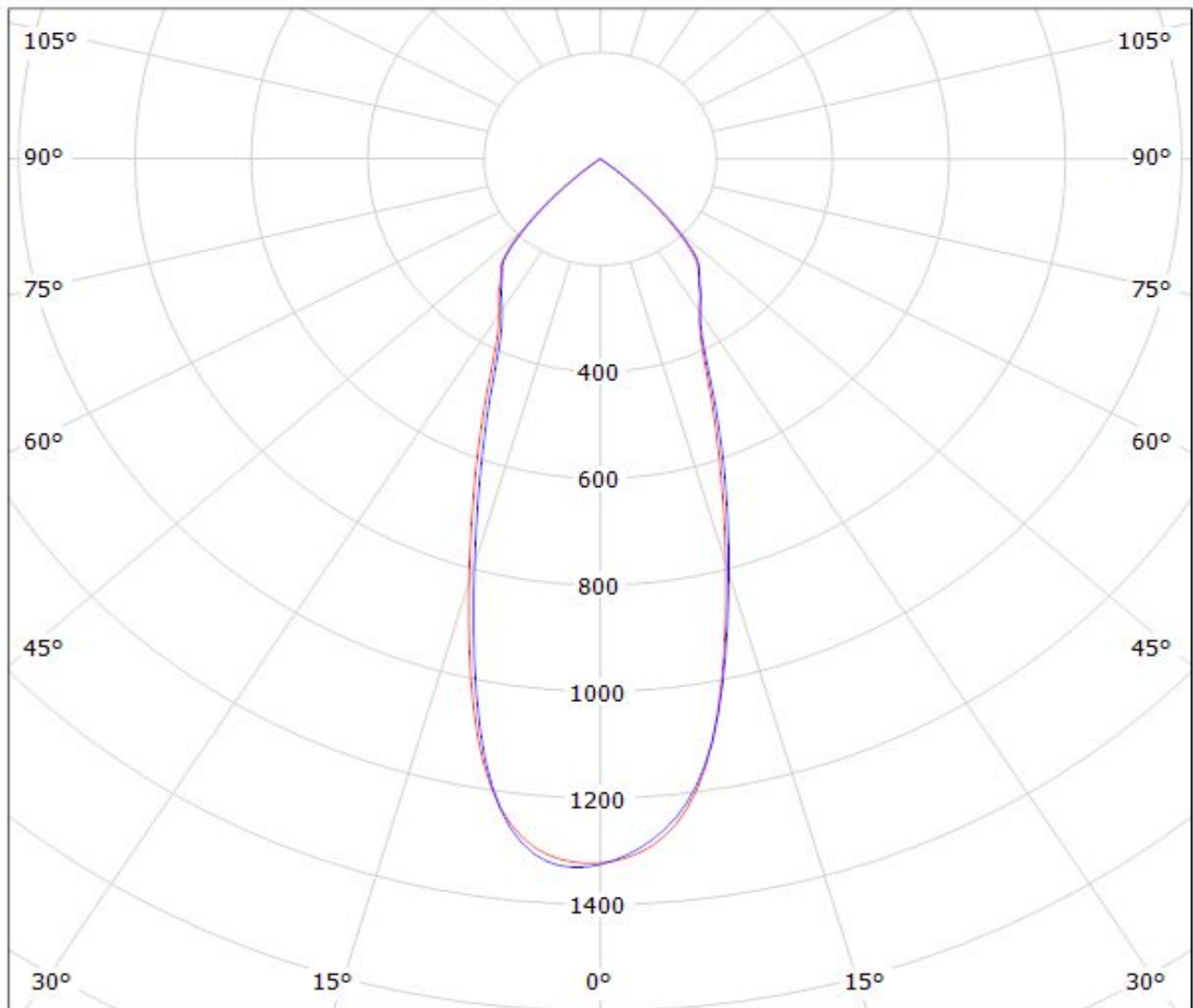

cd/klm

— C0 - C180

— C90 - C270

$\eta = 90\%$

Luminaire: LEDiL Oy F13401_ANGELINA-M_(STARK_SLE_G2_LES26) Eff.89.0%
Lamps: 1 x TRIDONIC STARK SLE G2 LES26 830 CLA 1095.88lm@250mA CCT=3000K P=8W I=250mA

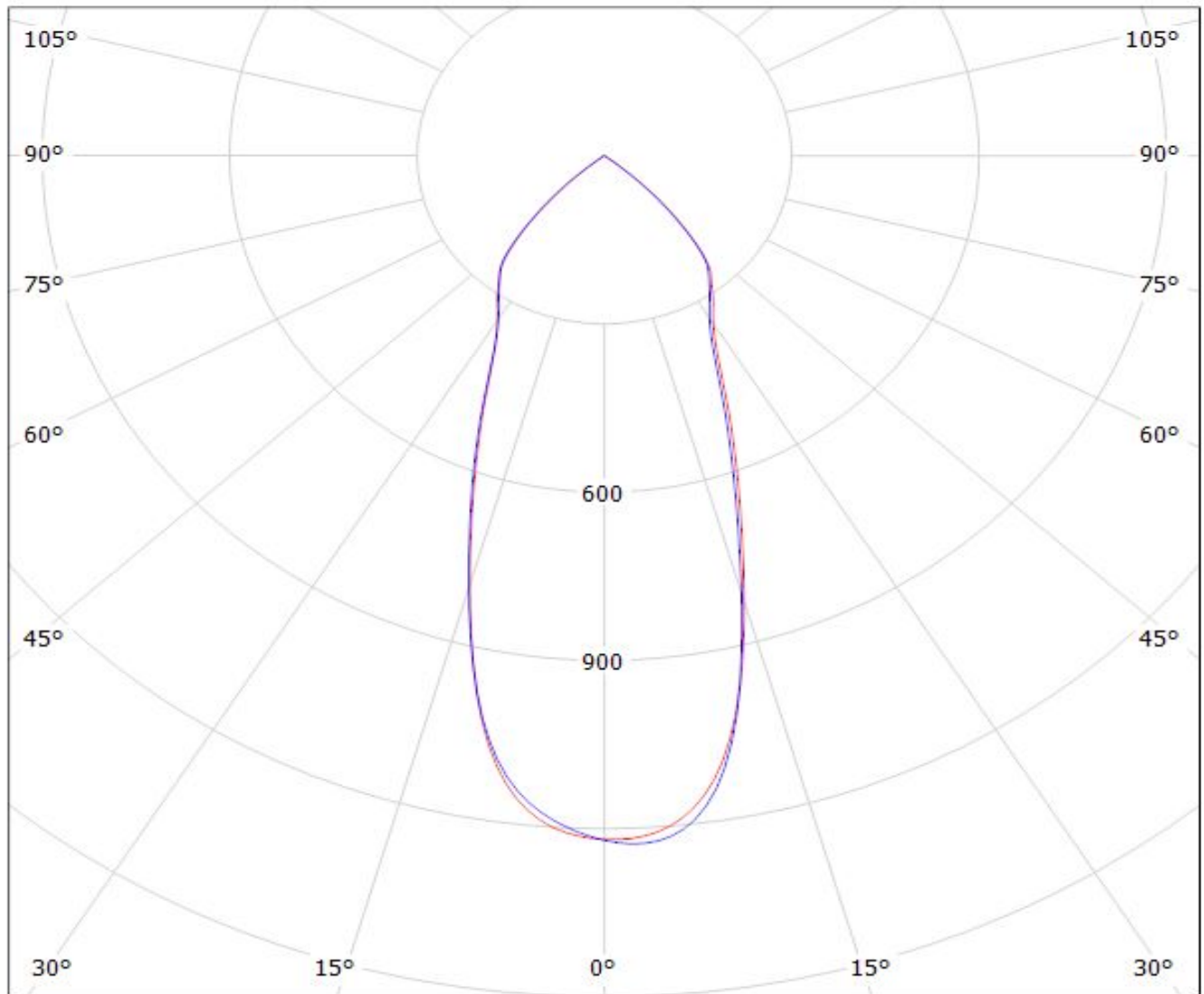

cd/klm

— C0 - C180 — C90 - C270

$\eta = 89\%$

Luminaire: LEDiL Oy F13401_ANGELINA-M_(SLE_G3_LES19) Eff.92.1%

Lamps: 1 x TRIDONIC_STARK_SLE_G3_LES19_(STARK-SLE-G3-LES19-2000-840-CLA)_1058.33lm@250mA_P=8.32833W_I=249.8mA

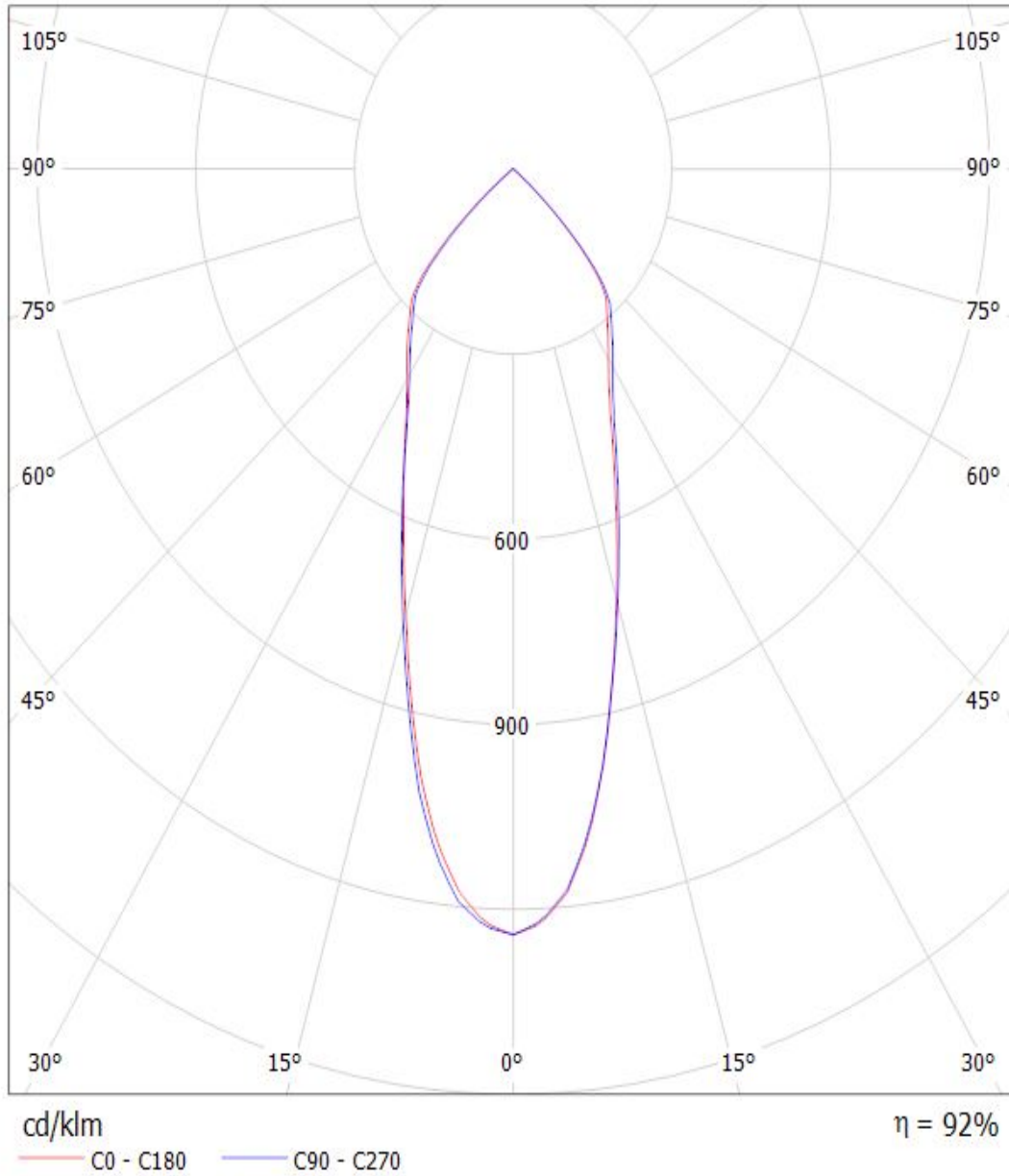

Luminaire: LEDiL Oy F13401_ANGELINA-M_(SLE_G3_LES23) Eff.90.0%

Lamps: 1 x TRIDONIC_STARK_SLE_G3_LES23_(STARK-SLE-PURE_G3-23-3000-930-SEL)_813.196lm@250mA_CCT=3000K_P=8.20018W_I=249.8mA

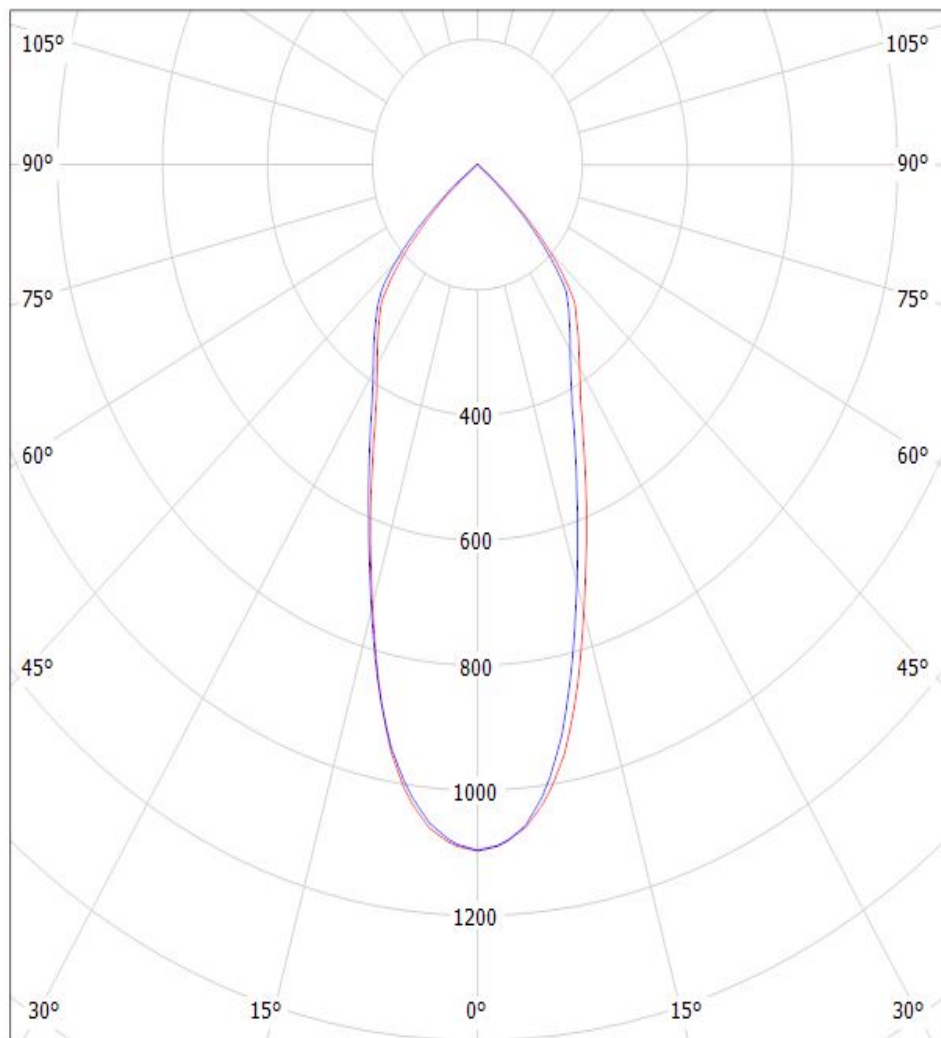

cd/klm

— C0 - C180

— C90 - C270

$\eta = 90\%$

Luminaire: LEDiL Oy F13401_ANGELINA-M_(SLE_G4_LES23)

Lamps: 1 x Tridonic_SLE_G4_LES23_1354.57lm@250mA_P=8.18744W_I=0.2498A

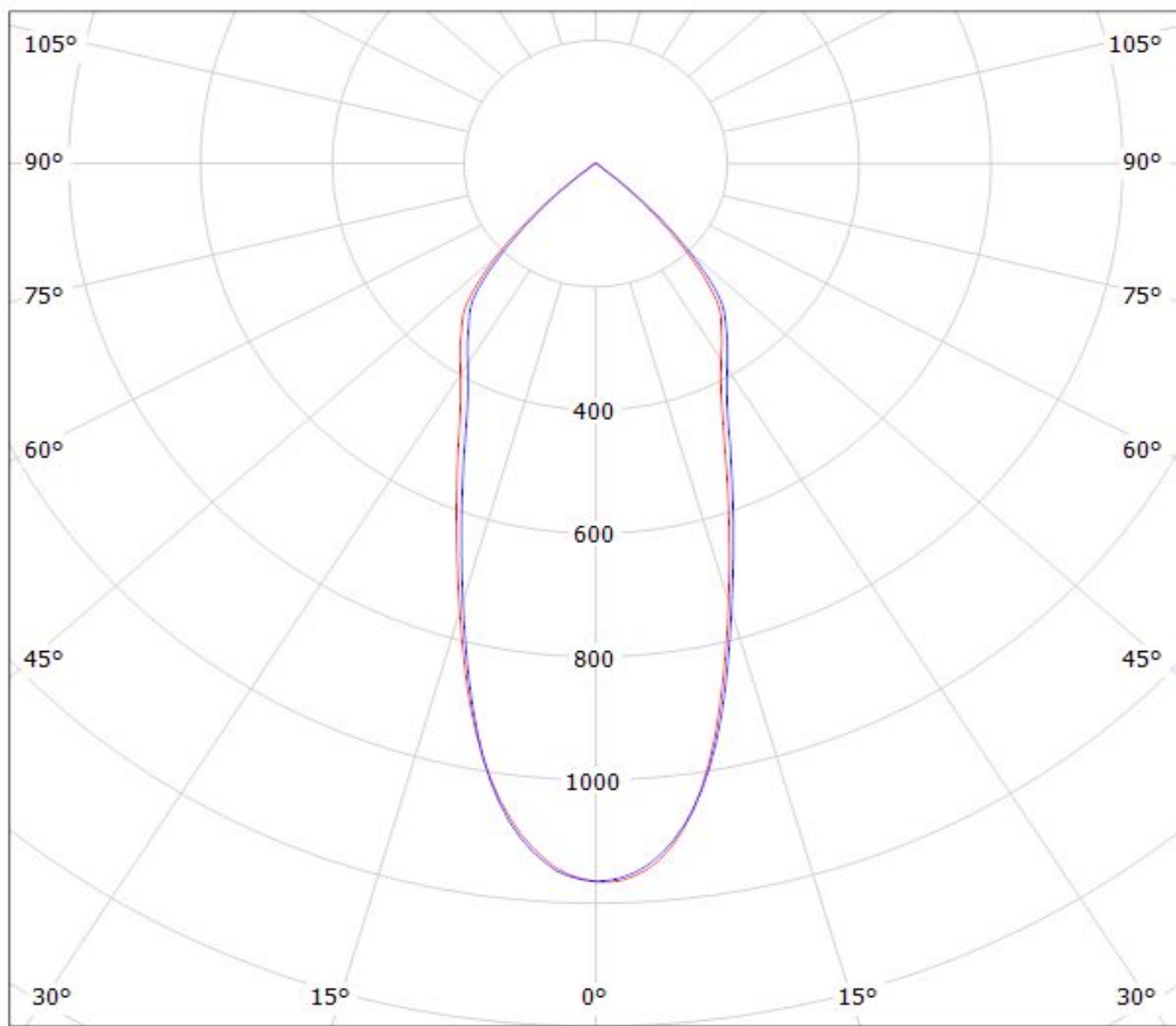

cd/klm

$\eta = 93\%$

— C0 - C180

— C90 - C270

Luminaire: LEDiL Oy F13401_ANGELINA-M_(SLE GEN4 LES19)

Lamps: 1 x SLE GEN4 LES19_1226.28lm@250mA_P=8.21367W_I=0.2498A

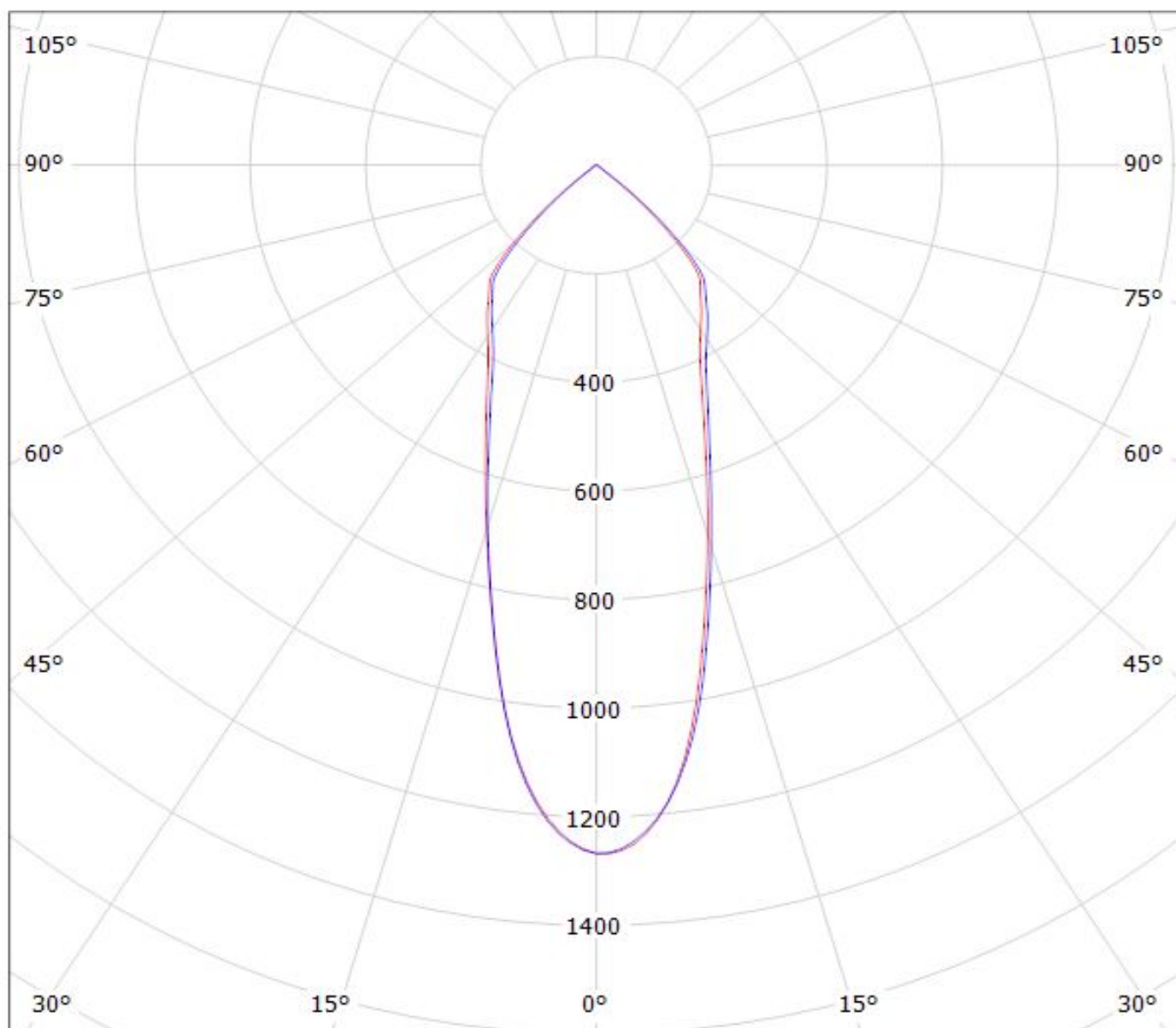

cd/klm

$\eta = 89\%$

— C0 - C180

— C90 - C270

Luminaire: LEDiL Oy F13401_ANGELINA-M_(SLE-G5_LES-15)

Lamps: 1 x Tridonic_SLE-G5_LES-15_1238lm@250mA_P=8.6575W_I=0.250A

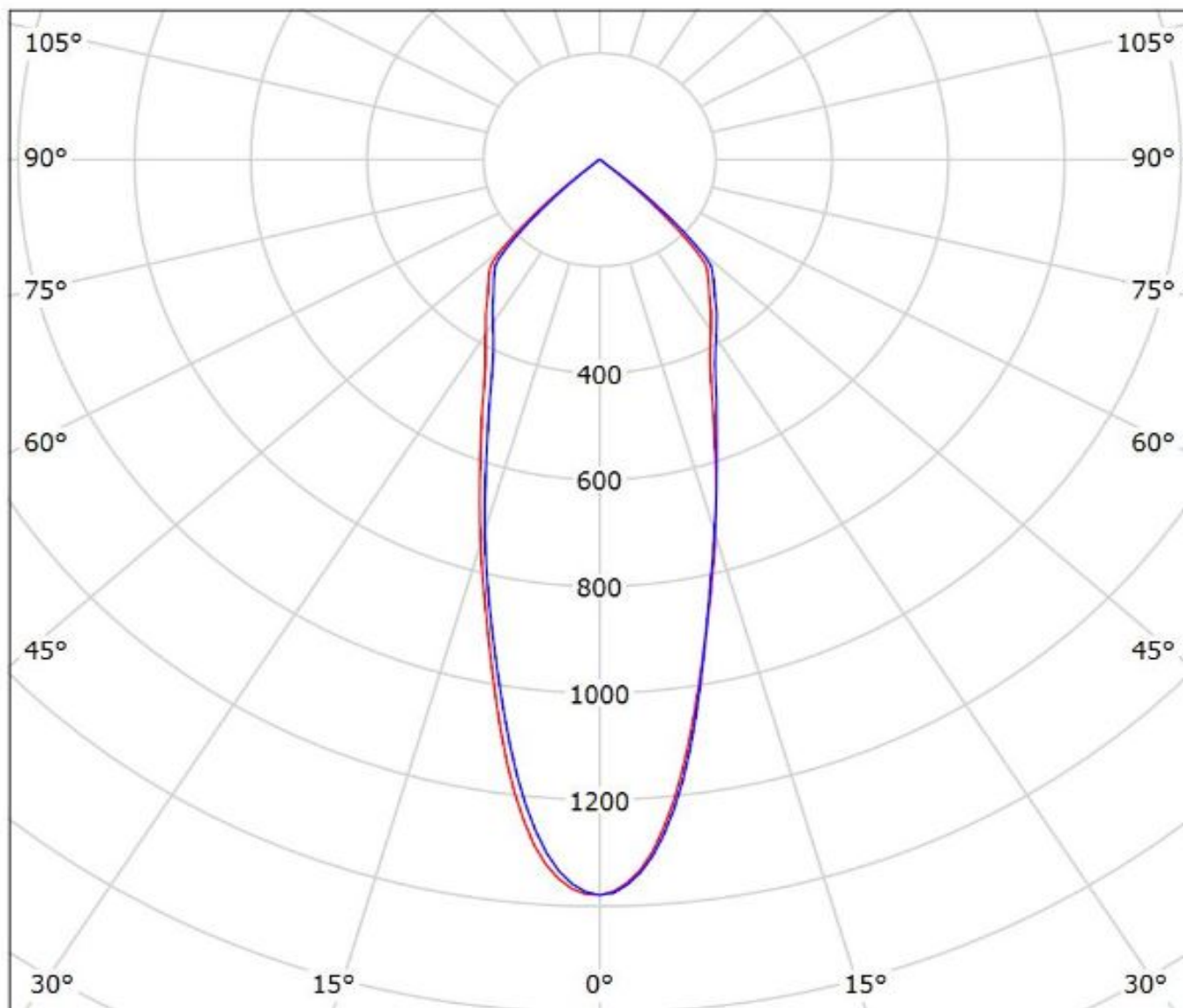

cd/klm

— C0 - C180

— C90 - C270

$\eta = 93\%$

Luminaire: LEDiL Oy F13401_ANGELINA-M_(SLE-G5_LES-19)

Lamps: 1 x Tridonic_SLE-G5_LES-19_1287.79lm@250mA_P=8.2274W_I=0.250A

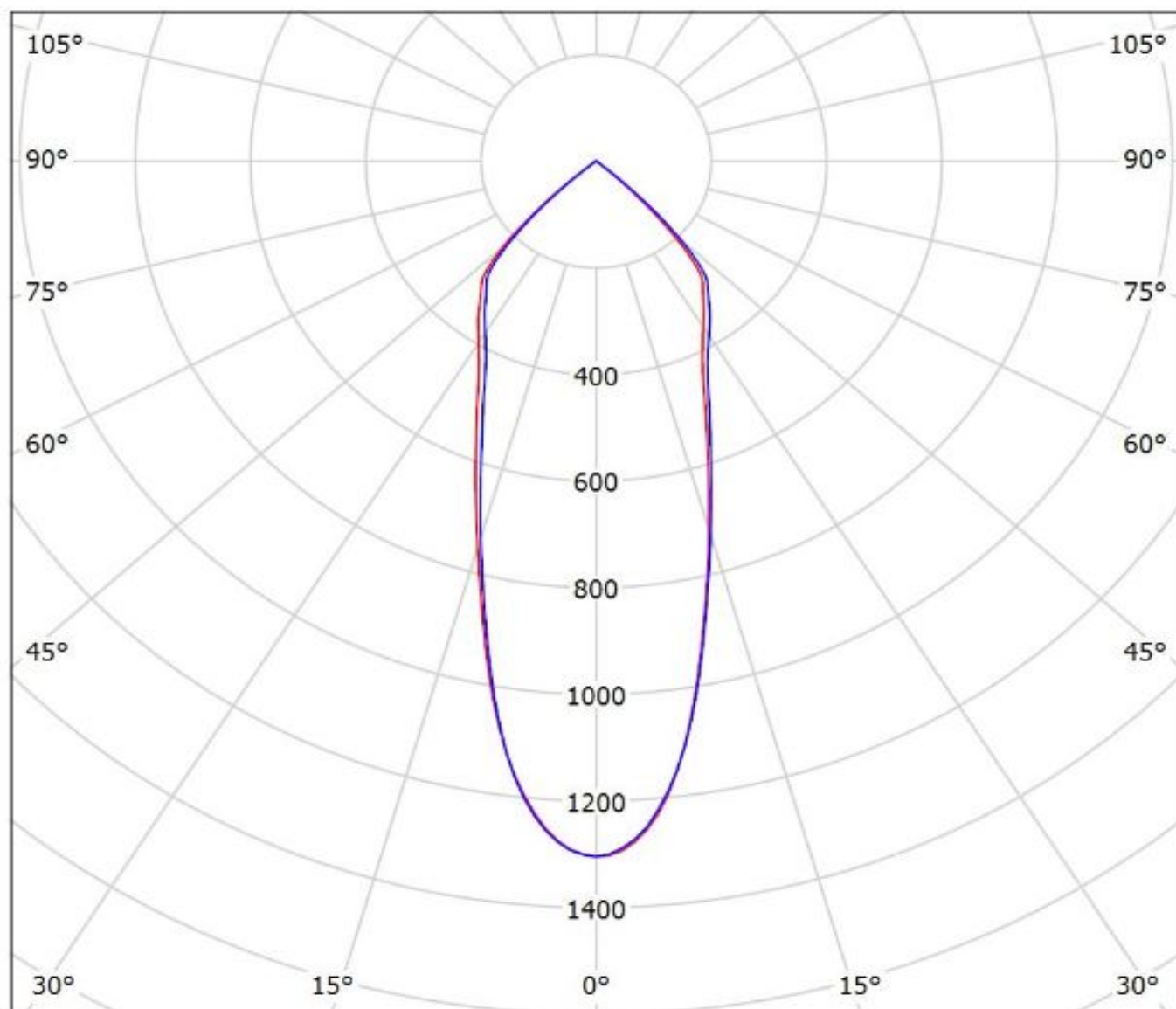

cd/klm

— C0 - C180 — C90 - C270

$\eta = 92\%$

Luminaire: LEDiL Oy F13401_ANGELINA-M_(SLE-G5_LES-23)

Lamps: 1 x Tridonic_SLE-G5_LES-23_1303.96lm@250mA_P=8.1062W_I=0.250A

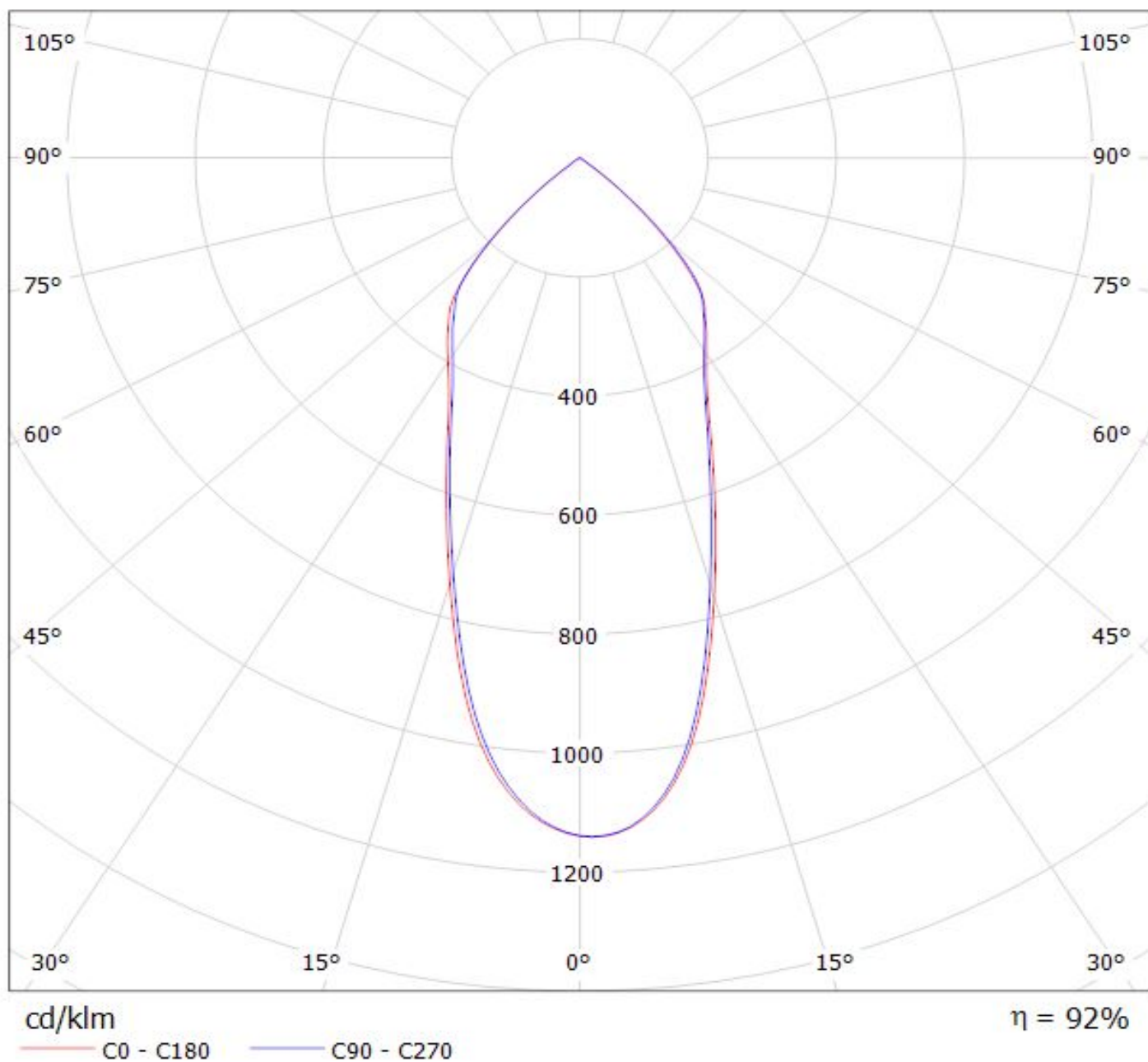

Luminaire: LEDiL Oy F13401_ANGELINA-M_(WU-M-461-827)

Lamps: 1 x Vossloh_WU-M-461-827_773.276lm@250mA_P=6.27423W_I=249.8mA

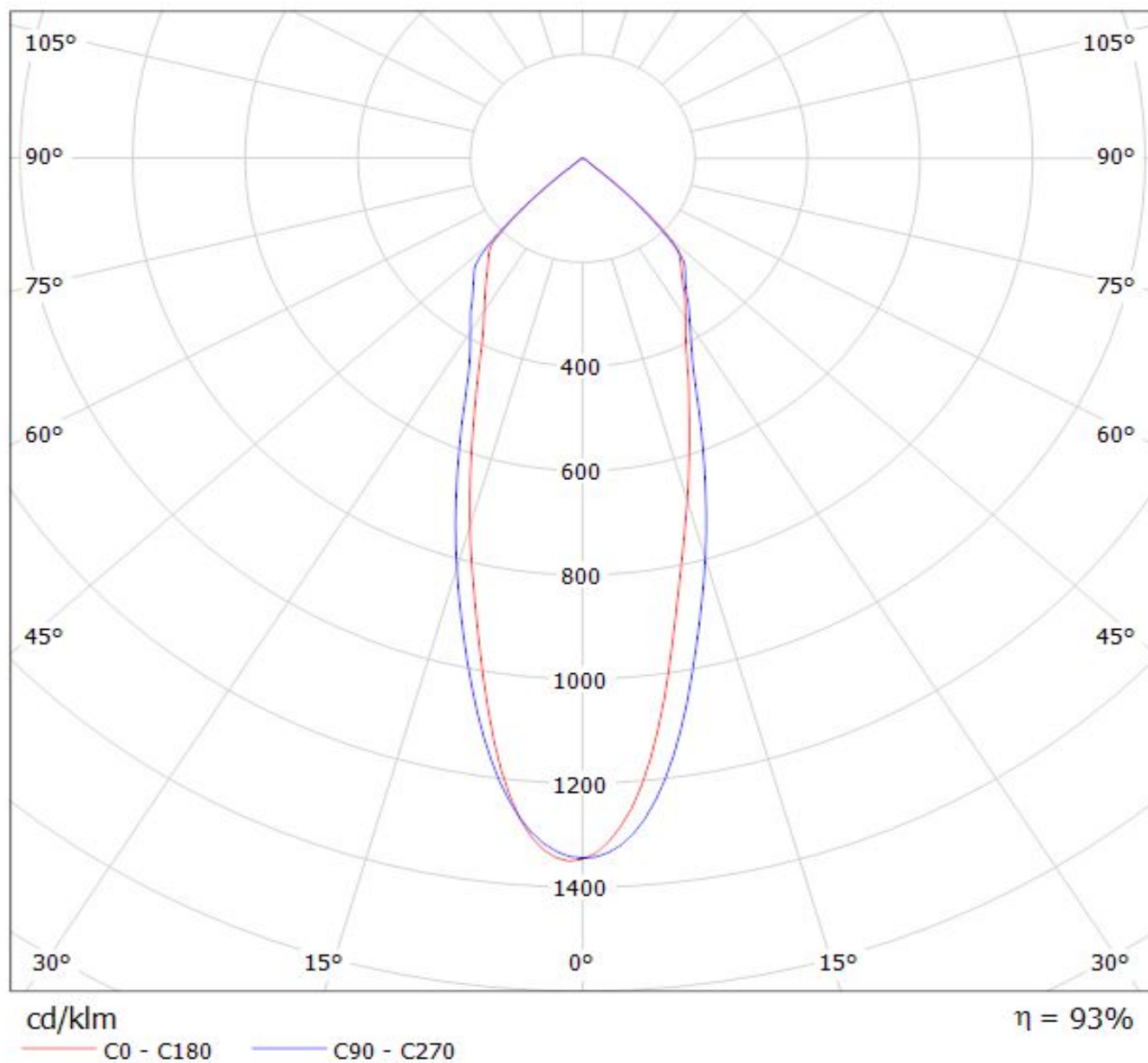

Luminaire: LEDiL Oy F13401_ANGELINA-M_(WU-M-462-827)

Lamps: 1 x Vossloh_WU-M-462-827_1116.7lm@250mA_P=8.9943W_I=249.8mA

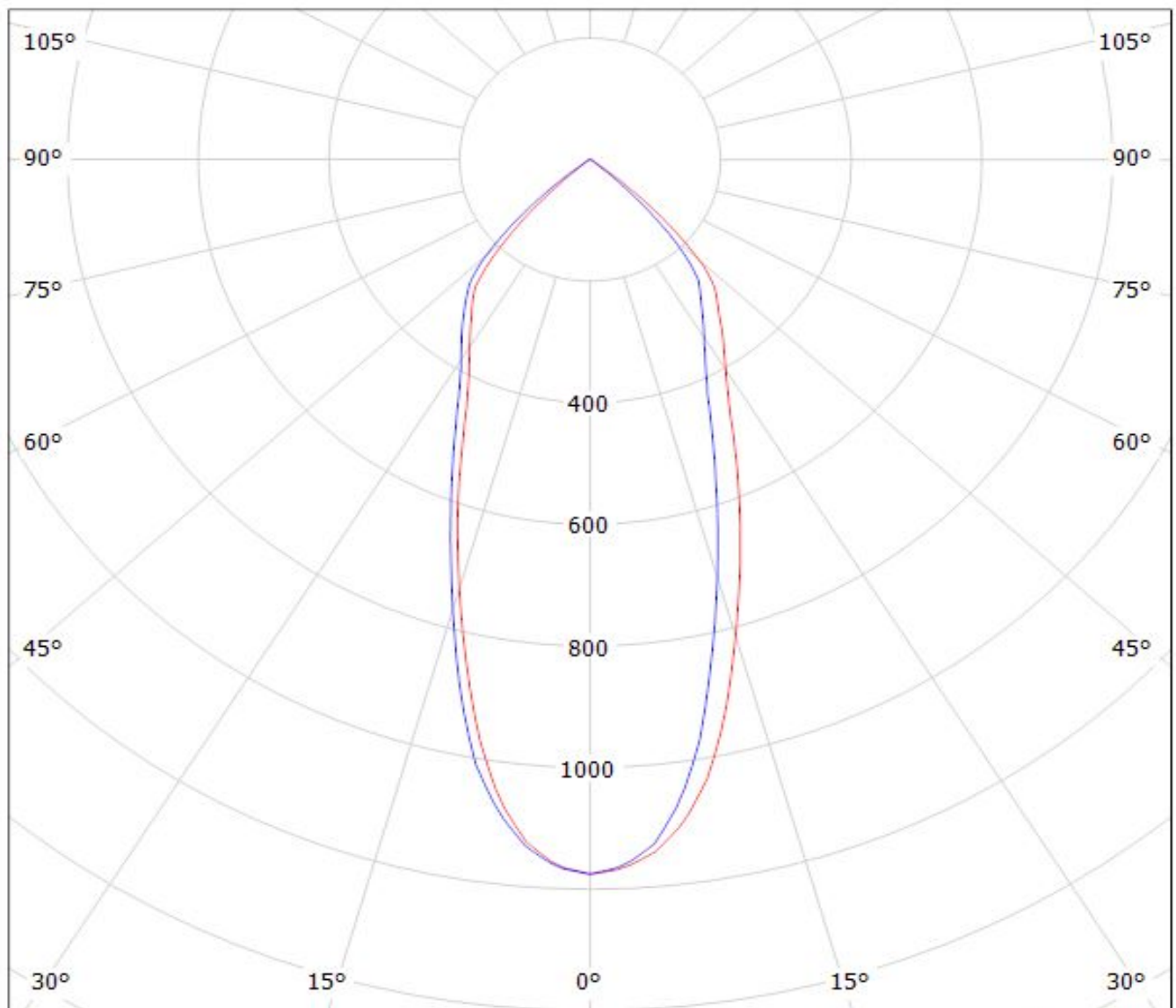

$\eta = 93\%$

cd/klm

— C0 - C180 — C90 - C270

Luminaire: LEDiL Oy F13401_ANGELINA-M_(WU-M-464-827)

Lamps: 1 x Vossloh_WU-M-464-827_1452.93lm@250mA_P=11.6939W_I=249.8mA

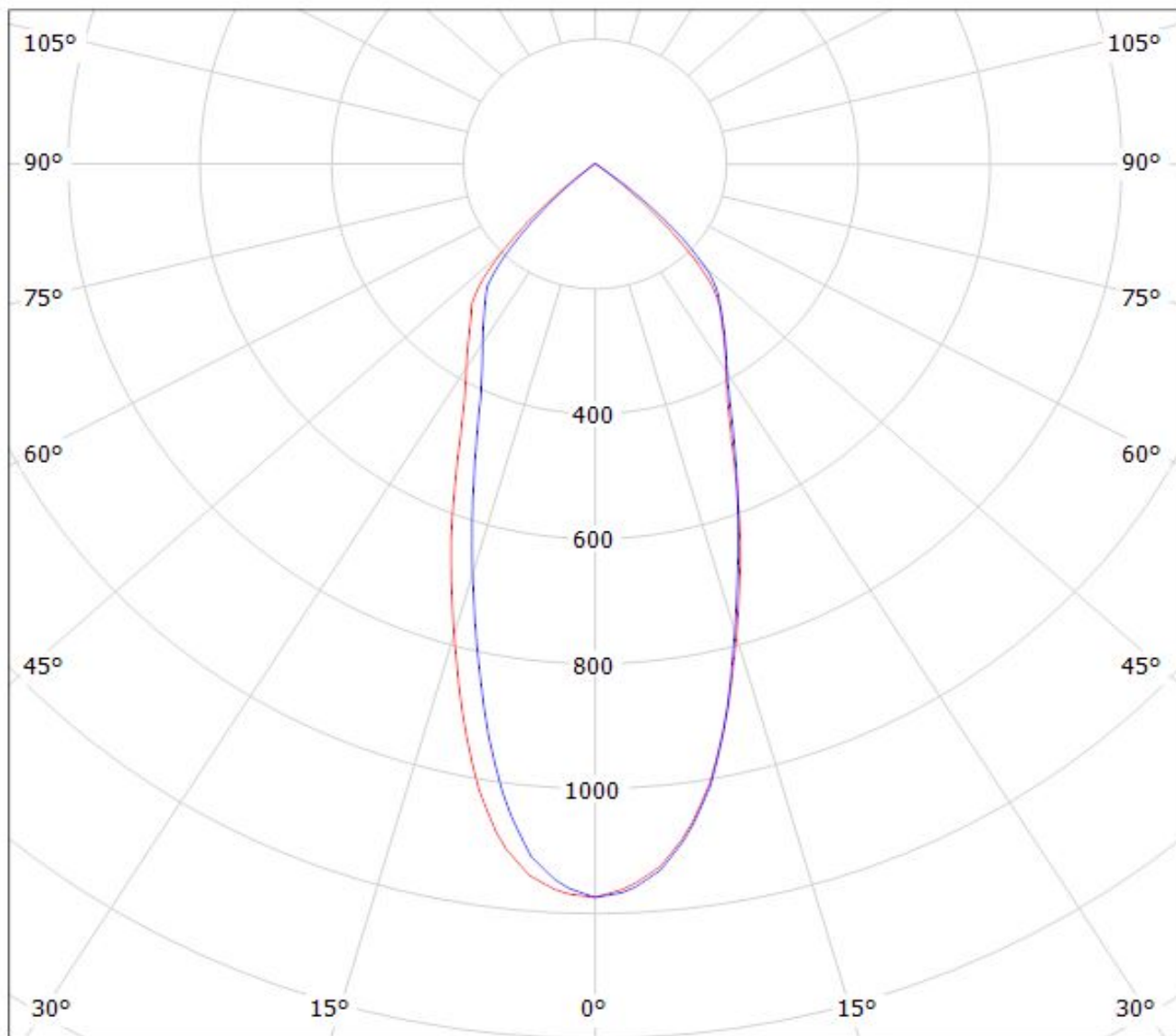

cd/klm

— C0 - C180

— C90 - C270

$\eta = 93\%$

Luminaire: LEDiL Oy F13401_ANGELINA-M_(WU-M-484)

Lamps: 1 x Vossloh_Schwabe-WU-M-484_(WU-M-484-830)_657.125lm@250mA_P=5.59976W_I=249.9mA

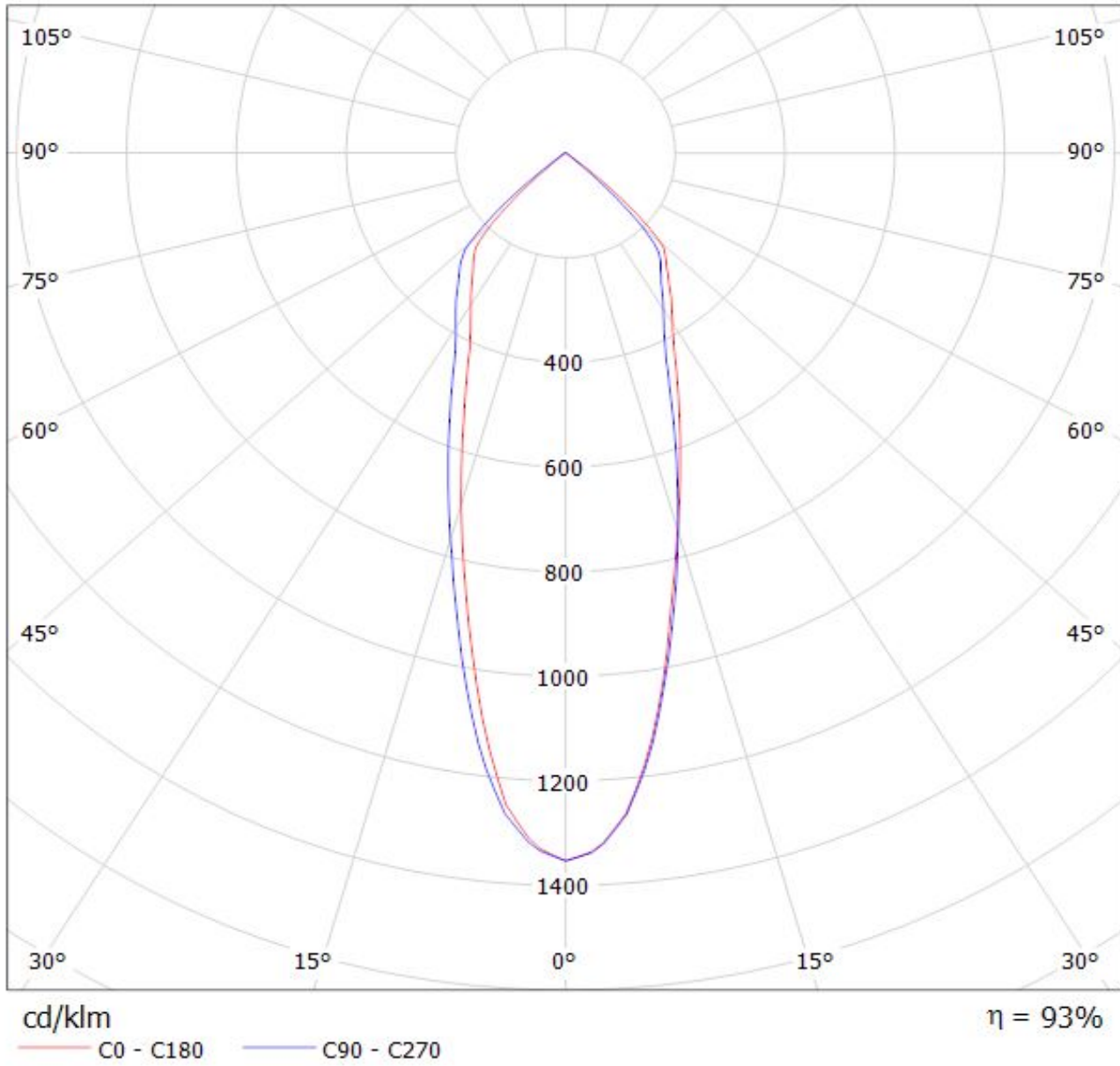

Luminaire: LEDiL Oy F13401_ANGELINA-M_(WU-M-485)

Lamps: 1 x Vossloh_Schwabe-WU-M-485_(WU-M-485-830)_1209.62lm@250mA_P=8.43849W_I=249.8mA

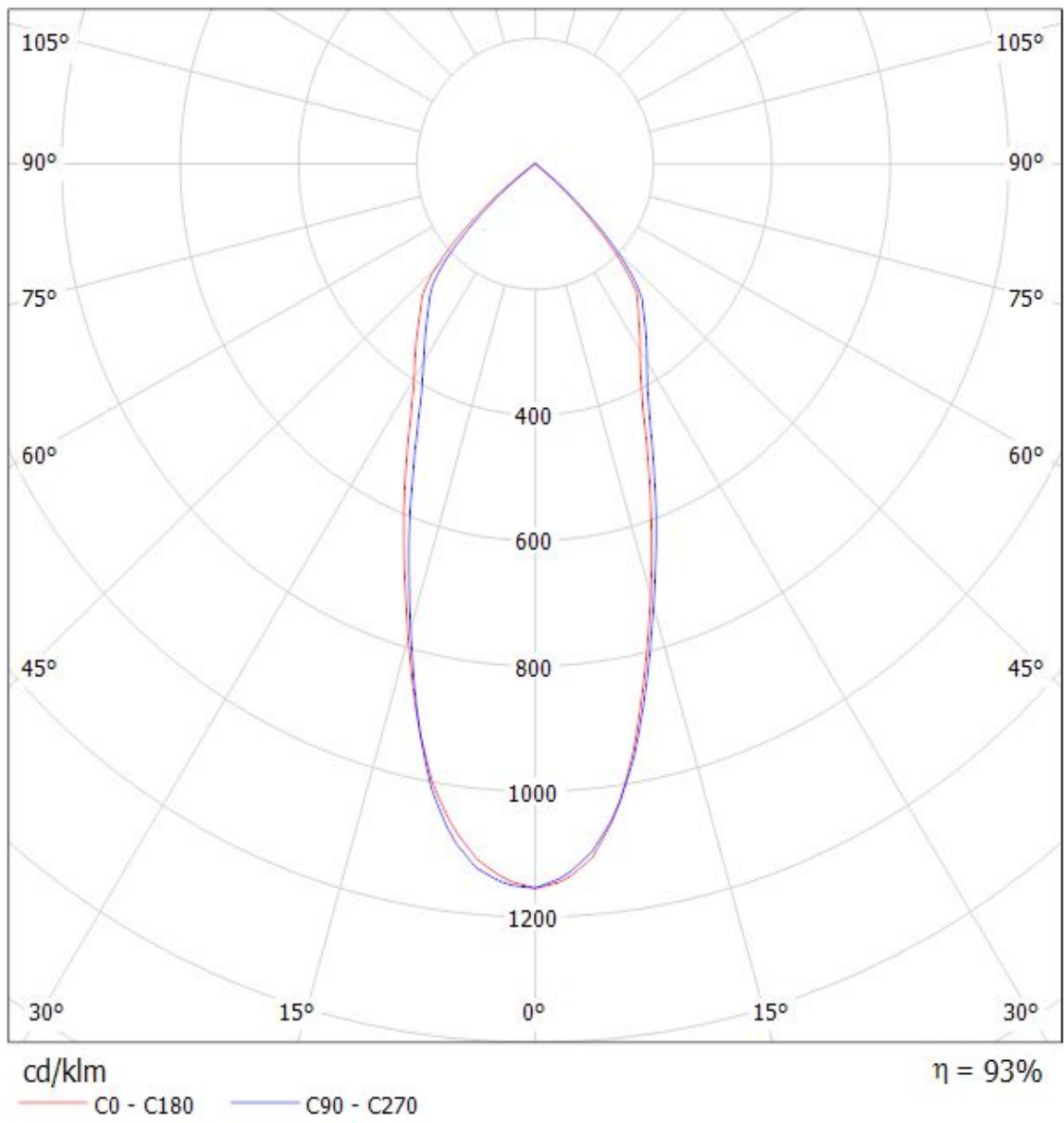

Luminaire: LEDiL Oy F13401_ANGELINA-M_(WU-M-486) Eff.92.1%
Lamps: 1 x Vossloh_Schwabe-WU-M-486_(WU-M-486-830)
_1474.55lm@250mA_P=10.4456W_I=249.8mA

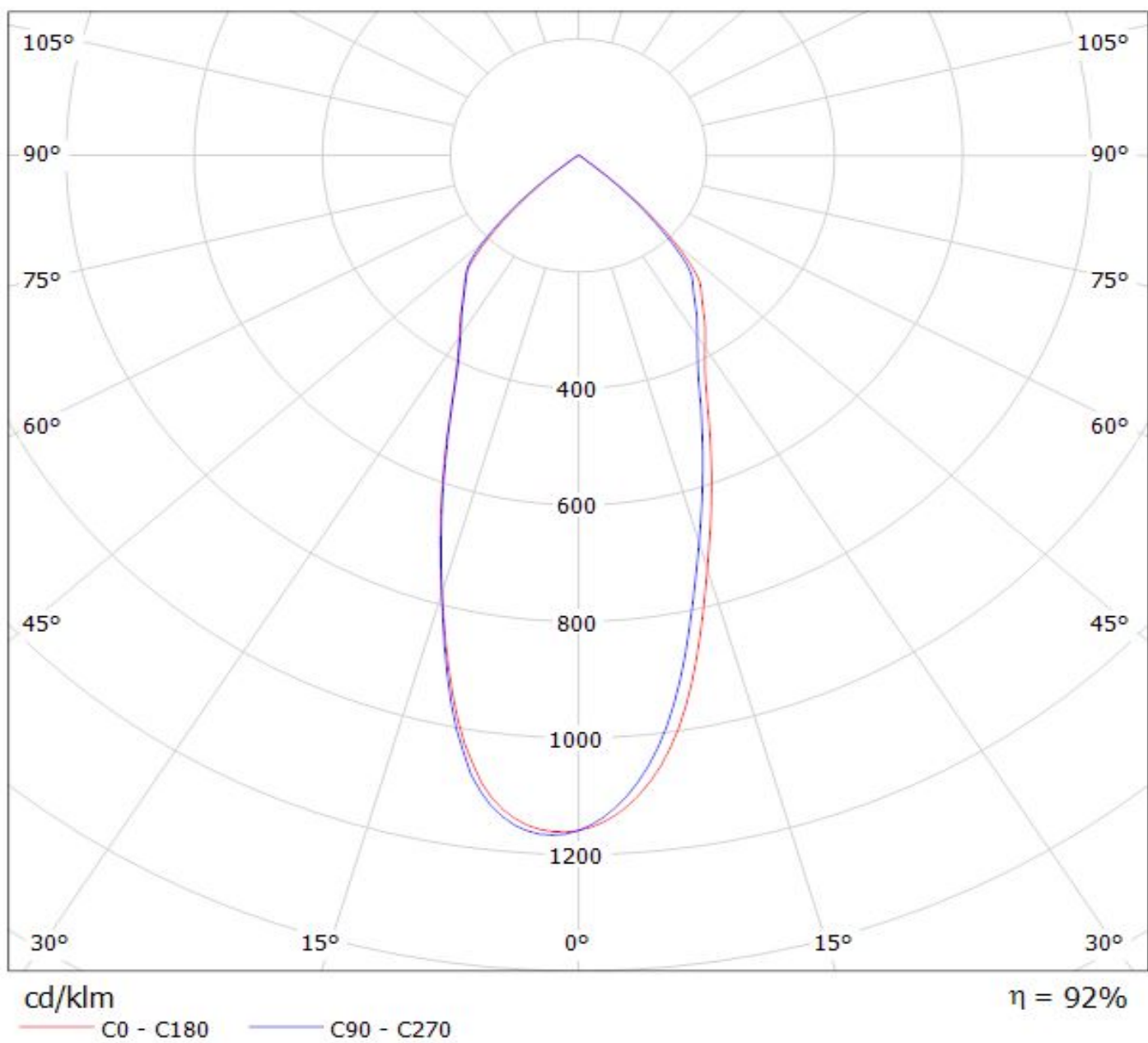

NOTE: The typical divergence will be changed by different color, chip size and chip position tolerance. The typical total divergence is the full angle measured where the luminous intensity is half of the peak value.

GENERAL INFORMATION

- Product series especially designed & optimized for series of LEDs.
- Special care taken to make light distribution as uniform as possible.

Note! Due to use of high power COB's with this product, special attention to proper thermal design is highly recommended. LEDiL has no liability for direct, indirect or consecutive damages arising from the LEDiL products being used outside of the recommended temperature range.