

Category: 固定式端子/Plug-in terminal-plug

Product name: 2555XX

Product Description: 7.5mm , 630V , 24A CE



Product Picture

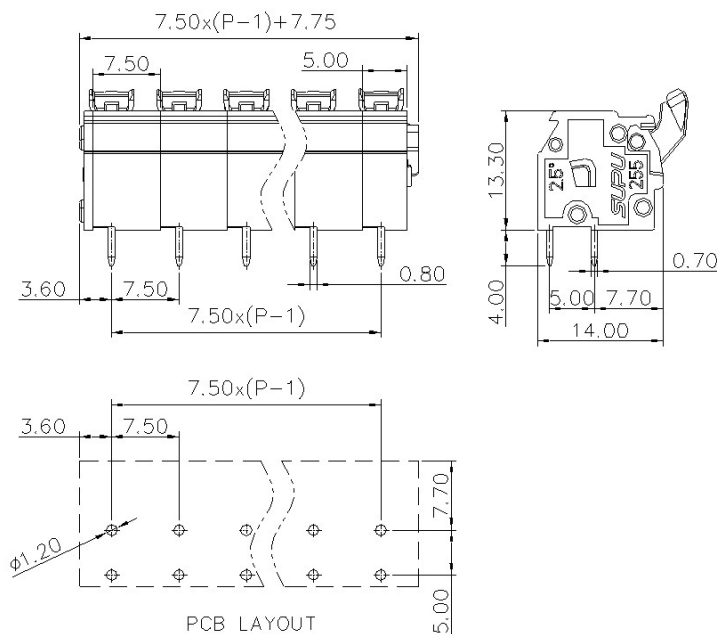

基本信息 /Basic Information

产品型号 SUPU ID	2555XX
产品间距 Pitch	7.5mm
产品层数 Number of levels	1
产品位数 Number of connections	2P-24P
接线方式 Connection method	回拉式弹簧接线Spring cage connection
防护等级 Protection Level	IP20

工作温度 Work temperature	-40~+105°C
--------------------------	------------

IEC数据 /IEC Data

额定电流 Rated Current ³²	24A		
额定电压 Rated Voltage	630V		
过压类别 Overvoltage category	III	III	II
污染等级 Pollution degree	3	2	2
额定冲击电压 Rated impulse voltage	6.0KV	6.0KV	6.0KV
额定电压 Rated Voltage	500V	630V	1000V
硬导线截面积 Conductor cross section solid	0.2-2.5mm ²		
柔性导线截面积 Conductor cross section flexible	0.2-2.5mm ²		
柔性导线截面积，带绝缘管套 Conductor cross section flexible,with furrule	0.2-2.5mm ²		
锁线螺钉规格 Locking screw Specification	-		
额定扭矩 Rated Torque	-		
固定螺钉规格 Fixed Screw Specification	-		
额定扭矩 Rated Torque	-		
剥线长度 Stripping length	5-6mm		

UL数据 /UL Data

使用组别 Use group	B	C	D
额定电流 Rated Current	15A	-	10A
额定电压 Rated Voltage	300V	-	300V

额定接线容量 Rated cross section	24-14AWG
-------------------------------	----------

材料信息 /Material Data

绝缘材料 Insulation material	PA66
绝缘材料组别 Insulation material group	I
阻燃等级，符合UL94 Flame retardant grade, UL94 compliance	V0
导体材料 Contact material	Copper alloy
导体表面镀层 Surface characteristics	Sn,Plated

产品认证 /Product Certification

认证图标
Certificate



UL证书号
UL file No.

VDE证书号
VDE No.

TUV证书号
TUV No.

Ningbo Supu Electronics Co.,Ltd

Zip code: 315303

Fax: +86 574-63288170

E-mail : askme@supu.cn

Address: No. 625, Kandun Town Street, Cixi
City, Zhejiang Province

Switchboard: +86 574-63288158

E-mail : askme@supu.cn

Service Hotline: 400-626-6336



Code