



# Disea Electronics Co., LTD

E-mail: [sales@diseaelec.com](mailto:sales@diseaelec.com) URL: [www.diseaelec.com](http://www.diseaelec.com)  
 ADD: 4F,#3 Building, TianFuAn Industrial park, LeZhuJiao, ZhouShi Road, XiXiang Town, BaoAn District, ShenZhen City, GuangDong Province, China

## PRODUCT SPECIFICATIONS

For Customer: \_\_\_\_\_

: APPROVAL FOR SPECIFICATION

Customer Model No. \_\_\_\_\_

: APPROVAL FOR SAMPLE

Module No.: ZW-T070QWH-103CP

Date : 2024.2.1

### Table of Contents

No.	Item	Page
1	Cover Sheet(Table of Contents)	P1
2	Revision Record	P2
3	General Specifications	P3
4	Outline Drawing	P4
5	DC Characteristics	P5
6	Electrical Specifications	P6-P11
7	Optical Characteristics	P12-P15
8	Reliability Test Items and Criteria	P16
9	Precautions for Use of LCD Modules	P17-P18

### For Customer's Acceptance:

Approved By	Comment

PREPARED	CHECKED	APPROVER
Ned		

**2. Revision Record**

Date	Rev.No.	Page	Revision Items	Prepared
2024.2.1	V0		The first release	Ned



## 3. General Specifications

ZW-T070QWH-103 is a TFT-LCD module. It is composed of a TFT-LCD panel, driver IC, FPC, a back light. The 7.0'' display area contains 800 x (RGB) x480 pixels and can display up to 16.7M colors. This product accords with ROHS environmental criterion.

Item	Contents	Unit	Note
LCD Type	TFT	-	
Display color	16.7M	color	1
Viewing Direction	12	O'Clock	
Gray scale direction	6	O'Clock	
Operating temperature	-20~+70	°C	
Storage temperature	-30~+80	°C	
Module size	165.00X100X5.70	mm	
Active Area(W×H)	154.08X85.92	mm	
Number of Dots	800×480	dots	
Controller	HX8664B/HX8264E	-	
Power Supply Voltage	3.3	V	
Backlight	3S10P-LEDs	pcs	
Weight	---	g	
Interface	RGB888	-	

Note 1: Color tune is slightly changed by temperature and driving voltage.

Note 2: Without FPC and Solder. With CTP

## 4.Outline.Drawing

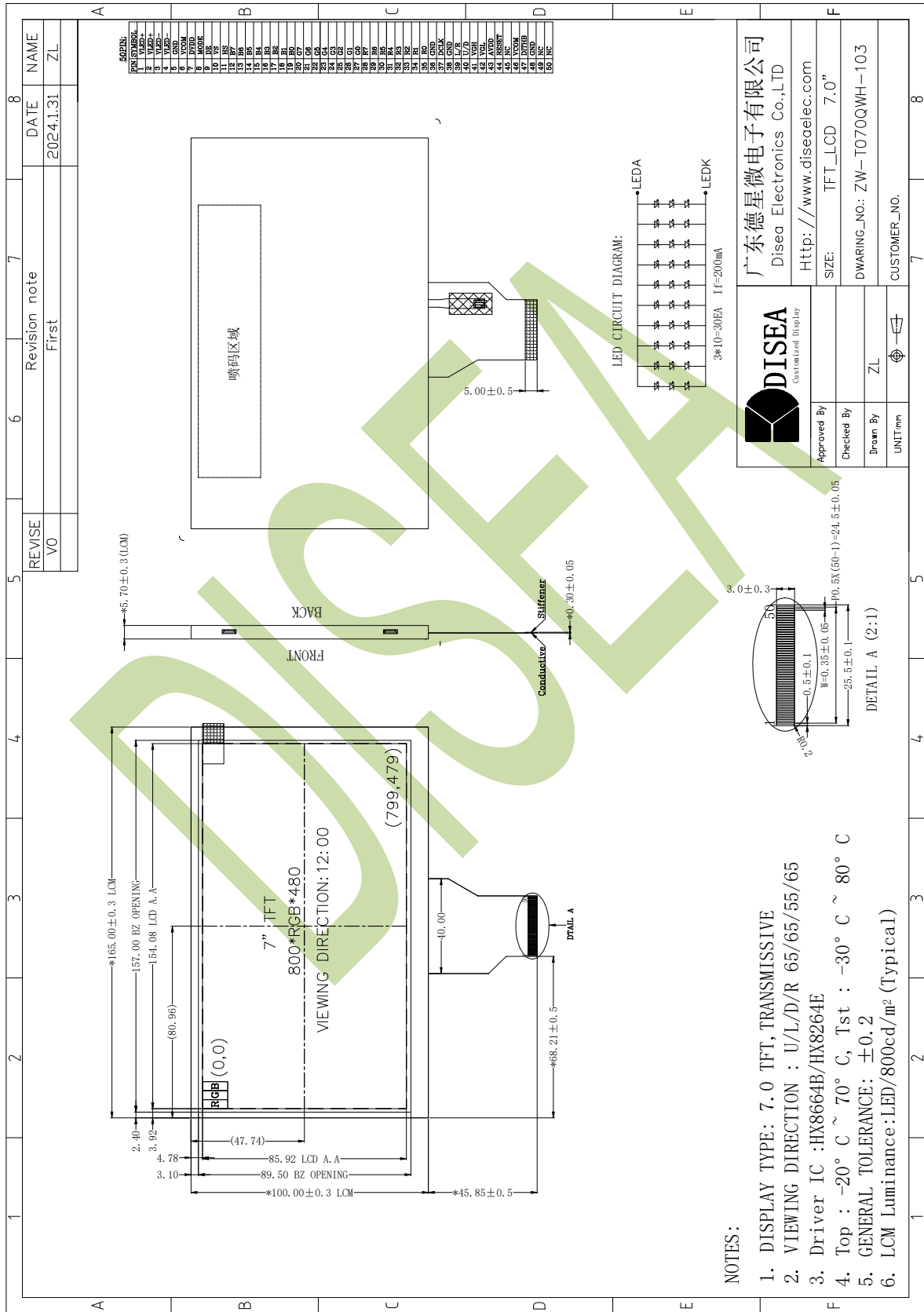

## 5. DC Characteristics

### 5.1 Electrical Absolute Maximum Ratings.( $V_{SS}=0V, T_a=25^\circ C$ )

Item	Symbol	Min.	Max.	Unit	Note
Power Supply Voltage	VDD	-0.5	5.0	V	1, 2
	AVDD	-0.5	15	V	

Notes:

1. If the module is above these absolute maximum ratings. It may become permanently damaged. Using the module within the following electrical characteristic conditions are also exceeded, the module will malfunction and cause poor reliability.
2.  $D_{VDD} > V_{SS}$  must be maintained.
3. Please be sure users are grounded when handling LCD Module.

### 5.2 Environmental Absolute Maximum Ratings.

Item	Storage		Operating		Note
	MIN.	MAX.	MIN.	MAX.	
Ambient Temperature	-30°C	80°C	-20°C	70°C	1,2
Humidity	-	-	-	-	3

Notes:

1. The response time will become lower when operated at low temperature.
2. Background color changes slightly depending on ambient temperature.  
The phenomenon is reversible.
3.  $T_a \leq 40^\circ C$ : 85%RH MAX.  
 $T_a > 40^\circ C$ : Absolute humidity must be lower than the humidity of 85%RH at  $40^\circ C$ .

## 6. Electrical Specifications

### 6.1 Electrical characteristics ( $V_{SS}=0V, T_a=25^\circ C$ )

Parameter	Symbol	Condition	Min	Typ	Max	Unit	Note
Power supply	VDD	$T_a=25^\circ C$	2.7	3.3	3.6	V	
	AVDD	$T_a=25^\circ C$	6.5	10.4	13.5	V	
	VGH	$T_a=25^\circ C$	14.5	15.0	15.5	V	
	VGL	$T_a=25^\circ C$	-10.5	-10.0	-9.5	V	
Input signal voltage	VCOM	$T_a=25^\circ C$	3.54	4.04	4.54	V	
Input voltage	'H'	$V_{IH}$	$VDD=3.3V$	$0.7*VDD$	-	VDD	V
	'L'	$V_{IL}$	$VDD=3.3V$	0	-	$0.3*VDD$	V

### 6.2 LED backlight specification ( $V_{SS}=0V, T_a=25^\circ C$ )

Item	Symbol	Condition	Min	Typ	Max	Unit	Note
Supply voltage	$V_f$	$I_f=200mA$	8.1	9.0	9.9	V	
Uniformity	$\Delta B_p$	$I_f=200mA$	75	80	-	%	
Life Time	time	$I_f=200mA$	20K	-	-	hours	1

Note 1: Brightness to be decreased to 50% of the initial value at ambient temperature  $T_a=25^\circ C$

## 6.3 Interface signals

Pin No.	Symbol	I/O	Function
1-2	VLED+	P	LED back light(Anode)
3-4	VLED-	P	LED back light(Cathode)
5	GND	P	Ground.
6	VCOM	P	Commom voltage
7	DVDD	P	Power supply
8	MODE	I	DE/YSNC mode select
9	DE	I	Data enable pin
10	VS	I	Frame sync signal
11	HS	I	Line sync signal
12-19	B7~B0	I	Blue data bus
20-27	G7~G0	I	Green data bus
28-35	R7~R0	I	Red data bus
36	GND	P	Ground.
37	DCLK	I	Data clock
38	GND	P	Ground.
39	L/R	I	Right/Left sequence control of source driver
40	U/D	I	Gate driver Up/Down scan control of gate driver
41	VGH	P	Gate on voltage
42	VGL	P	Gate off voltage
43	AVDD	P	power for analog circuit
44	RESET	I	Reset the display
45	NC	-	No connection.
46	VCOM	P	Commom voltage
47	DITHB	I	Dithering function enable control. Normally pull high. DITHB=1, enable disable internal dithering function. DITHB =0,disable internal dithering function.
48	GND	P	Ground
49-50	NC	-	No connection.

## 6.4 Timing Chart

### •Horizontal input timing

Parameter	Symbol	Spec.			Unit
		Min.	Typ.	Max.	
Horizontal Display Area	thd	-	800		DCLK
DCLK frequency	fclk	-	33.3	50	MHz
One Horizontal Line	th	862	1056	1200	DCLK
HS pulse width (Min.)	thpw		1		DCLK
HS pulse width (Typical.)	thpw		-		DCLK
HS pulse width (Max.)	thpw		40		DCLK
HS Back Porch (Blanking)	thb	46	46	46	DCLK
HS Front Porch	thfp	16	210	354	DCLK
DE mode Blanking	th-thd	45	256	400	DCLK

### •Vertical input timing

Parameter	Symbol	Spec.			Unit
		Min.	Typ.	Max.	
Vertical Display Area	tvd		480		TH
VS period time	tv	510	525	650	TH
VS pulse width	tvpw	1	-	20	TH
VS Back Porch (Blanking)	tvb	23	23	23	TH
VS Front Porch	tvfp	7	22	147	TH
DE mode Blanking	tv-tvd	4	45	170	TH



## 6.5 AC Characteristics

Parameter	Symbol	Spec.			Unit
		Min.	Typ.	Max.	
HS setup time	Thst	8	-	-	ns
HS hold time	Thhd	8	-	-	ns
VS setup time	Tvst	8	-	-	ns
VS hold time	Tvhd	8	-	-	ns
Data setup time	Tdsu	8	-	-	ns
Data hold time	Tdhd	8	-	-	ns
DE setup time	Tesu	8	-	-	ns
DE hold time	Tehd	8	-	-	ns
VDD Power On Slew rate	TPOR	-	-	20	ms
RSTB pulse width	TRst	10	-	-	μs
CLKIN cycle time	Tcph	20	-	-	ns
CLKIN pulse duty	Tcwh	40	50	60	%
Output stable time	Tsst	-	-	6	μs

### 6.5.1 parallel 24-bit RGB mode

Parameter	Symbol	Spec.			Unit	Conditions
		Min.	Typ.	Max.		
CLKIN Frequency	Fclk	-	40	50	MHz	VDD = 3.0V ~ 3.6V
CLKIN Cycle Time	Tclk	20	25	-	ns	-
CLKIN Pulse Duty	Tcwh	40	50	60	%	Tclk
Time from HSD to Source Output	Thso	-	20	-	CLKIN	-
Time from HSD to LD	Thld	-	20	-	CLKIN	-
Time from HSD to STV	Thstv	-	2	-	CLKIN	-
Time from HSD to CKV	Thckv	-	20	-	CLKIN	-
Time from HSD to OEV	Thoev	-	4	-	CLKIN	-
LD Pulse Width	Twld	-	10	-	CLKIN	-
CKV Pulse Width	Twckv	-	66	-	CLKIN	-
OEV Pulse Width	Twoev	-	74	-	CLKIN	-

## 6.6 Data Input format

The input 4-way serial data flow is a synchronous relationship with the clock, and the corresponding timing relationship between the data and the clock.

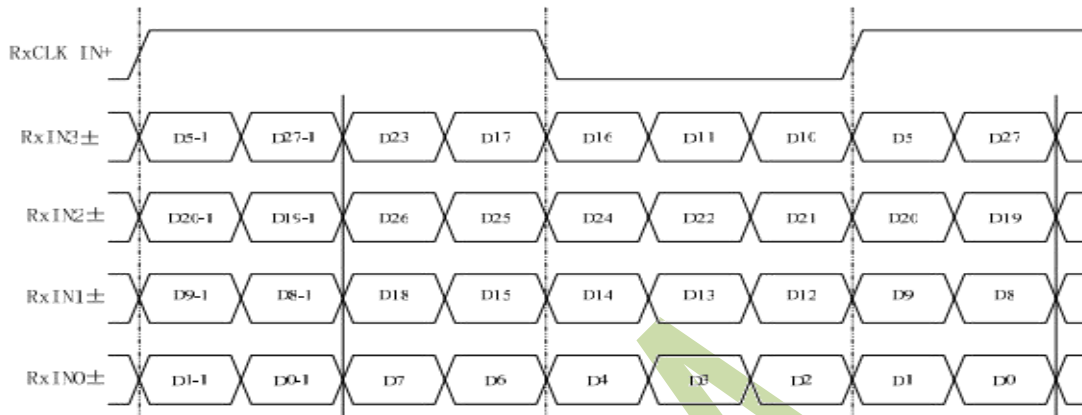

### a. Horizontal Timing

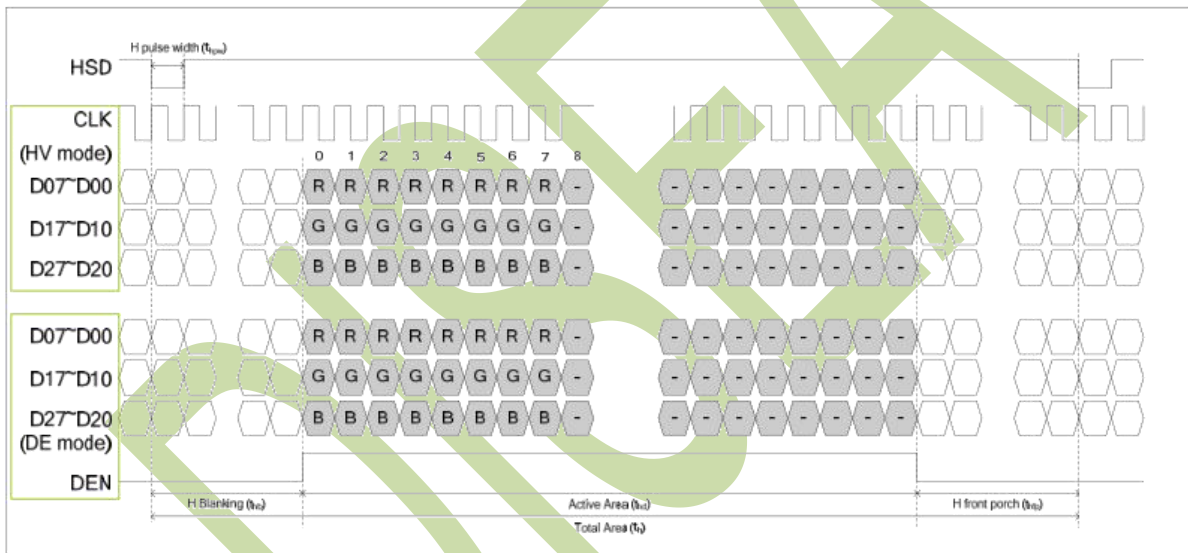

### b. Vertical Timing

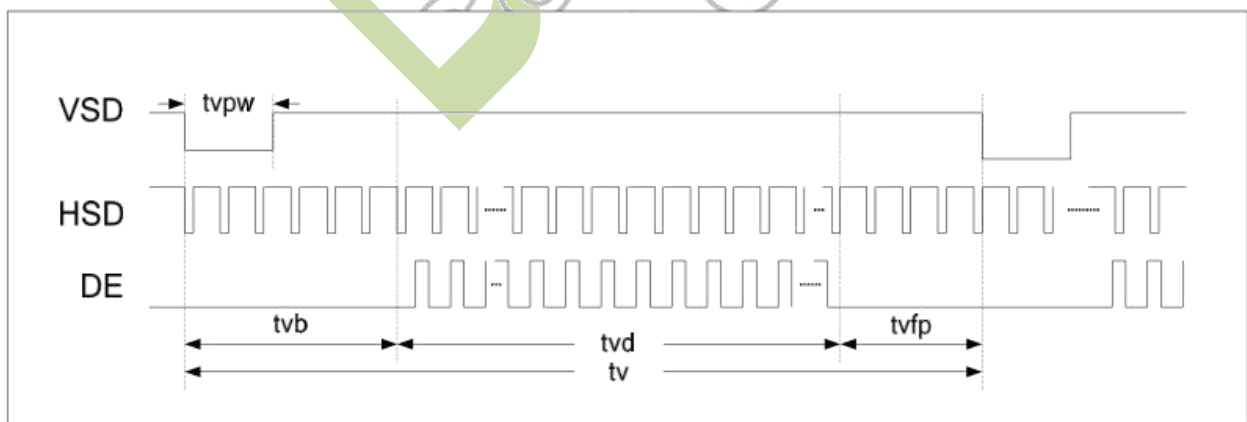



## 7. Optical Characteristics

Item	Symbol	Condition	Min.	Typ.	Max.	Unit	Note
Brightness	Bp	$\vartheta=0^\circ$ $\Phi=0^\circ$	-	800	-	Cd/m <sup>2</sup>	1
Uniformity	$\Delta$ Bp		75	80	-	%	1,2
Viewing Angle	3:00	Cr $\geq$ 10	-	65	-	Deg	3
	6:00		-	55	-		
	9:00		-	65	-		
	12:00		-	65	-		
Contrast Ratio	Cr	$\vartheta=0^\circ$ $\Phi=0^\circ$	500	800	-	-	4
Response Time	T <sub>r</sub> +T <sub>f</sub>		-	25	50	ms	5
Color of CIE Coordinate	W	x	Typ. -0.05	TBD	Typ. +0.05	-	1,6
		y				-	
	R	x				-	
		y				-	
	G	x				-	
		y				-	
	B	x				-	
		y				-	
NTSC Ratio	S		41	51	-	%	

Note: The parameter is slightly changed by temperature, driving voltage and materiel

Note 1: The data are measured after LEDs are turned on for 5 minutes. LCM displays full white. The brightness is the average value of 9 measured spots. Measurement equipment BM-7 (Φ5mm)

Measuring condition:

- Measuring surroundings: Dark room.
- Measuring temperature:  $T_a=25\text{ }^\circ\text{C}$ .
- Adjust operating voltage to get optimum contrast at the center of the display.

Measured value at the center point of LCD panel after more than 5 minutes while backlight turning on.

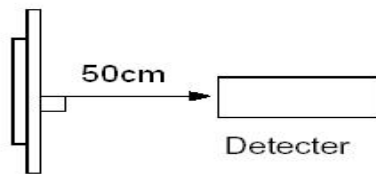

Note 2: The luminance uniformity is calculated by using following formula.

$$\Delta Bp = Bp (\text{Min.}) / Bp (\text{Max.}) \times 100 (\%)$$

$Bp (\text{Max.})$  = Maximum brightness in 9 measured spots

$Bp (\text{Min.})$  = Minimum brightness in 9 measured spots.

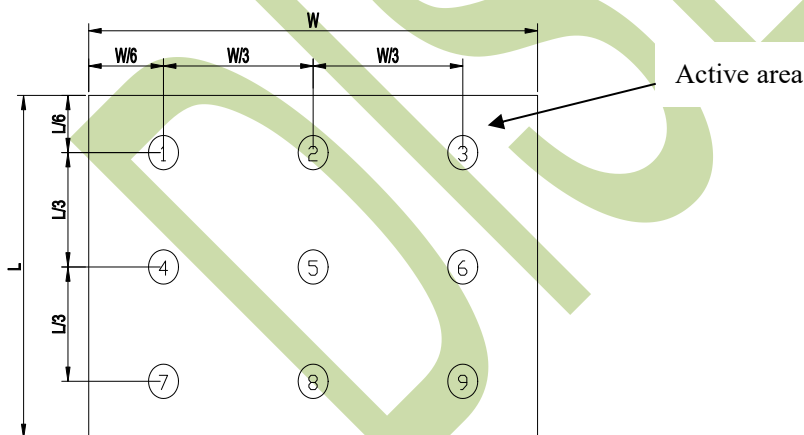

Note 3: The definition of viewing angle:

Refer to the graph below marked by  $\vartheta$  and  $\Phi$

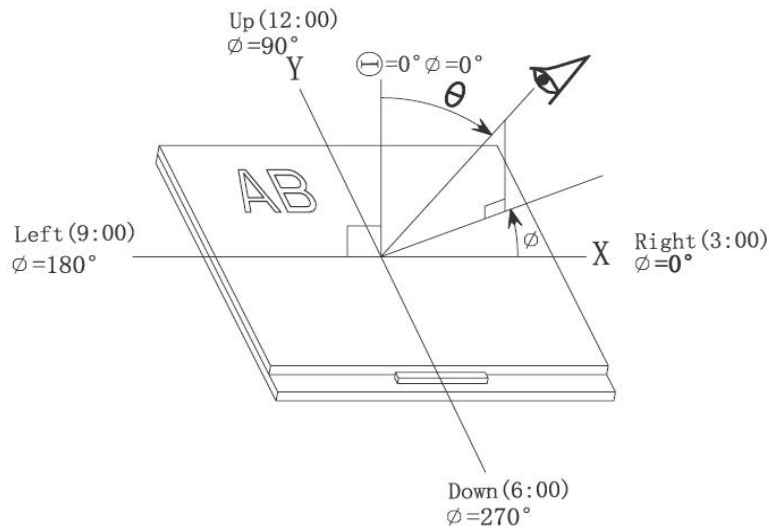

Note 4: Definition of contrast ratio.( Test LCD using DMS501)

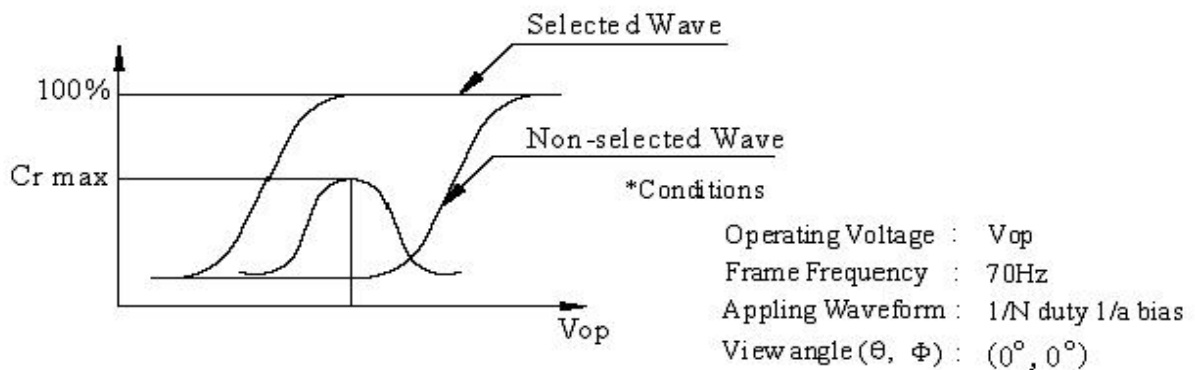

$$\text{Contrast ratio}(Cr) = \frac{\text{Brightness of selected dots}}{\text{Brightness of non-selected dots}}$$

Note 5: Definition of Response time. (Test LCD using DMS501):

The response time is defined as the LCD optical switching time interval between "White" state and "Black" state. Rise time (TON) is the time between photo detector output intensity changed from 90% to 10%. And fall time (TOFF) is the time between photo detector output intensity changed from 10% to 90%.

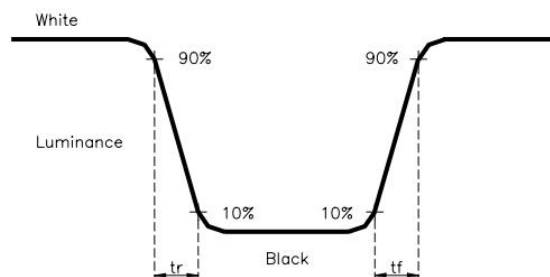

The definition of response time

Note 6: Definition of Color of CIE Coordinate and NTSC Ratio.

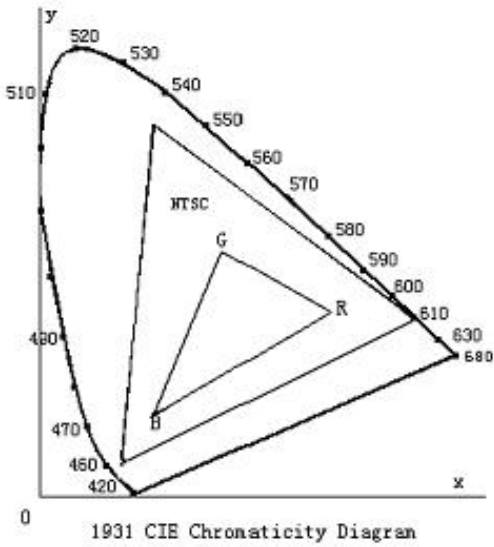

Color gamut:

$$S = \frac{\text{area of RGB triangle}}{\text{area of NTSC triangle}} \times 100\%$$

Note 7: Definition of cross talk.

$$\text{Cross talk ratio(\%)} = \frac{|\text{pattern A Brightness} - \text{pattern B Brightness}|}{\text{pattern A Brightness}} \times 100$$

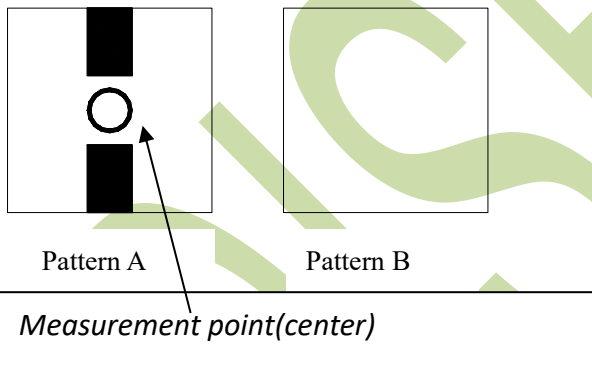

Electric volume value = 3F +/- 3Hex

## 8. Reliability Test Items and Criteria

Test Item	Test condition	Remark
High Temperature Storage	Ta = 80°C 96hrs	Note1,Note3, 4
Low Temperature Storage	Ta = -30°C 96hrs	Note1,Note3, 4
High Temperature Operation	Ta = 70°C 96hrs	Note2,Note3, 4
Low Temperature Operation	Ta = -20°C 96hrs	Note1,Note3, 4
Operation at High Temperature/Humidity	+60°C, 90%RH 96hrs	Note3, 4
Thermal Shock	-30°C/30 min ~ +80°C/30 min for a total 10 cycles, Start with cold temperature and end with high temperature.	Note3, 4

Note 1: Ta is the ambient temperature of samples.

Note 2: Ts is the temperature of panel's surface.

Note 3: In the standard condition, there shall be no practical problem that may affect the display function. After the reliability test, the product only guarantees operation, but don't guarantee all of the cosmetic specification.

Note 4: Before cosmetic and function test, the product must have enough recovery time, at least 2 hours at room temperature



## **9. Precautions for Use of LCD Modules**

### **9.1 Handling Precautions**

9.1.1 *The display panel is made of glass. Do not subject it to a mechanical shock by dropping it from a high place, etc.*

9.1.2 *If the display panel is damaged and the liquid crystal substance inside it leaks out, be sure not to get any in your mouth, if the substance comes into contact with your skin or clothes, promptly wash it off using soap and water.*

9.1.3 *Do not apply excessive force to the display surface or the adjoining areas since this may cause the color tone to vary.*

9.1.4 *The polarizer covering the display surface of the LCD module is soft and easily scratched. Handle this polarizer carefully.*

9.1.5 *If the display surface is contaminated, breathe on the surface and gently wipe it with a soft dry cloth. If still not completely clear, moisten cloth with one of the following solvents:*

- Isopropyl alcohol*
- Ethyl alcohol*

*Solvents other than those mentioned above may damage the polarizer. Especially, do not use the following:*

- Water*
- Ketone*
- Aromatic solvents*

9.1.6 *Do not attempt to disassemble the LCD Module.*

9.1.7 *If the logic circuit power is off, do not apply the input signals.*

9.1.8 *To prevent destruction of the elements by static electricity, be careful to maintain an optimum work environment.*

*a. Be sure to ground the body when handling the LCD Modules.*

*b. Tools required for assembly, such as soldering irons, must be properly ground.*

*c. To reduce the amount of static electricity generated, do not conduct assembly and other work under dry conditions.*

*d. The LCD Module is coated with a film to protect the display surface. Be care when peeling off this protective film since static electricity may be generated.*

## **9.2 Storage precautions**

9.2.1 When storing the LCD modules, avoid exposure to direct sunlight or to the light of fluorescent lamps.

9.2.2 The LCD modules should be stored under the storage temperature range. If the LCD modules will be stored for a long time, the recommend condition is:

Temperature :  $0^{\circ}\text{C} \sim 40^{\circ}\text{C}$

Relatively humidity:  $\leq 80\%$

9.2.3 The LCD modules should be stored in the room without acid, alkali and harmful gas.

**9.3 The LCD modules should be no falling and violent shocking during transportation, and also should avoid excessive press, water, damp and sunshine.**

END