

Micro Switch

Q-468

TYPE: **MSW-01A**

SPECIFICATIONS

Rating: 10A 125/250V AC
 Contact R: 20mΩ max
 Insulation R: 500V DC 100MΩ min
 Dielectric Strength: 1 Minute 1500V AC
 Operating Temperature: -25°C ~ +85°C
 Electrical Life: 100,000 Cycles

Outline Drawing

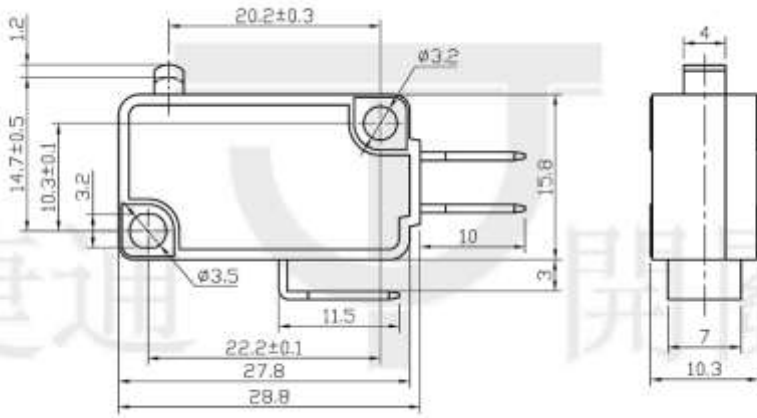

Mounting

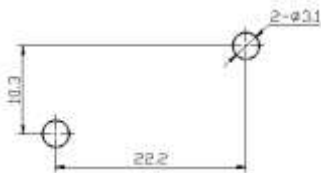

Circuitry

