

PLY10AN1121R8R2B

Discontinued **RoHS** **REACH**

Appearance & Shape

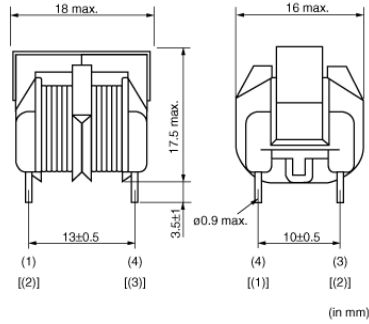

Packaging Information

Packaging	Specifications	Minimum Order Quantity
-	Box	1200

Attention

- 1.This datasheet is downloaded from the website of Murata Manufacturing Co., Ltd. Therefore, it's specifications are subject to change or our products in it may be discontinued without advance notice. Please check with our sales representatives or product engineers before ordering.
- 2.This datasheet has only typical specifications because there is no space for detailed specifications. Therefore, please review our product specifications or consult the approval sheet for product specifications before ordering.

PLY10AN1121R8R2B



Specifications

Common Mode Inductance(min.)	1.1mH
Nomal Mode Inductance(min.)	90μH
DC Resistance(max.)	0.25Ω
Rated Current	1.8A
Length	18mm max.
Width	16mm max.
Thickness	17.5mm max.
Operating Temperature Range	-25°C to 60°C
Winding Temperature Rise(at Rated Current)(max.)	60°C
Rated Voltage	300Vac
Insulation Resistance(min.)	10MΩ
Withstanding Voltage	1600V(AC)(1minute) or 2000V(AC)(2second)
Mass(typ.)	9.9g
Winding Mode	Standard Winding

Attention

- 1.This datasheet is downloaded from the website of Murata Manufacturing Co., Ltd. Therefore, it's specifications are subject to change or our products in it may be discontinued without advance notice. Please check with our sales representatives or product engineers before ordering.
- 2.This datasheet has only typical specifications because there is no space for detailed specifications.
Therefore, please review our product specifications or consult the approval sheet for product specifications before ordering.

PLY10AN1121R8R2B

Product Data

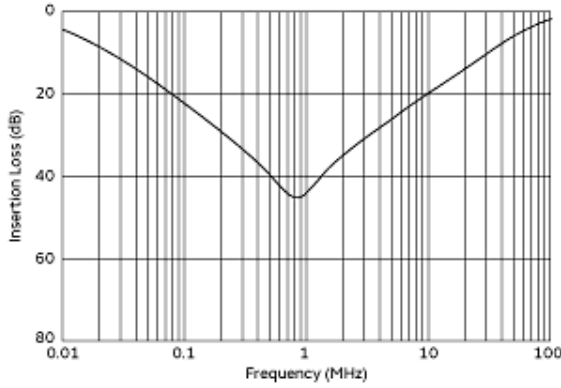

Common Mode Insertion Loss (Typ.)

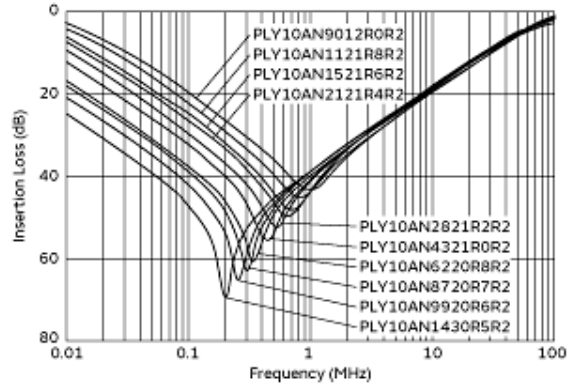

Common Mode Insertion Loss-Frequency Characteristics

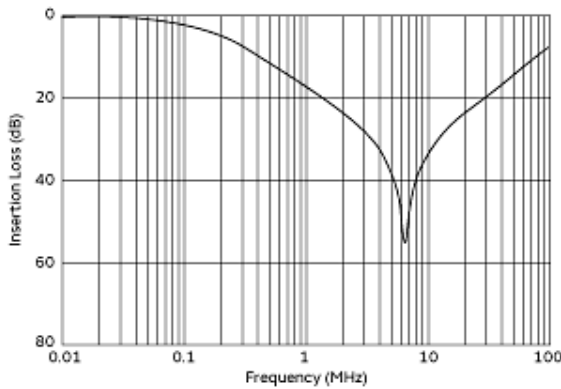

Differential Mode Insertion Loss (Typ.)

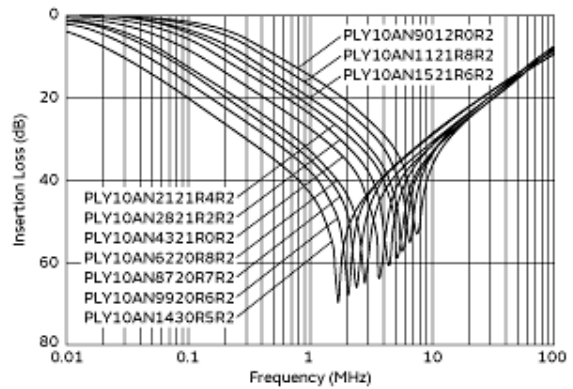

Differential Mode Insertion Loss-Frequency Characteristics

Attention

1.This datasheet is downloaded from the website of Murata Manufacturing Co., Ltd. Therefore, it's specifications are subject to change or our products in it may be discontinued without advance notice. Please check with our sales representatives or product engineers before ordering.
2.This datasheet has only typical specifications because there is no space for detailed specifications.
Therefore, please review our product specifications or consult the approval sheet for product specifications before ordering.