

PLASTIC-ENCAPSULATE VOLTAGE REGULATORS

FEATURES

- Maximum Output Current I_o : 0.5 A
- Output Voltage V_o : 5 V
- Continuous Total Dissipation
 P_D : 1.25 W ($T_a = 25\text{ }^\circ\text{C}$)
- Surface Mount device

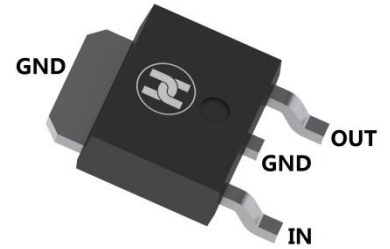

SCHEMATIC DIAGRAM

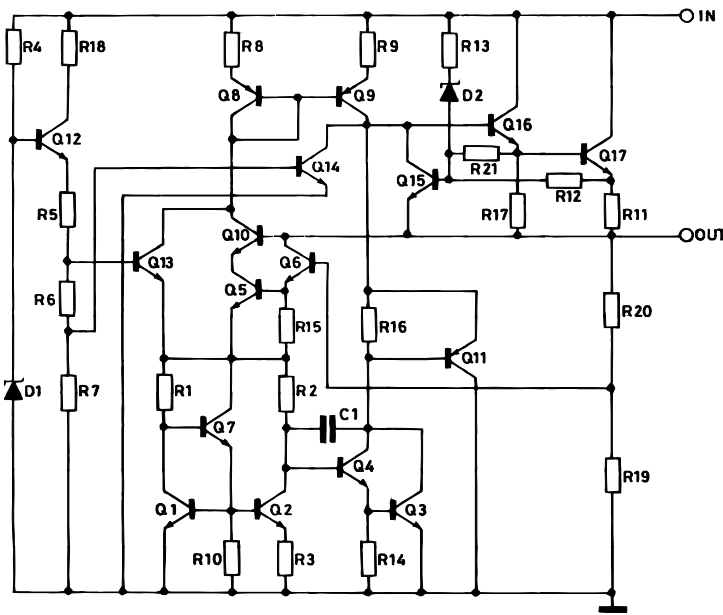

TO-252

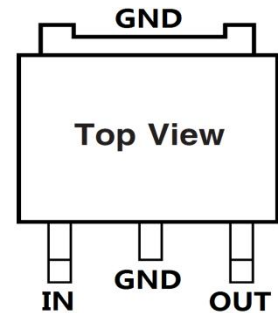

MECHANICAL DATA

- Case: TO-252
- Case Material: Molded Plastic. UL flammability
- Classification Rating: 94V-0
- Weight: 0.055 grams (approximate)
- Marking: 78M05

MAXIMUM RATINGS (Operating temperature range applies unless otherwise specified)

Parameter	Symbol	Value	Unit
Input Voltage	V_i	35	V
Power Dissipation	P_D	1250	mW
Thermal Resistance from Junction to Ambient	$R_{\theta JA}$	80	$^\circ\text{C/W}$
Operating Temperature	T_{opr}	-20~+125	$^\circ\text{C}$
Storage Temperature Range	T_{STG}	-65 ~+150	$^\circ\text{C}$

PLASTIC-ENCAPSULATE VOLTAGE REGULATORS
**ELECTRICAL CHARACTERISTICS AT SPECIFIED VIRTUAL JUNCTION TEMPERATURE
($V_i=10V, I_o=350mA, C_i=0.33\mu F, C_o=0.1\mu F$, unless otherwise specified)**

参数	符号	测试条件	最小值	典型值	最大值	单位	
输出电压	V_o	$T_A = 25^\circ C$	4.80	5.0	5.20	V	
		$5.0mA \leq I_o \leq 500mA,$ $P_o \leq 7.5W,$ $V_i = 7.5V \sim 20V$	4.75	5.0	5.25		
电压线性	ΔV_o	$T_A = 25^\circ C$	$V_i = 7.2V \sim 20V$		5	50	mV
			$V_i = 8V \sim 12V$		1.5	25	
负载线性	ΔV_o	$T_A = 25^\circ C$	$I_o = 5mA \sim 0.5A$		9	50	mV
			$I_o = 5 \sim 200mA$		4	25	
静态电流	I_Q	$T_A = 25^\circ C$		5	8	mA	
静态电流变化	ΔI_Q	$T_A = 25^\circ C$	$I_o = 5mA \sim 0.5A$			0.5	mA
			$V_i = 7.5V \sim 25V, I_o = 200mA$			0.8	
			$V_i = 8V \sim 20V,$ $T_A = 25^\circ C$			0.8	
输出电压温度系数	$\Delta V_o / \Delta T$	$I_o = 5mA$		-0.8		mV/ $^\circ C$	
输出噪声电压	V_N	$f = 10Hz \sim 100kHz,$ $T_A = 25^\circ C$		42		μV	
纹波抑制	$\Delta V_i / \Delta V_o$	$f = 120Hz, V_i = 8V \sim 18V$ $I_o = 200mA$		68		dB	
下降电压	V_{DROP}	$I_o = 0.5A, T_A = 25^\circ C$		2		V	
输出电阻	R_o	$f = 1kHz$		17		m Ω	
短路电流	I_{SC}	$V_i = 35V, T_A = 25^\circ C$		10		mA	
输出峰值电流	I_{PK}	$T_A = 25^\circ C$		0.5		A	

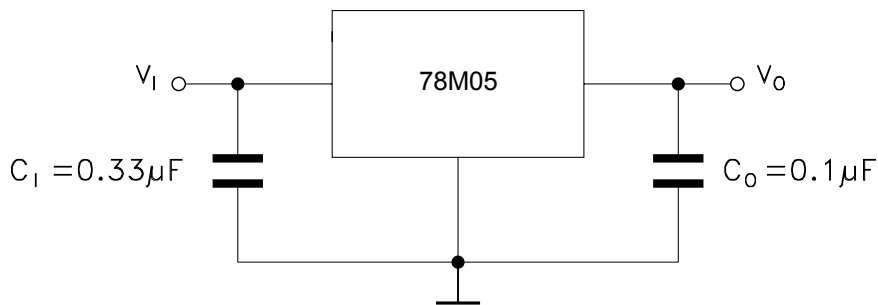
TYPICAL APPLICATION

Note: Bypass capacitors are recommended for optimum stability and transient response and should be located as close as Possible to the regulators.

PLASTIC-ENCAPSULATE VOLTAGE REGULATORS

Typical Characteristics

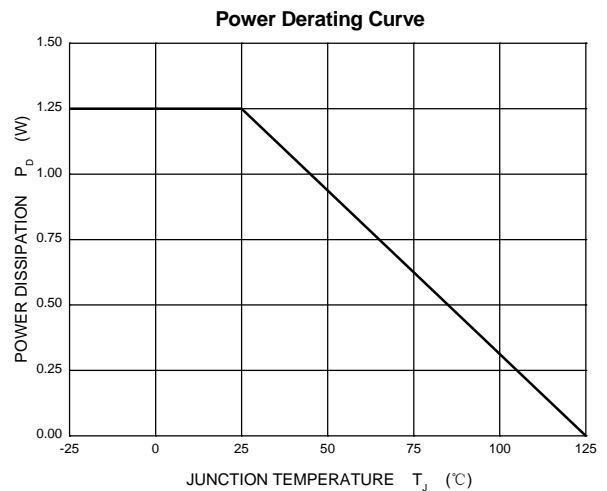
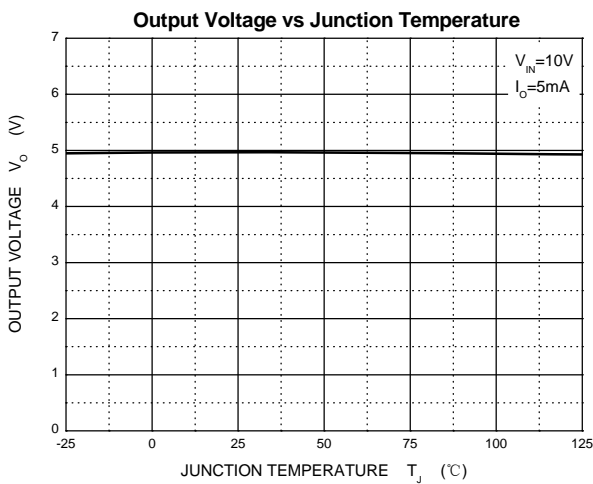
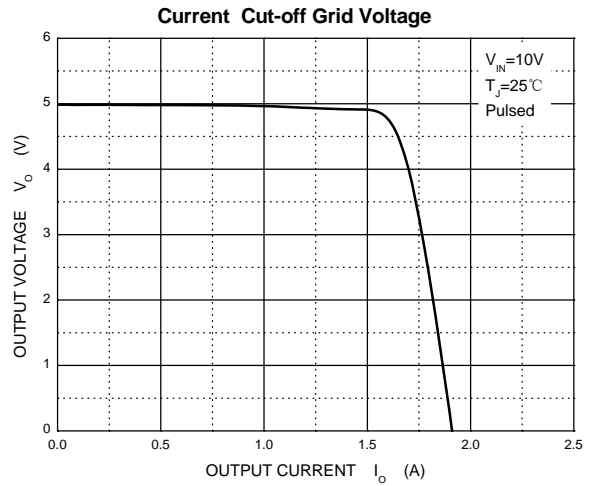
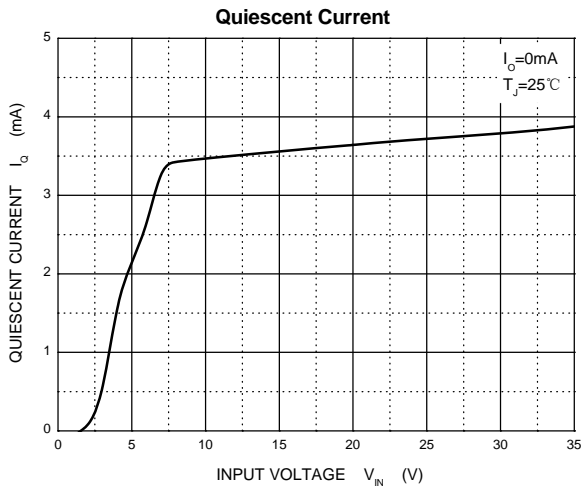
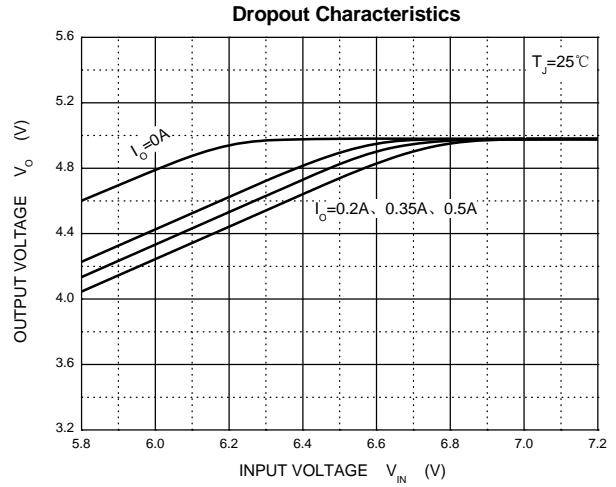
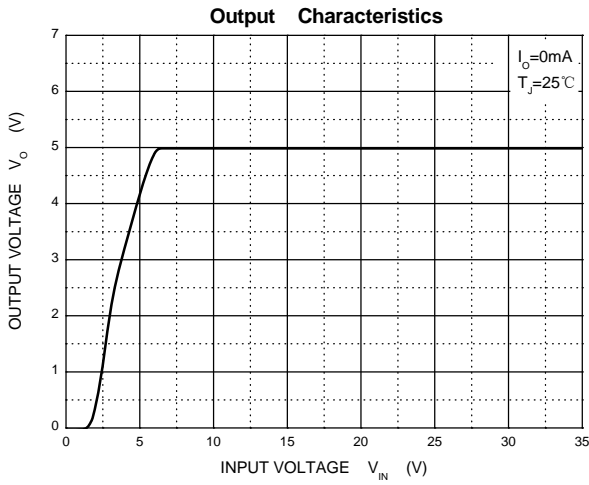

PLASTIC-ENCAPSULATE VOLTAGE REGULATORS

TO-252 Package Outline Dimensions

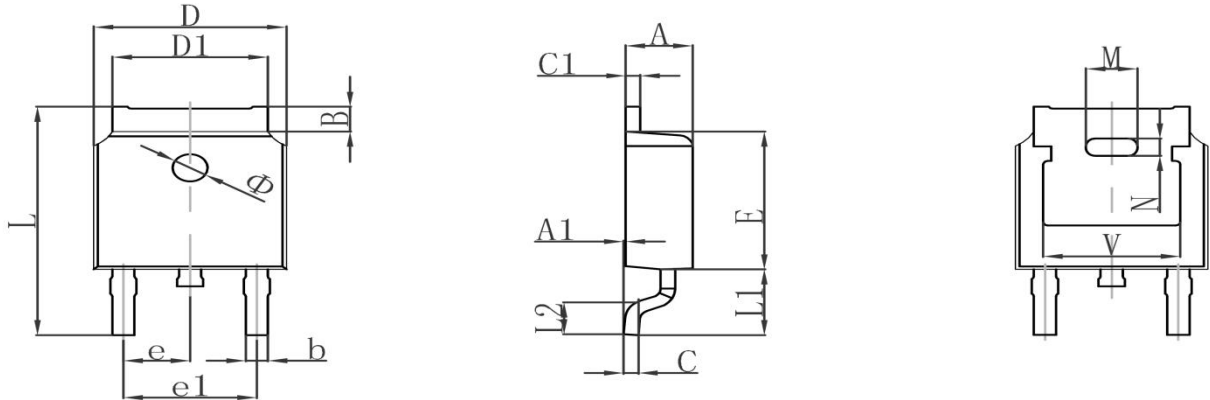

Symbol	Dimensions In Millimeters		Dimensions In Inches	
	Min.	Max.	Min.	Max.
A	2.200	2.380	0.087	0.094
A1	0.000	0.100	0.000	0.004
B	0.800	1.400	0.031	0.055
b	0.710	0.810	0.028	0.032
c	0.460	0.560	0.018	0.022
c1	0.460	0.560	0.018	0.022
D	6.500	6.700	0.256	0.264
D1	5.130	5.460	0.202	0.215
E	6.000	6.200	0.236	0.244
e	2.286TYP		0.090TYP	
e1	4.327	4.727	0.170	0.186
M	1.778REF		0.070REF	
N	0.762REF		0.018REF	
L	9.800	10.400	0.386	0.409
L1	2.9REF		0.114REF	
L2	1.400	1.700	0.055	0.067
V	4.830REF		0.190REF	
Φ	1.100	1.300	0.043	0.051

TO-252 Suggested Pad Layout

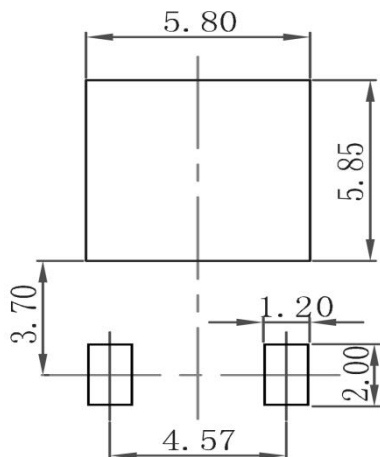

Note:

1. Controlling dimension: in millimeters
2. General tolerance: ±0.05mm
3. The pad layout is for reference purposes only

PLASTIC-ENCAPSULATE VOLTAGE REGULATORS

TO-252 Tape and Reel

TO-252 Embossed Carrier Tape

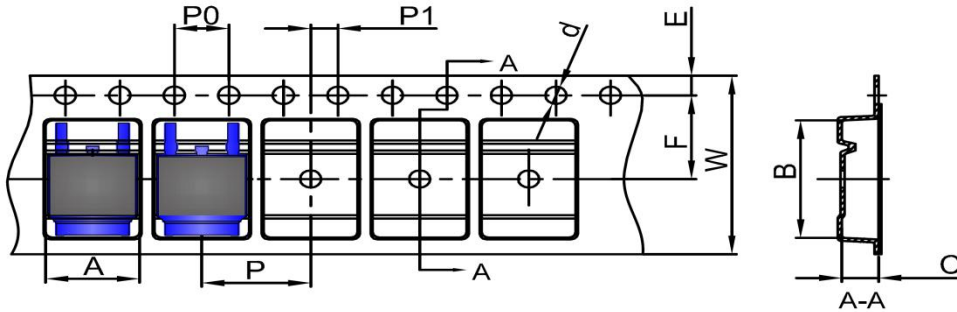

DIMENSIONS ARE IN MILLIMETER										
TYPE	A	B	C	d	E	F	P0	P	P1	W
TO-252	6.90	10.50	2.70	Ø1.55	1.75	7.50	4.00	8.00	2.00	16.00
TOLERANCE	±0.1	±0.1	±0.1	±0.1	±0.1	±0.1	±0.1	±0.1	±0.1	±0.1

TO-252 Tape Leader and Trailer

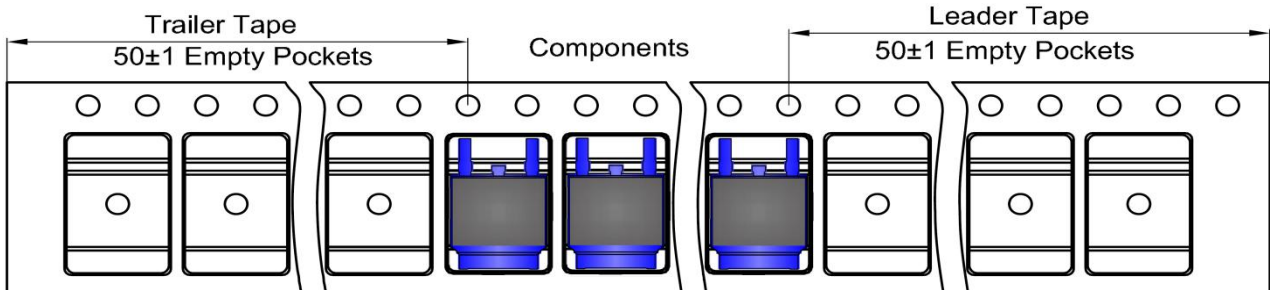

TO-252 Reel

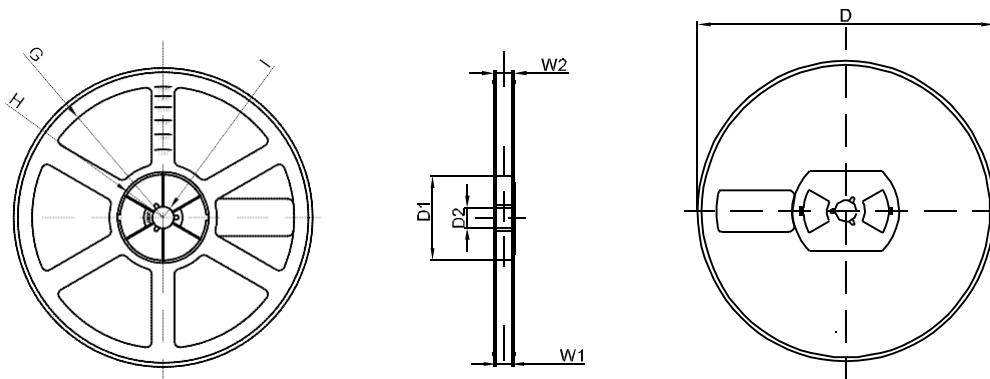

DIMENSIONS ARE IN MILLIMETER								
REEL OPTION	D	D1	D2	G	H	I	W1	W2
13" DIA	Ø330.00	100.00	Φ21.00	R151.00	R56.00	R6.50	16.40	21.00
TOLERANCE	±2	±1	±1	±1	±1	±1	±1	±1