

# 产品承认书

## SPECIFICATION FOR APPROVAL

客 户 (Customer): .....

规 格 (Description): ..... DC Brushless Fan

型 号 (Model No.): ..... YDM1238S24

样品编号 (Sample No.): ..... 20180721015-1

送样日期 (Sample Date): .....

<p>客户承认栏</p> <p>CUSTOMER APPROVAL</p>			
	<p>核 准</p> <p>APPROVED</p>	<p>审 核</p> <p>CHECKED</p>	<p>制 表</p> <p>DRAWN</p>
<p>感谢选择 YCCFAN 产品, 若样品符合贵司的要求, 劳烦将此承认书签章回传到敝司。</p> <p>Thanks for choosing YCCFAN products. Please sign and return this approval sheet to us after confirming the data.</p>	<p>姚保林</p>	<p>袁昭</p>	<p>雷雪琳</p>

### 深圳市永诚创科技有限公司

SHENZHEN YCCFAN TECHNOLOGY CO.,LTD.

### 永诚创国际(香港)有限公司

YCCFAN INTERNATIONAL ( HK ) LIMITED

地址:深圳市宝安区福海街道建安路 22 号

ADD:No.22 Jianan Rd, Fuyong Town,Baoan District,Shenzhen,China.518100

TEL:0755-29887126/27/35/36

FAX:0755-29887129

E-MAIL: [yccfan@yccfan.com](mailto:yccfan@yccfan.com)

HTTP: [www.yccfan.com](http://www.yccfan.com) [www.gdszycc.en.alibaba.com](http://www.gdszycc.en.alibaba.com)



<b>规格说明书 SPECIFICATION</b>			
(AT Ta= 25 Degree.)			
项目/ITEMS	单位/UNIT	参数/PARAMETERS	备注/NOTES
尺寸/Dimension	mm	120*120*38	Length* Width *Thickness
外框/Fan Frame	----	BLACK PBT (UL94V-0)	Glass Fiber Reinforced
扇叶/Fan Impeller	----	BLACK PBT (UL94V-0)	7 Blades
轴承种类/Bearing System	<input checked="" type="checkbox"/> S:Sleeve Bearing <input type="checkbox"/> S:Hypro Bearing <input type="checkbox"/> C:CycleSeal Bearing <input type="checkbox"/> B:Dual Ball Bearing		
额定电压/Rated Voltage	VDC	24.0	N/A
工作电压 Operating Voltage Range	VDC	21.6-26.4	At 25°C/Relative Humidity 65%
起动电压/Start-up Voltage	VDC	14.0	At 25°C/Relative Humidity 65%
额定电流/Rated Current	Amp	0.37(MAX:0.56)	At rated Voltage,Measured after 3Mins.
标签电流/Label Current	Amp	0.40	At rated Voltage,Measured after 3Mins
额定功率/Rated Power	Watt	8.88	At rated Voltage,Measured after 3Mins.
额定转速/Rated Speed	RPM	3200±10%	At rated Voltage,Measured after 3Mins.
风量/Air Flow	CFM	120.01	Maximum In Free Air,Refer to 4.2.
风压/Air Pressure	mmAq	8.31	Maximum When Air Flow = 0
噪音/Noise Level	dBA	48.54	At Rated Speed,Refer to 4.3.
马达保护/Motor Protection	Polarity Protection	Yes	Refer to 8.1.
锁机保护/Locked Motor Protection	Auto Restart	No	Refer to 8.2.
缓启动/Soft Start	----	No	N/A
速度感应/FG Sensor	Tachometer Sensor	No	Refer to 2.1.
锁机报警/RD Alarm	Locked Motor Alarm	No	Refer to 2.1.
调速控制/PWM Control	----	No	Refer to 2.2.
防水等级/Waterproof Class	<input type="checkbox"/> IP44以下	Motor or PCBa Coating by Insulating Paint	
	<input type="checkbox"/> IP55	Motor NT Vacuum Coating or PCBa Coating by Waterproof Glue	
	<input type="checkbox"/> IP56以上	Motor Coating by Epoxy Waterproof Glue or Injection by Mould	
环保要求/Conform to RoHS	----	Yes	Refer to 6.
安规规格/Safety Approval	----	<input checked="" type="checkbox"/> UL <input checked="" type="checkbox"/> CUL <input checked="" type="checkbox"/> CE	
导线/Lead Wire	UL1007/24AWGx250mm	<input checked="" type="checkbox"/> Red(+) <input checked="" type="checkbox"/> Black(-) <input type="checkbox"/> Yellow(FG) <input type="checkbox"/> White(RD) <input type="checkbox"/> Blue(PWM)	
端子/Connector	----	No	N/A
套管/Tube	----	No	-----
预估寿命/Life Expectancy	小时/Hours	30000	Refer to 7.
净重/Net Weight	克/Gram	240	N/A
装箱/Packing	件/箱/Pieces/Carton	40	N/A

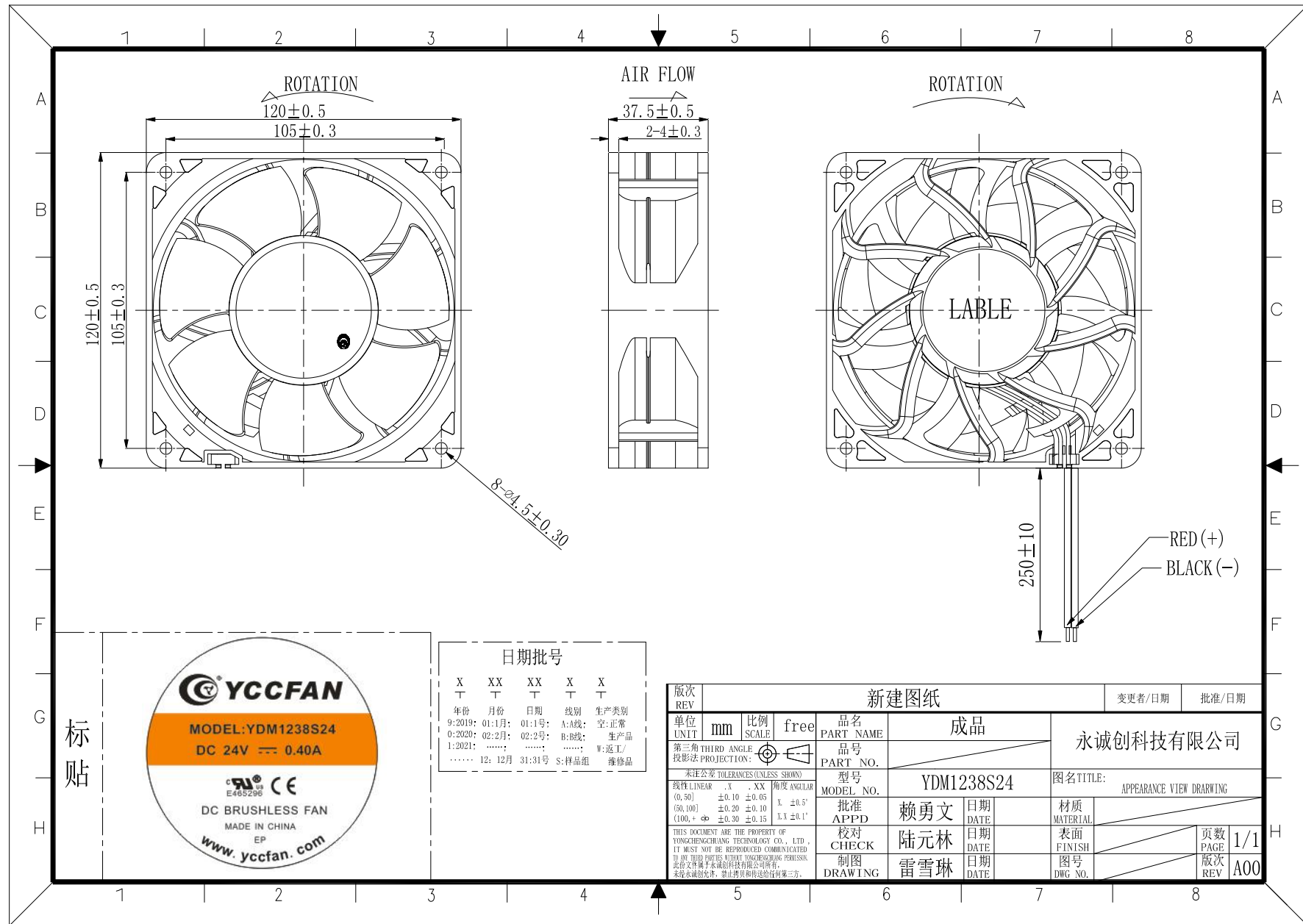

标贴



日期批号				
X	XX	XX	X	X
年份	月份	日期	线别	生产类别
9:2019	01:1月	01:1号	A:A线	空:正常
0:2020	02:2月	02:2号	B:B线	生:产品
1:2021	.....	.....	.....	W:返工/
.....	12:12月	31:31号	S:样品组	维:修品

版次 REV	新建图纸				变更者/日期	批准/日期
UNIT	mm	比例	free	品名 PART NAME	成品	永诚创科技有限公司
投影法 PROJECTION	第三角 THIRD ANGLE	图号 PART NO.	型号 MODEL NO.	YDM1238S24	图名 TITLE	
未注公差 TOLERANCES (UNLESS SHOWN)	线性 LINEAR	XX ±0.10 ±0.05 (50,100) ±0.20 ±0.10 (100,+ ∞) ±0.30 ±0.15	角度 ANGULAR	X ±0.5° XX ±0.1°	批准 APPD	赖勇文
THIS DOCUMENT ARE THE PROPERTY OF YONGCHENGCHUANG TECHNOLOGY CO., L.TD., IT MUST NOT BE REPRODUCED COMMUNICATED TO AN THIRD PARTIES WITHOUT YONGCHENGCHUANG PERMISSON. 此份文件属于永诚创科技有限公司所有。 未经许可的允许，禁止拷贝和转送给任何第三方。	校核 CHECK	陆元林	日期 DATE	日期 DATE	表面 FINISH	图号 DWG NO.
	制图 DRAWING	雷雪琳	日期 DATE	日期 DATE	材质 MATERIAL	页数 PAGE
						版次 REV
						1/1
						A00

1. 一般规格 General Specification

一般规格参见第 2 页 Refer to page 2

2. 功能介绍 Function Instruction

2.1. 信号输出 Signal Output

2.1.1. 接线说明 (FG/RD) Connection Instruction(FG/RD)

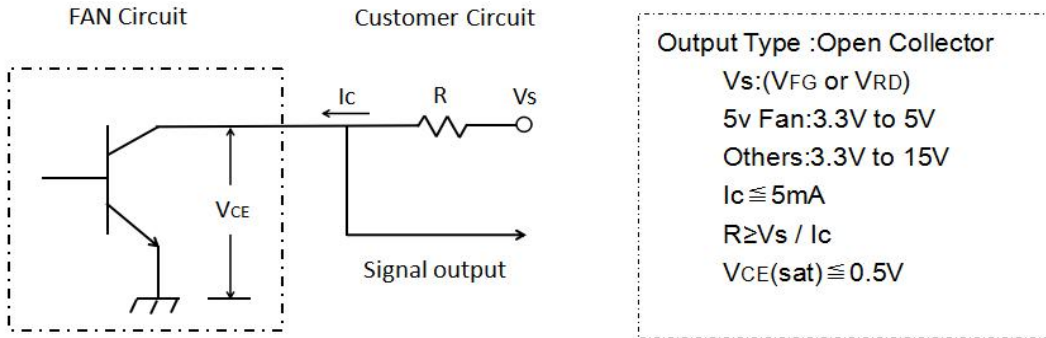

2.1.2. 输出波形 Output Waveform

2.1.2.1 方形信号 Tachometer Sensor(FG)

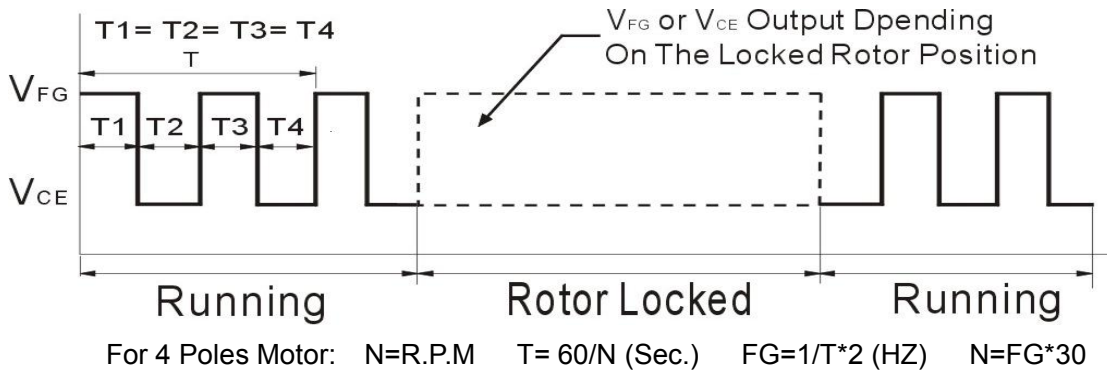

2.1.2.2. 锁机报警 Locked Motor Alarm (RD)

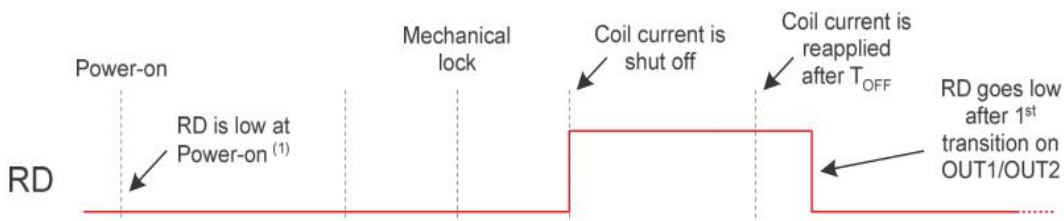

2.2. 速度控制 Speed Control(PWM)

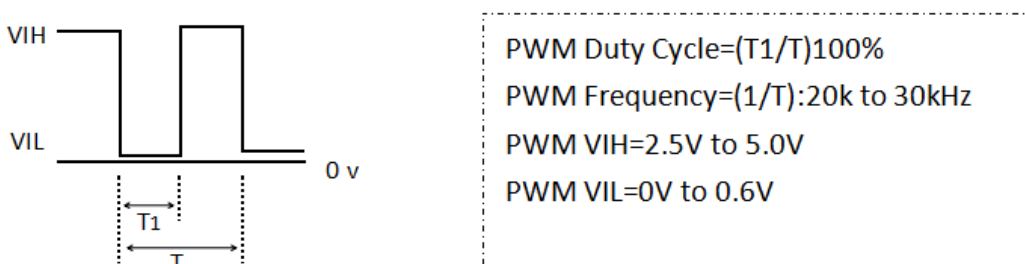

3. 电气特性 Electrical characteristics

3.1. 绝缘阻抗 Insulation resistance

框与导线正极端子之间加直流 500VDC，最小 10MΩ；  
Min 10M ohm between frame and positive terminal at 500VDC.

3.2. 绝缘耐压 Dielectric strength

框与导线正极端子之间加交流 500VAC/60Hz，1 分钟测定漏电流最大 5 mA；  
Max.5 mA between frame and positive terminal at 500VAC/60Hz for 1 minute.

3.3. 绝缘类型 Insulated Type

UL: Class A (105°C)

4. 机械特性 Mechanical Characteristics

4.1. 旋转方向 Rotation

参见第 3 页图纸所示 Refer to Page 3 Rotation

4.2. 风量风压曲线 Performance Curve

测试条件 Test Conditions: (1).Rated Voltage;(2).Room Temperature,65%Humidity;

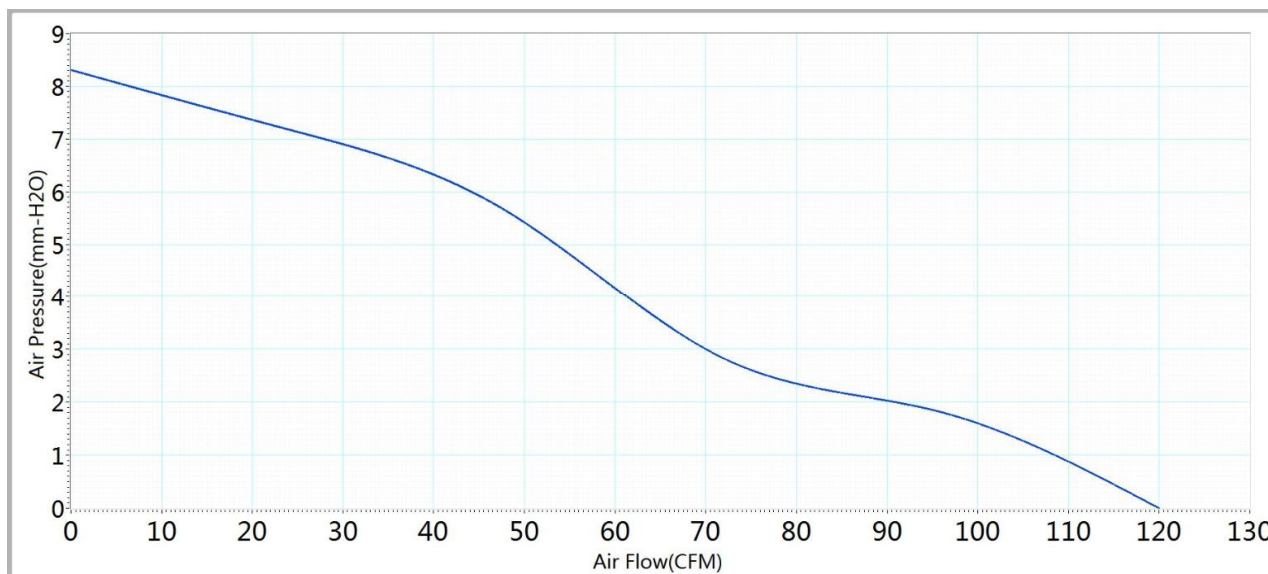

4.3 噪音 Noise Measure

4.3.1. 参照标准 ISO3745/GB4214-84，背景噪音 20±2dBa，室内环境下测量；

According to Standard ISO3745/GB4214-84, Back ground noise 20±2dBa with room condition;

4.3.2. 测试方法 Measure Condition:

风扇悬吊在无响室内，在额定电压下，麦克风距风扇进风口 1 米距离测试；

Fan is hanged in anechoic chamber, measured at rated voltage, measure microphone at a distance of one meter from the fan air intake;

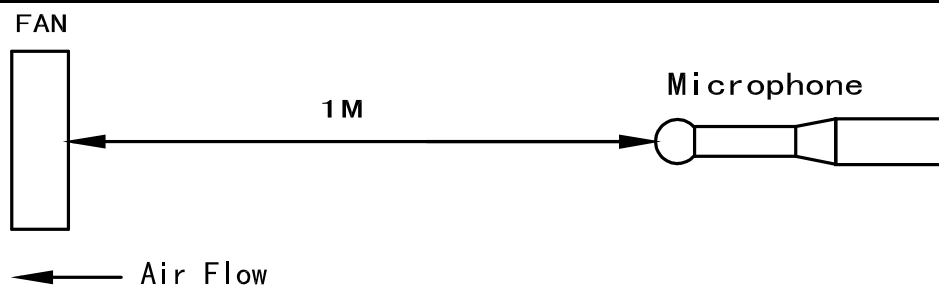

5. 环境适应 Environmental

5.1. 运转温度 Operating Temperature	-----	-10 ~ +70 °C
5.2. 储存温度 Storage Temperature	-----	-40 ~ +75 °C
5.3. 运转湿度 Operating Humidity	-----	35% ~ 85%RH
5.4. 储存湿度 Storage Humidity	-----	35% ~ 85%RH

6. 环保要求 RoHS Compliance

产品有害物质的含量符合欧盟指令 2014/35/EU 的要求;  
 Product is in compliance with RoHS 2014/35/EU requirement;

7. 预期寿命 Life Expectancy

- 7.1. Conditions: .At Confidence Level 90%;Rated Voltage;65% Humidity Environment
- 7.2.  S: Sleeve Bearing System:30000 Hours At 25°C Environment
- S: Hypro Bearing System:30000 Hours At 40°C Environment
- C: CycleSeal Bearing System:40000 Hours At 40°C Environment
- B: Dual Ball Bearing System:50000 Hours At 40°C Environment

8. 马达保护 Motor Protection

8.1. 极性保护 Polarity Protection

如果产品的正负极电源线接反，产品能够承受 10 分钟不被损坏；

Be capable of withstanding 10 minutes will not cause damage if reverse connection for positive and negative lead wires;

8.2. 马达锁住保护 Locked Rotor Protection

在正常操作电压和温度范围下，当转子被锁住后，电路电流会被关闭或维持很小范围保护马达在 72 小时内不会损坏；

The current will be shut down or remain a little range to protect motor from damaged in 72 hours when locking rotor at operation voltage and temperature range;

9 安全批准 Safety Approvals

参见第二页 Refer to page 2