



# ORIENT

## Photo coupler

### Product Data Sheet

Part Number: OR-3H4-(GK)

Customer: \_\_\_\_\_

Date: \_\_\_\_\_

**SHENZHEN ORIENT COMPONENTS CO.,LTD.**

Block A 3rd Floor No.4 Building,Tian'an Cyber Park,Huangge Rd,LongGang Dist,Shenzhen,GD

TEL: 0755-29681816

FAX: 0755-29681200

[www.orient-opto.com](http://www.orient-opto.com)

## 1. Features

- (1) Current transfer ratio(CTR) : MIN. 20% at  $I_F = \pm 1\text{mA}$ ,  $V_{CE} = 5\text{V}$ ,  $T_a = 25^\circ\text{C}$
- (2) High input-output isolation voltage.(VISO=3,750Vrms)
- (3)  $BV_{CEO} = 80\text{V(MIN)}$
- (4) Operating temperature:-55°C to 125°C
- (5) ESD pass HBM 8000V/MM 2000V
- (6) Safety approval
  - UL approved(No.E323844)
  - VDE approved(No.40029733)
  - CQC approved (No.CQC19001231256)
- (7) In compliance with RoHS, REACH standards
- (8) MSL Class I

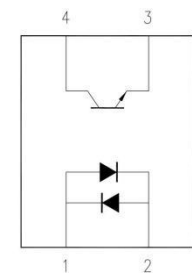

1. Anode, Cathode 3. Emitter  
2. Cathode, Anode 4. Collector

## 2. Instructions

The OR-3H4-(GK) series device contains two infrared led and a photo transistor detector.They are encapsulated in a 4-pin SOP, free of halogens and Sb2O3

## 3. Application Range

- (1) Hybrid substrates that require high density mounting
- (2) Programmable controller
- (3) System apparatus,measuring instruments

## 4. Max Absolute rated Value (Normal Temperature=25°C)

Parameter		Symbol	Rated Value	Unit
Input	Forward Current	$I_F$	50	mA
	Peak forward current( $t=10\mu\text{s}$ )	$I_{FM}$	1	A
	Reverse Voltage	$V_R$	6	V
	Power Dissipation	$P$	65	mW
	Junction Temperature	$T_j$	125	°C
Output	Collector and emitter Voltage	$V_{CEO}$	80	V
	Emitter and collector Voltage	$V_{ECO}$	7	
	Collector Current	$I_C$	50	mA
	Power Dissipation	$P_C$	150	mW
	Junction Temperature	$T_j$	125	°C
Total Power Dissipation		$P_{tot}$	200	mW
*1 Insulation Voltage		$V_{iso}$	3750	Vrms
Operating Temperature		$T_{opr}$	-55 to +125	°C
Storage Temperature		$T_{stg}$	-55 to +150	
*2 Soldering Temperature		$T_{sol}$	260	

\*1. AC For 1 Minute, R.H. = 40 ~ 60%

Isolation voltage shall be measured using the following method.

- (1) Short between anode and cathode on the primary side and between collector and emitter on the secondary side.
- (2) The isolation voltage tester with zero-cross circuit shall be used.
- (3) The waveform of applied voltage shall be a sine wave.

\*2.soldering time is 10 seconds.

## 5. Opto-electronic Characteristics(Normal Temperature=25°C)

Parameter		Symbol	Min	Typ.*	Max	Unit	Condition
Input	Forward Voltage	$V_F$	---	1.2	1.4	V	$I_F=\pm 20\text{mA}$
	Terminal Capacitance	$C_t$	---	60	---	pF	$V=0, f=1\text{KHz}$
Output	Collector Dark Current	$I_{CEO}$	---	---	100	nA	$V_{CE}=20\text{V}, I_F=0\text{mA}$
	Collector-Emitter Breakdown Voltage	$BV_{CEO}$	80	---	---	V	$I_C=0.1\text{mA}, I_F=0\text{mA}$
	Emitter-Collector Breakdown Voltage	$BV_{ECO}$	7	---	---	V	$I_E=0.1\text{mA}, I_F=0\text{mA}$
	*1 Current Transfer Ratio	CTR	20	---	400	%	$I_F=\pm 1\text{mA}$ $V_{CE}=5\text{V}$
	Collector Current	$I_C$	2	---	40	mA	
Transforming Characteristics	Collector-Emitter Saturation Voltage	$V_{CE(sat)}$	---	---	0.4	V	$I_F=\pm 8\text{mA}$ $I_C=2.4\text{mA}$
	Insulation Impedance	$R_{iso}$	$5 \times 10^{10}$	$1 \times 10^{11}$	---	$\Omega$	DC500V 40~60%R.H.
	Floating Capacitance	$C_f$	---	0.8	1	pF	$V=0, f=1\text{MHz}$
	Response Time	$t_r$	---	3	18	$\mu\text{s}$	$V_{CE}=10\text{V}$ $I_C=2\text{mA}$ $R_L=100\Omega$
	Descend Time	$t_f$	---	4	18	$\mu\text{s}$	

- Current Conversion Ratio =  $I_C / I_F \times 100\%$

## 6. Rank table of current transfer ratio CTR

MODEL NO.	CTR Rank	Min.	Max.	Unit	Condition
OR-3H4-(GK)	NO mark	20	400	%	IF=±1mA, V <sub>CE</sub> =5V, Ta=25°C
	A	50	250		
	B	100	400		
	C	100	200		
	GR	100	300		IF=±5mA, V <sub>CE</sub> =5V, Ta=25°C

- Current Conversion Ratio =  $I_C / I_F \times 100\%$

## 7. Order Information

### Part Number

**OR-3H4W-X-Y-Z-(GK)**

### Note

W = CTR Rank (A, B, C, GR or none)

X = Tape and reel option (TP or TP1).

Y = 'V' code for VDE safety (This options is not necessary).

Z = 'G' code for Halogen free.

GK = Field code.

\* VDE Code can be selected.

Option	Description	Packing quantity
TP	Surface mount lead form (low profile) + TP tape & reel option	3000 units per reel
TP1	Surface mount lead form (low profile) + TP1 tape & reel option	3000 units per reel

## 8. Naming Rule

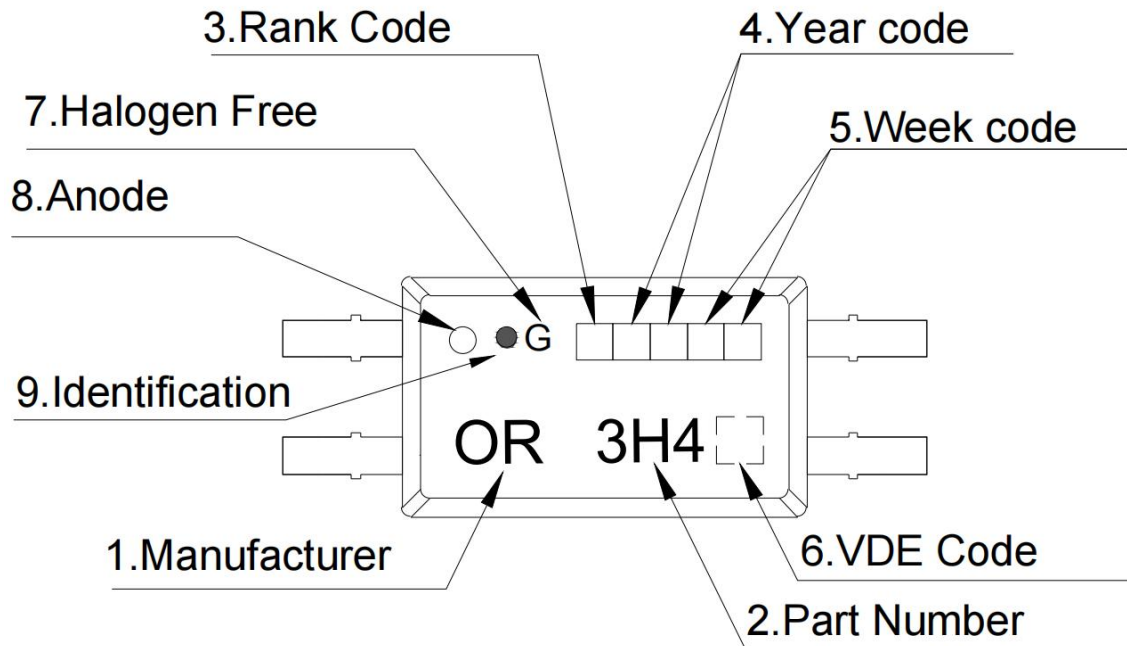

1. Manufacturer : ORIENT.
2. Part Number : 3H4.
3. Rank Code : CTR Rank
4. Year Code  : '0' means '2020' and so on.
5. Week Code : 01 means the first week, 02 means the second week and so on.
6. VDE Code . (Optional)
7. HF Code 'G': Halogen Free.
8. Anode.
9. Identification.

\* VDE Code can be selected.

### 9. Outer Dimension

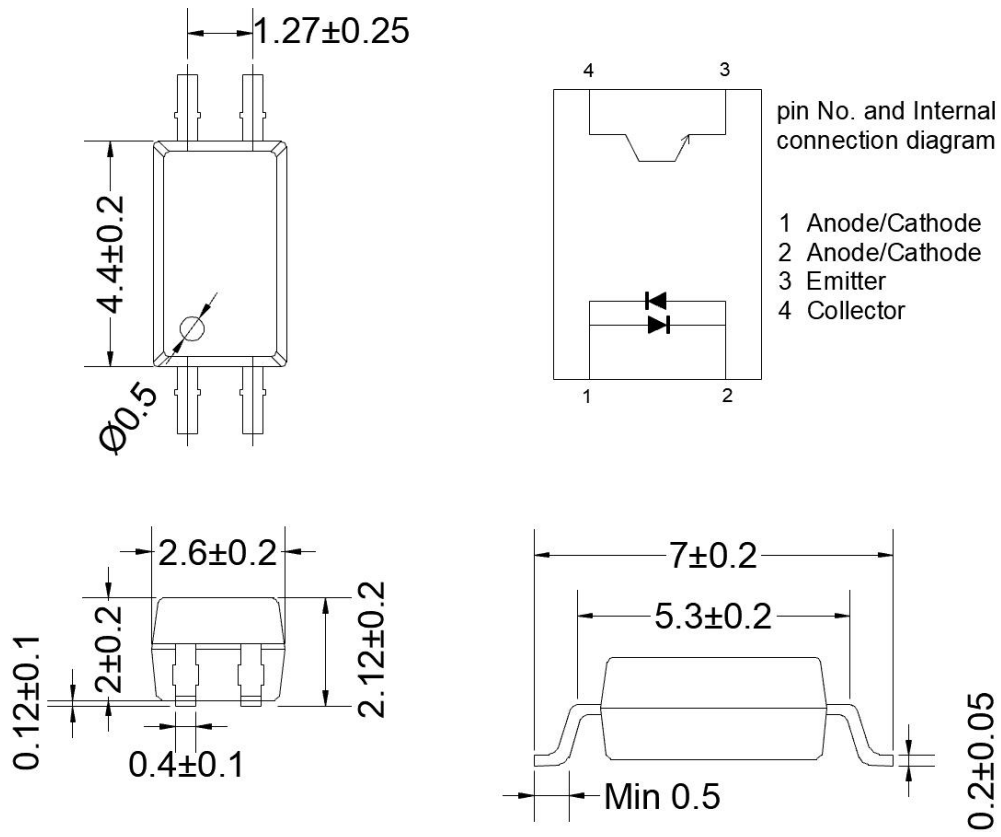

### 10. Recommended Foot Print Patterns (Mount Pad) (unit: mm)

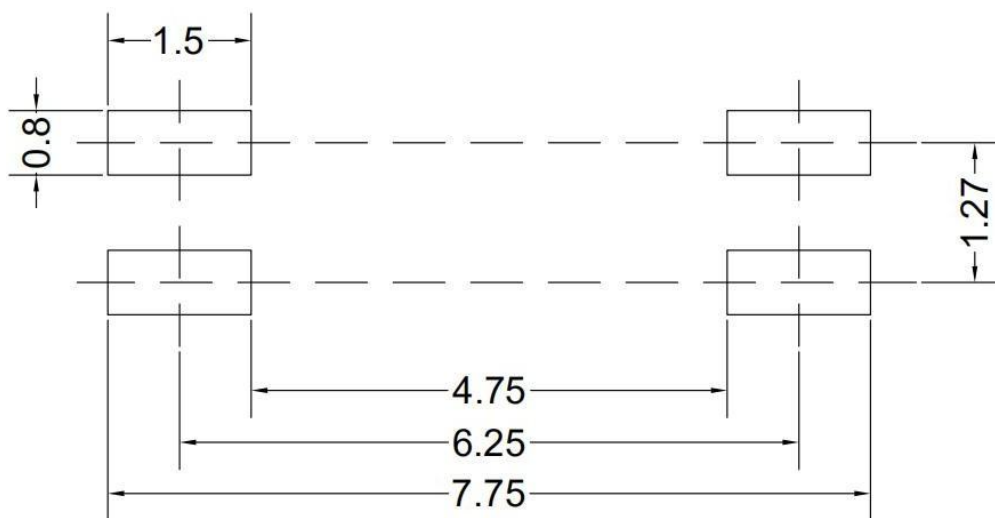

### 11. Taping Dimensions

#### (1)OR-3H4-TP

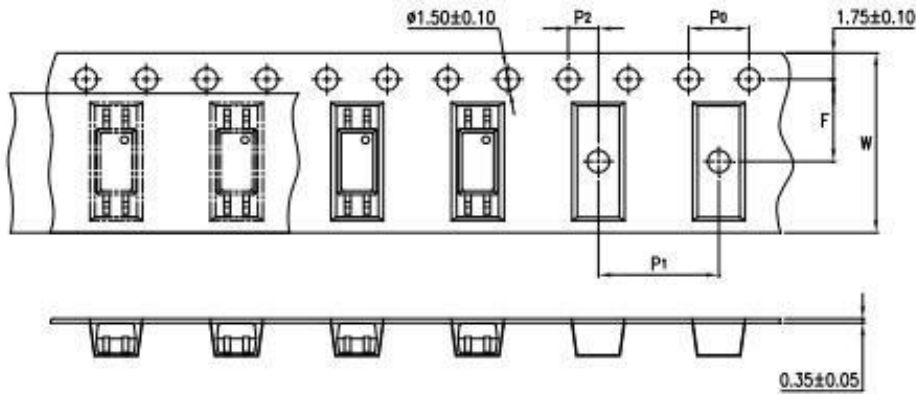

#### (2)OR-3H4-TP1

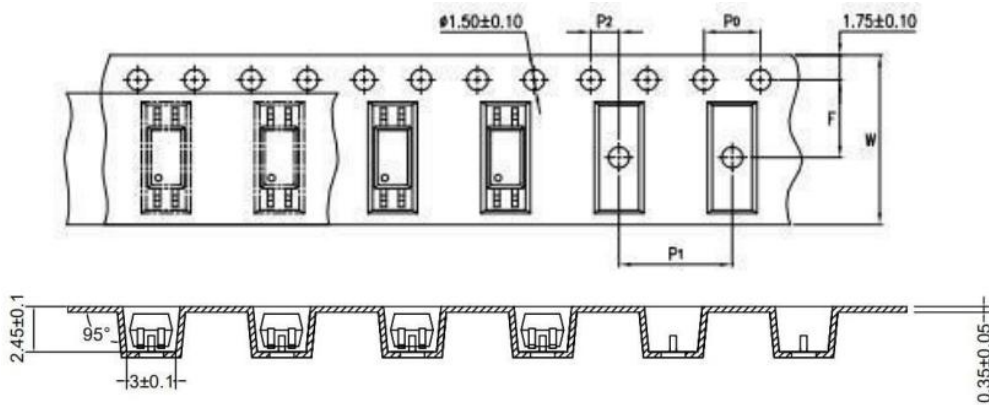

type	Symbol	Dimensions: mm (in.)
bandwidth	W	12±0.3 (0.47)
pitch	P0	4±0.1 (0.15)
pitch	F	5.5±0.1 (0.217)
	P2	2±0.1 (0.079)
interval	P1	8±0.1 (0.315)

Encapsulation type	TP/TP1
Quantity (pieces)	3000

## 12. Package Dimension

### (1) package dimension

Packing Information	
Packing type	Reel type
Tape Width	12mm
Qty per Reel	3,000pcs
Small box (inner) Dimension	345*345*45mm
Large box (Outer) Dimension	480x360x360mm
Max qty per small box	6,000pcs
Max qty per large box	60,000pcs

### (2)Packing Label Sample



**ORIENT**  
ShenZhen Orient  
Components Co.,LTD





Material Code : 120PCXXXXXX  
  
P/N : OR-XXXXXX  
  
Lot No. : XXXXXX-XXXX-TX-X  
  
D/C : XXXX  
  
Qty : XXXX PCS  

内箱码

外箱码

“XXXXXXXXXXXXXXXX” (一体机序列码)  
**Made in China**

**Note :**

1. Material Code :Product ID.
2. P/N :Contents with "Order Information" in the specification.
3. Lot No. :Product data.
4. D/C :Product weeks.
5. Quantity :Packaging quantity.



### 13. Reliability Test

NO.	ITEMS	Reliability Testing				
		QTY. (Pcs)	Condition	Process	Device	Standard
1	RSH 耐焊接热	22	260±5℃	10s/3 次	锡炉	JESD22-A106
2	HTSL 高温存储	77	125℃	168 hrs	高温烤箱 测试仪	JESD22-A103
				500 hrs		
				1000 hrs		
3	LTSL 低温存储	77	-55℃	168 hrs	低温箱 测试仪	JESD22-A119
				500 hrs		
				1000 hrs		
4	TC 温度循环	77	H:125℃ 15min ∫ 5min L:-55℃ 15min	300 cycle	冷热冲击机	JESD22-A104
5	TS 温度冲击	77	H:100℃ 5min ∫ 15s L:-40℃ 5min	300 cycle	冷热冲击机	JESD22-A106
6	HTOL 高温操作	77	110℃ IF=10mA Vce=5V	168 hrs	高温烤箱 测试仪、老 化电路板	JESD22-A108
				500 hrs		
				1000 hrs		
7	ESD-HBM 人体模式	22	≥8KV 1Cycle	1次	ESD静电测 试仪	JESD22-A114
8	SD 可焊性	22	Pb-free 245±5℃	5S/1次	锡炉	JESD22-B102
9	HTRB 高温反向偏压	77	HTRB @125℃ Vce=80v	168 hrs	高温烤箱 , 测试仪	JESD22-A103
				500 hrs		
				1000 hrs		
10	H3TRB 温湿度反向偏 压, 寿命试验	77	H3TRB 85℃,85%RH Vce=80v	168 hrs	恒温恒湿 机, 测试仪	JESD22-A101
				500 hrs		
				1000 hrs		
11	Autoclave 压力锅	77	Ta=121 ℃,100%RH,2atm	96hrs	压力锅	JESD22-A102

## 14. Temperature Profile Of Soldering

### ( 1 ) IR Reflow soldering (JEDEC-STD-020C compliant)

One time soldering reflow is recommended within the condition of temperature and time profile shown below. Do not solder more than three times.

Profile item	Conditions
Preheat	
- Temperature Min (T Smin )	150°C
- Temperature Max (T Smax )	200°C
- Time (min to max) (ts)	90±30 sec
Soldering zone	
- Temperature (TL )	217°C
- Time (t L )	60 sec
Peak Temperature	260°C
Peak Temperature time	20 sec
Ramp-up rate	3°C / sec max.
Ramp-down rate from peak temperature	3~6°C / sec
Reflow times	≤3

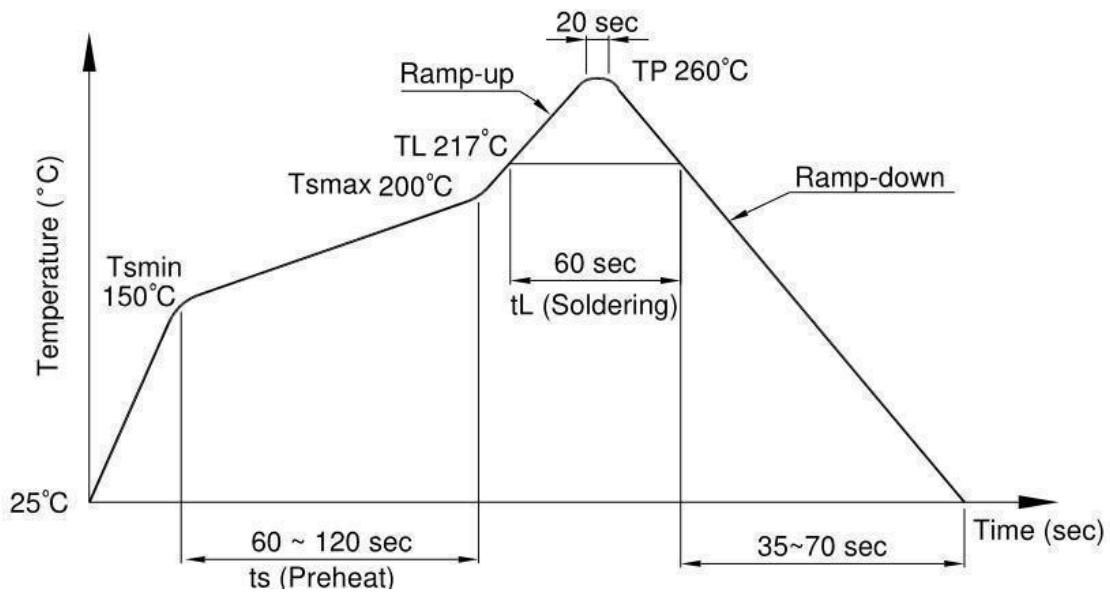

**( 2 ) Wave soldering (JEDEC22A111 compliant)**

One time soldering is recommended within the condition of temperature.

Temperature	260+0/-5°C
Time	10 sec
Preheat temperature	25 to 140°C
Preheat time	30 to 80 sec

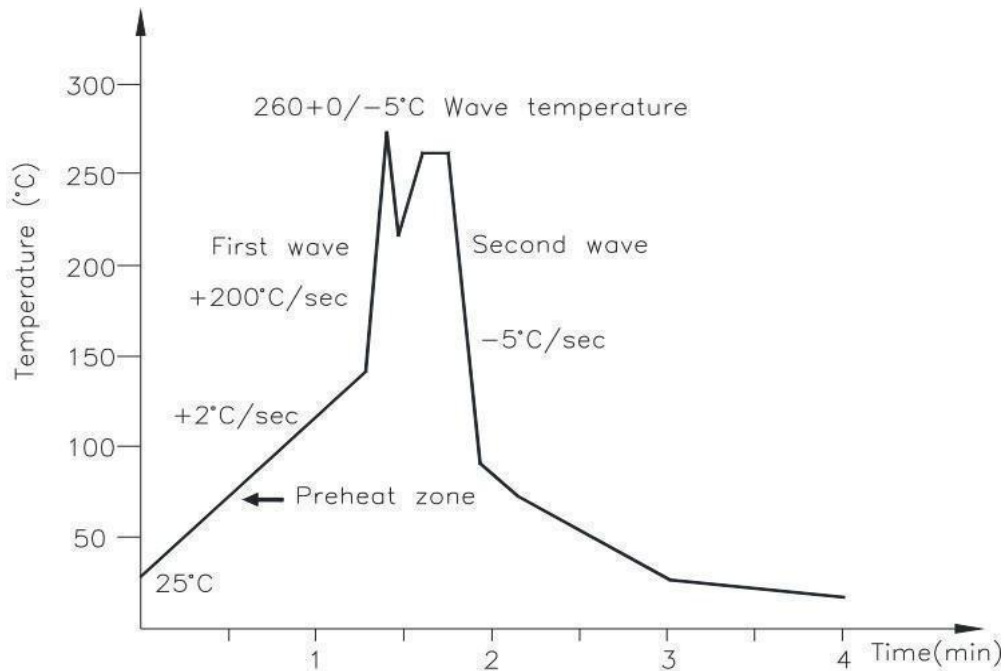

**( 3 ) Hand soldering by soldering iron**

Allow single lead soldering in every single process. One time soldering is recommended.

Temperature	380+0/-5°C
Time	3 sec max

### 15. Characteristics Curve

Figure 1. Collector Power Dissipation vs. Ambient Temperature

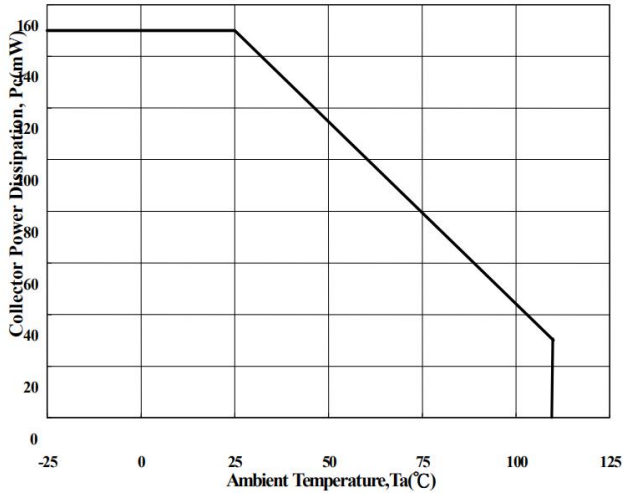

Figure 2. Forward Current vs. Ambient Temperature

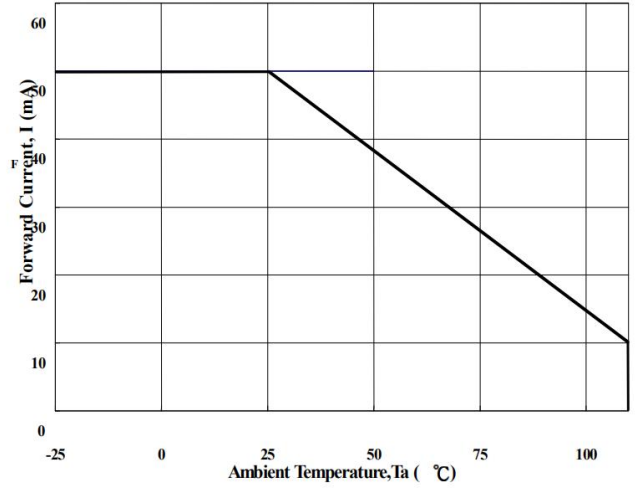

Figure 3. Forward Current vs. Forward Voltage

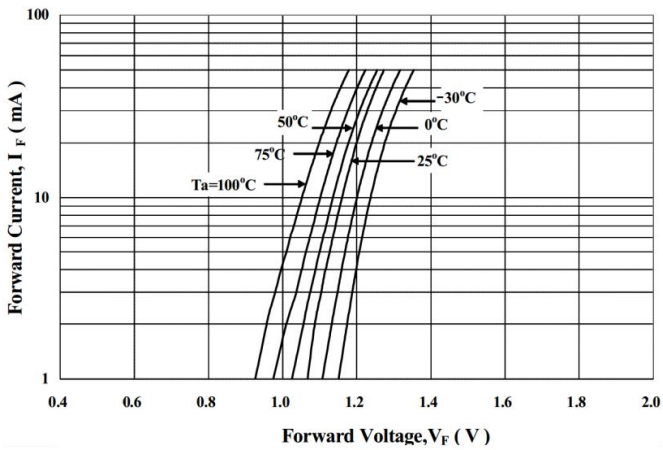

Figure 4. Forward Voltage Temperature Coefficient vs. Forward Current

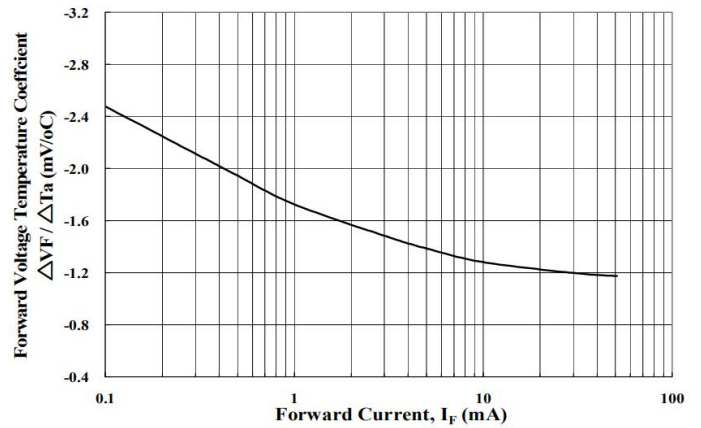

Figure 5. Pulse Forward Current vs. Duty Cycle Ratio

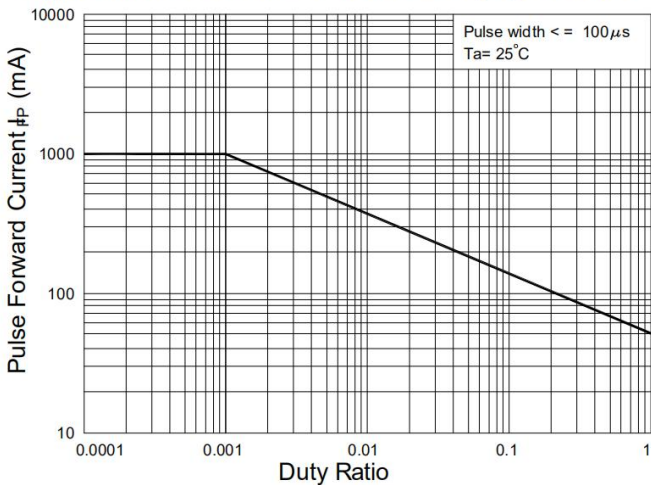

Figure 6. Pulse Forward Current vs. Pulse Forward Voltage

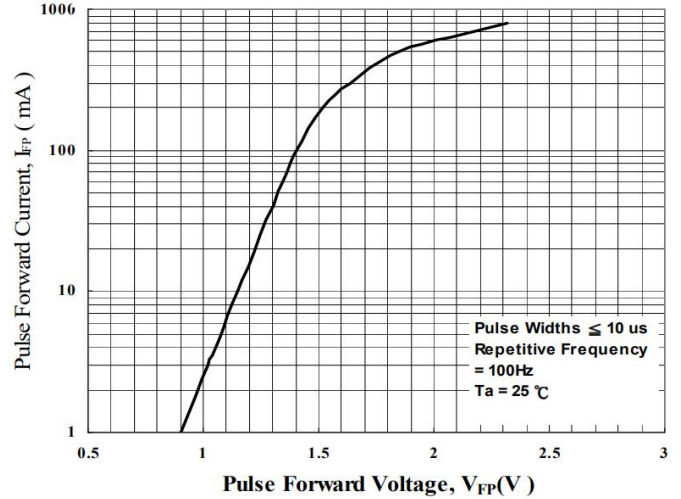

Figure 7. Collector-Emitter Saturation Voltage vs. Forward

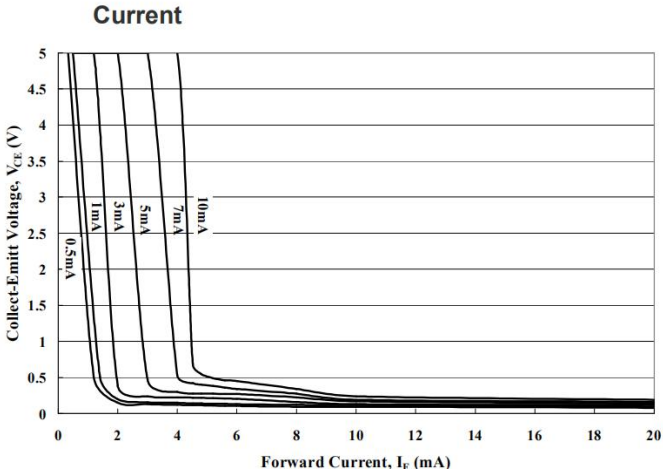

Figure 8. Collector Current vs. Collector-Emitter

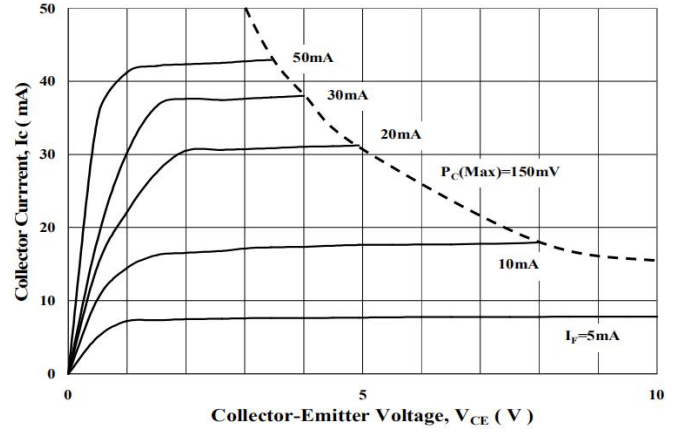

Figure 9. Collector Current vs. Small Collector-Emitter

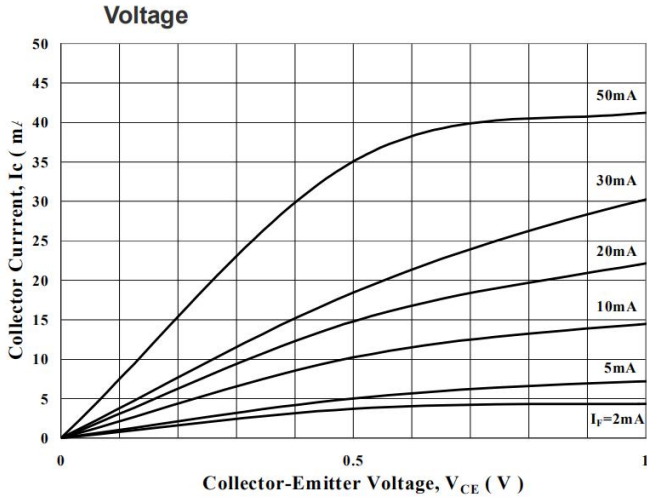

Figure 10. Normalized CTR vs. Forward Current

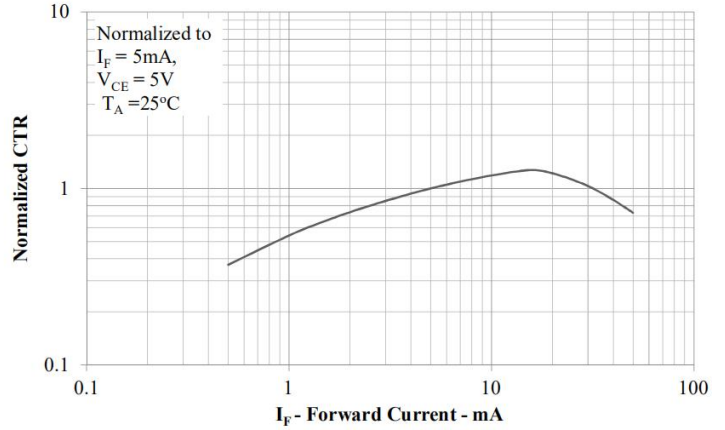

Figure 11. Collector Dark Current vs. Ambient Temperature

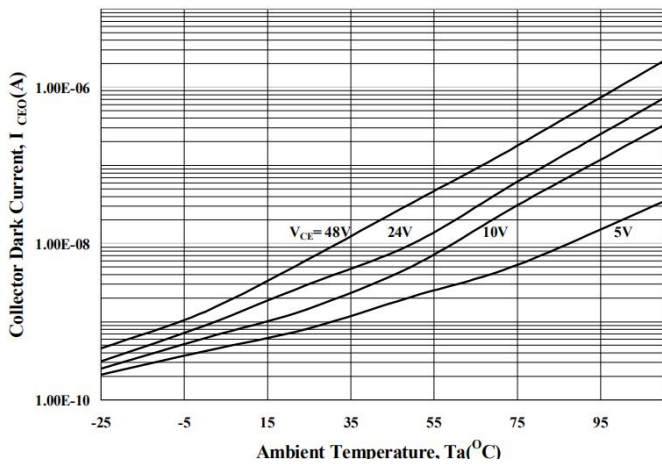

Figure 12. Current Transfer Ratio vs. Forward

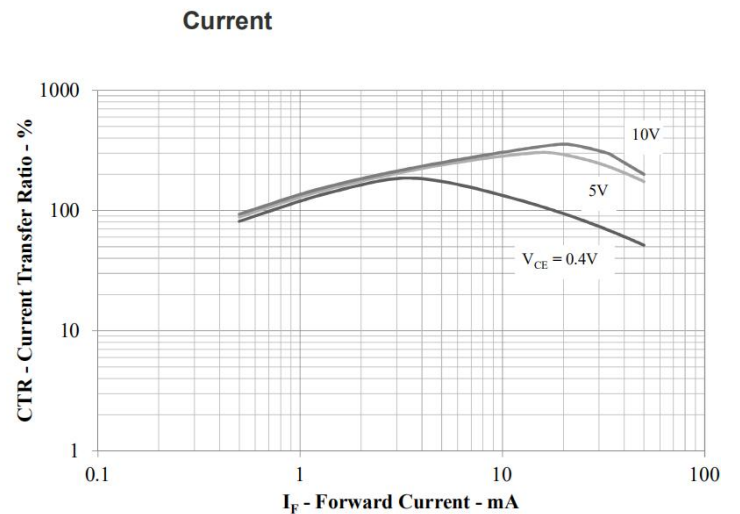

Figure 13. Normalized CTR vs. Ambient Temperature

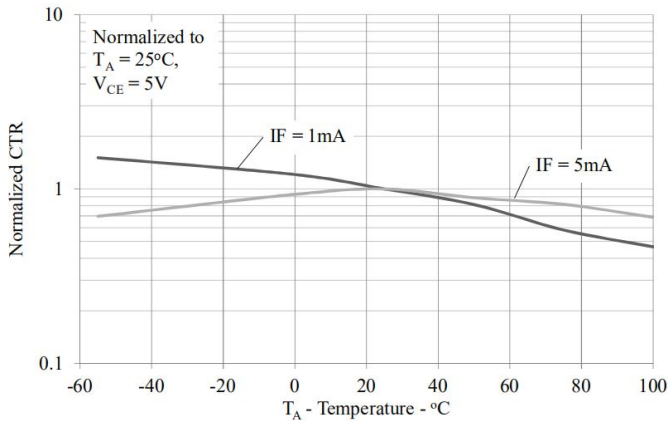

Figure 14. Collector-Emitter Saturation Voltage vs. Ambient Temperature

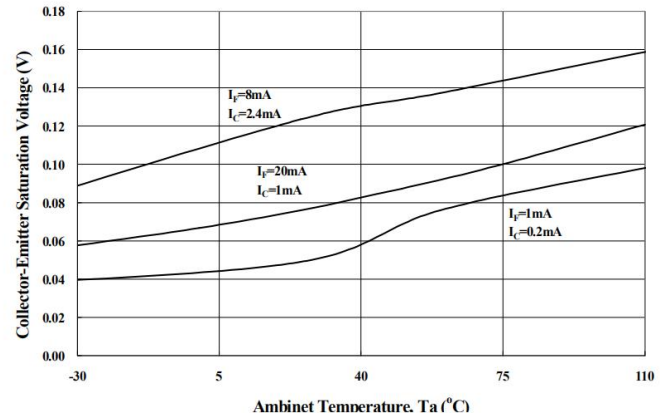

Figure 15. Collector Current vs. Ambient Temperature

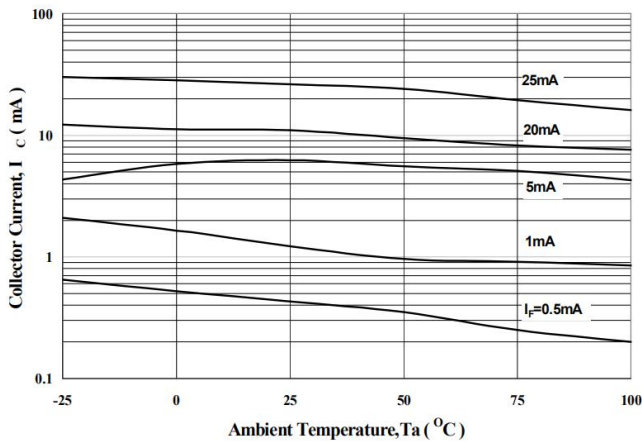

Figure 16. Switching Time vs. Load Resistance

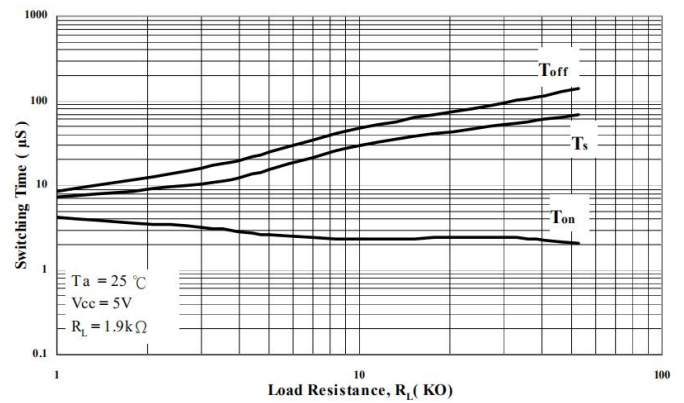

Figure 17. Switching Time vs. Ambient Temperature

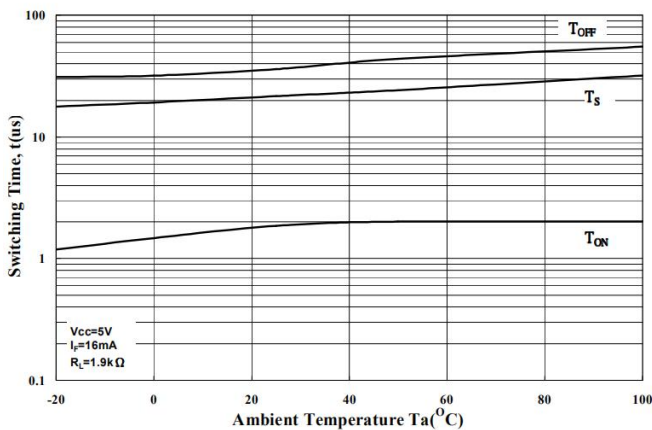

Figure 18. Frequency Response

