

## ■ 繞綫型片式鐵氧體電感

### WIRE WOUND CHIP FERRITE INDUCTORS



#### ● 特征 FEATURES:

- 體積小，適合高密度表面貼裝；
- 採用端電極結構，很好地抑制了引綫引起的寄生元件效應，具有高可靠性；
- 低電阻、高電流和高電感量；
- 優良的焊接性和耐焊性。
- Miniature size, suitable for SMT;
- Using terminal electrode structure to restrain the parasitic component effect quite caused by lead;
- low DC resistance , high current and high inductance;
- Excellent in solderability and heat resistance.

#### ● 應用 APPLICATIONS

- 視聽設備，無線通訊設備和各類通用電子設備；
- 其他電子設備，包括硬盤和光驅。
- Wireless communication equipment and various types of general electronic equipment;
- Other electronic equipment including HDDs and ODDs.

#### ● 產品規格型號的表示方法 ORDERING CODE

$\frac{FHW}{①}$      $\frac{0805}{②}$      $\frac{UF}{③}$      $\frac{1R0}{④}$      $\frac{J}{⑤}$      $\frac{S}{⑥}$      $\frac{T}{⑦}$

①	②	③	④	⑤	⑥	⑦																																								
產品代號 Code	規格尺寸 Dimensions (L × W) (mm)	材料 Material	感量(nH) Inductance	誤差(%) Tolerance	電極 Terminal	包裝方式 Packaging Style																																								
FHW	<table border="1"> <tr><td>0603</td><td>1.6×0.8</td></tr> <tr><td>0805</td><td>2.0×1.2</td></tr> <tr><td>1008</td><td>2.5×2.0</td></tr> <tr><td>1210</td><td>3.2×2.5</td></tr> <tr><td>1812</td><td>4.5×3.2</td></tr> </table>	0603	1.6×0.8	0805	2.0×1.2	1008	2.5×2.0	1210	3.2×2.5	1812	4.5×3.2	<table border="1"> <tr><td>UF</td><td>鐵氧體芯 Ferrite</td></tr> <tr><td>IF</td><td></td></tr> </table>	UF	鐵氧體芯 Ferrite	IF		<table border="1"> <tr><td>1N0</td><td>1.0</td></tr> <tr><td>010</td><td>10</td></tr> <tr><td>R10</td><td>100</td></tr> <tr><td>1R0</td><td>1000</td></tr> <tr><td>100</td><td>10000</td></tr> <tr><td>101</td><td>100000</td></tr> <tr><td>102</td><td>1000000</td></tr> </table>	1N0	1.0	010	10	R10	100	1R0	1000	100	10000	101	100000	102	1000000	<table border="1"> <tr><td>J</td><td>±5</td></tr> <tr><td>K</td><td>±10</td></tr> <tr><td>M</td><td>±20</td></tr> </table>	J	±5	K	±10	M	±20	<table border="1"> <tr><td>S</td><td>TIN</td></tr> </table>	S	TIN	<table border="1"> <tr><td>T</td><td>卷帶盤裝 Tape&amp;Reel</td></tr> <tr><td>B</td><td>散裝Bulk</td></tr> </table>	T	卷帶盤裝 Tape&Reel	B	散裝Bulk
0603	1.6×0.8																																													
0805	2.0×1.2																																													
1008	2.5×2.0																																													
1210	3.2×2.5																																													
1812	4.5×3.2																																													
UF	鐵氧體芯 Ferrite																																													
IF																																														
1N0	1.0																																													
010	10																																													
R10	100																																													
1R0	1000																																													
100	10000																																													
101	100000																																													
102	1000000																																													
J	±5																																													
K	±10																																													
M	±20																																													
S	TIN																																													
T	卷帶盤裝 Tape&Reel																																													
B	散裝Bulk																																													

#### ● 外形尺寸 DIMENSIONS

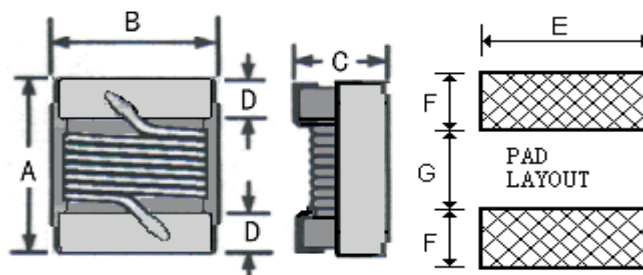

## 繞線型片式電感器

## WIRE WOUND CHIP INDUCTORS

單位(Unit): mm/inch

Par NO.	A (Max.)	B (Max.)	C (Max.)	D	E	F	G
0603	1.78 (.070)	1.10 (.043)	0.95 (.037)	0.30 (.012)	1.02 (.04)	0.64 (.025)	0.64 (.025)
0805	2.30 (.091)	1.70 (.067)	1.52 (.060)	0.50 (.020)	1.78 (.07)	1.02 (.04)	0.76 (.03)
1008	2.92 (.115)	2.79 (.110)	2.10 (.083)	0.5 (.020)	2.54 (.10)	1.02 (.04)	1.27 (.05)
1210	3.50 (.138)	2.90 (.114)	2.25 (.088)	0.50 (.020)	2.54 (.10)	1.02 (.04)	1.78 (.07)
1812	4.80 (.189)	3.40 (.134)	3.15 (.124)	0.65 (.026)	3.05 (.12)	1.14 (.045)	3.00 (.118)

### • 電性能參數 ELECTRICAL CHARACTERISTICS

#### 0603UF Series

PartNumber	Inductance (nH)	Tolerance (%)	Q ( min)	SRF(MHz) Min	Rdc( Ω ) Max	Idc( mA) Max
FHW0603UFR10□ST	100@7.9MHz	10,5	12@7.9MHz	1150	0.13	1000
FHW0603UFR12□ST	120@7.9MHz	10,5	12@7.9MHz	1100	0.16	1000
FHW0603UFR15□ST	150@7.9MHz	10,5	12@7.9MHz	1050	0.15	1000
FHW0603UFR18□ST	180@7.9MHz	10,5	12@7.9MHz	950	0.15	1000
FHW0603UFR22□ST	220@7.9MHz	10,5	12@7.9MHz	900	0.16	900
FHW0603UFR27□ST	270@7.9MHz	10,5	12@7.9MHz	775	0.30	700
FHW0603UFR33□ST	330@7.9MHz	10,5	12@7.9MHz	725	0.32	600
FHW0603UFR39□ST	390@7.9MHz	10,5	12@7.9MHz	620	0.51	500
FHW0603UFR47□ST	470@7.9MHz	10,5	12@7.9MHz	540	0.62	420
FHW0603UFR56□ST	560@7.9MHz	10,5	12@7.9MHz	600	0.65	400
FHW0603UFR68□ST	680@7.9MHz	10,5	12@7.9MHz	500	1.00	380
FHW0603UFR82□ST	820@7.9MHz	10,5	12@7.9MHz	500	1.30	350
FHW0603UF1R0□ST	1000@7.9MHz	10,5	12@7.9MHz	400	1.50	330
FHW0603UF1R2□ST	1200@7.9MHz	10,5	12@7.9MHz	380	1.70	320
FHW0603UF1R5□ST	1500@7.9MHz	10,5	12@7.9MHz	300	1.90	310
FHW0603UF1R8□ST	1800@7.9MHz	10,5	12@7.9MHz	180	2.20	300
FHW0603UF2R2□ST	2200@7.9MHz	10,5	12@7.9MHz	180	2.30	280
FHW0603UF2R7□ST	2700@7.9MHz	10,5	12@7.9MHz	150	2.60	250
FHW0603UF3R3□ST	3300@7.9MHz	10,5	12@7.9MHz	150	2.90	230
FHW0603UF3R9□ST	3900@7.9MHz	10,5	12@7.9MHz	120	3.20	210
FHW0603UF4R7□ST	4700@7.9MHz	10,5	12@7.9MHz	100	4.00	200

### 0805UF Series

PartNumber	Inductance ( $\mu$ H)	Tolerance (%)	Q (min)	SRF(MHz) Min	Rdc( $\Omega$ ) Max	Idc( mA) Max
FHW0805UF1R0□ST	1.0@7.96MHz	10,5	12@7.96MHz	360	1.00	430
FHW0805UF1R2□ST	1.2@7.96MHz	10,5	12@7.96MHz	350	1.15	410
FHW0805UF1R5□ST	1.5@7.96MHz	10,5	12@7.96MHz	300	1.20	400
FHW0805UF1R8□ST	1.8@7.96MHz	10,5	12@7.96MHz	200	1.35	380
FHW0805UF2R2□ST	2.2@7.96MHz	10,5	12@7.96MHz	170	1.50	350
FHW0805UF2R7□ST	2.7@7.96MHz	10,5	12@7.96MHz	100	1.70	320
FHW0805UF3R3□ST	3.3@7.96MHz	10,5	12@7.96MHz	90	1.80	300
FHW0805UF3R9□ST	3.9@7.96MHz	10,5	12@7.96MHz	90	1.95	280
FHW0805UF4R7□ST	4.7@7.96MHz	10,5	12@7.96MHz	85	2.05	250
FHW0805UF5R6□ST	5.6@7.96MHz	10,5	12@7.96MHz	70	2.30	240
FHW0805UF6R8□ST	6.8@7.96MHz	10,5	12@7.96MHz	55	2.60	220
FHW0805UF7R5□ST	7.5@7.96MHz	10,5	12@7.96MHz	55	2.80	210
FHW0805UF8R2□ST	8.2@7.96MHz	10,5	12@7.96MHz	50	3.00	180
FHW0805UF100□ST	10@2.52MHz	10,5	10@2.52MHz	30	3.20	150
FHW0805UF120□ST	12@2.52MHz	10,5	10@2.52MHz	17	3.50	110
FHW0805UF150□ST	15@2.52MHz	10,5	10@2.52MHz	16	4.20	100
FHW0805UF180□ST	18@2.52MHz	10,5	10@2.52MHz	15	4.50	95
FHW0805UF220□ST	22@2.52MHz	10,5	10@2.52MHz	14	6.00	80

### 1008IF Series

PartNumber	Inductance ( $\mu$ H)	Tolerance (%)	Q (min)	SRF(MHz) Min	Rdc( $\Omega$ ) Max	Idc( mA) Max
FHW1008IF1R0□ST	1.0@25.2MHz	10,5	18@25.2MHz	300	0.55	580
FHW1008IF1R2□ST	1.2@7.96MHz	10,5	18@7.96MHz	250	0.75	550
FHW1008IF1R5□ST	1.5@7.96MHz	10,5	18@7.96MHz	230	0.85	400
FHW1008IF1R8□ST	1.8@7.96MHz	10,5	18@7.96MHz	168	0.95	320
FHW1008IF2R2□ST	2.2@7.96MHz	10,5	18@7.96MHz	150	1.30	315
FHW1008IF2R7□ST	2.7@7.96MHz	10,5	18@7.96MHz	100	1.40	300
FHW1008IF3R3□ST	3.3@7.96MHz	10,5	18@7.96MHz	80	1.50	280
FHW1008IF3R9□ST	3.9@7.96MHz	10,5	18@7.96MHz	60	1.55	250
FHW1008IF4R7□ST	4.7@7.96MHz	10,5	18@7.96MHz	50	1.75	210
FHW1008IF5R6□ST	5.6@7.96MHz	10,5	15@7.96MHz	40	1.90	190
FHW1008IF6R8□ST	6.8@7.96MHz	10,5	15@7.96MHz	35	2.00	175
FHW1008IF7R5□ST	7.5@7.96MHz	10,5	15@7.96MHz	30	2.10	170
FHW1008IF8R2□ST	8.2@7.96MHz	10,5	15@7.96MHz	25	2.20	160
FHW1008IF100□ST	10@2.52MHz	10,5	12@2.52MHz	25	2.50	155
FHW1008IF120□ST	12@2.52MHz	10,5	12@2.52MHz	20	2.60	145
FHW1008IF150□ST	15@2.52MHz	10,5	12@2.52MHz	20	3.00	130
FHW1008IF180□ST	18@2.52MHz	10,5	12@2.52MHz	20	3.00	130
FHW1008IF220□ST	22@2.52MHz	10,5	12@2.52MHz	18	3.90	105
FHW1008IF270□ST	27@2.52MHz	10,5	12@2.52MHz	10	4.00	100
FHW1008IF330□ST	33@2.52MHz	10,5	10@2.52MHz	8	4.80	85
FHW1008IF390□ST	39@2.52MHz	10,5	10@2.52MHz	7	5.00	80
FHW1008IF470□ST	47@2.52MHz	10,5	10@2.52MHz	7	5.70	60
FHW1008IF560□ST	56@2.52MHz	10,5	10@2.52MHz	6.5	6.00	55
FHW1008IF680□ST	68@2.52MHz	10,5	10@2.52MHz	6.5	6.70	50

## 繞線型片式電感器 WIRE WOUND CHIP INDUCTORS

### 1008IF Series

PartNumber	Inductance (μH)	Tolerance (%)	Q (min)	SRF(MHz) Min	Rdc(Ω) Max	Idc(mA) Max
FHW1008IF820□ST	82@2.52MHz	10,5	10@2.52MHz	6.5	7.50	45
FHW1008IF101□ST	100@0.796MHz	10,5	8@0.796MHz	4.5	11.0	40
FHW1008IF121□ST	120@0.796MHz	10,5	8@0.796MHz	3	13.0	30
FHW1008IF151□ST	150@0.796MHz	10,5	8@0.796MHz	3	15.0	25
FHW1008IF221□ST	220@0.796MHz	10	8@0.796MHz	2.5	18.0	20

### 1210IF Series

PartNumber	Inductance (μH)	Tolerance (%)	Q (min)	SRF(MHz) Min	Rdc(Ω) Max	Idc(mA) Max
FHW1210IF1R0□ST	1.0@7.96MHz	10,5	20@7.96MHz	220	0.3	450
FHW1210IF1R2□ST	1.2@7.96MHz	10,5	20@7.96MHz	210	0.3	450
FHW1210IF1R5□ST	1.5@7.96MHz	10,5	20@7.96MHz	200	0.4	450
FHW1210IF1R8□ST	1.8@7.96MHz	10,5	20@7.96MHz	195	0.5	450
FHW1210IF2R2□ST	2.2@7.96MHz	10,5	20@7.96MHz	175	0.6	450
FHW1210IF2R7□ST	2.7@7.96MHz	10,5	20@7.96MHz	120	0.7	420
FHW1210IF3R3□ST	3.3@7.96MHz	10,5	20@7.96MHz	80	1.1	380
FHW1210IF3R9□ST	3.9@7.96MHz	10,5	20@7.96MHz	75	1.2	360
FHW1210IF4R7□ST	4.7@7.96MHz	10,5	18@7.96MHz	60	1.3	350
FHW1210IF5R6□ST	5.6@7.96MHz	10,5	18@7.96MHz	50	2.0	320
FHW1210IF6R8□ST	6.8@7.96MHz	10,5	18@7.96MHz	35	1.5	310
FHW1210IF8R2□ST	8.2@7.96MHz	10,5	18@7.96MHz	35	1.6	305
FHW1210IF100□ST	10@2.52MHz	10,5	15@2.52MHz	30	1.0	300
FHW1210IF120□ST	12@2.52MHz	10,5	15@2.52MHz	25	1.2	265
FHW1210IF150□ST	15@2.52MHz	10,5	15@2.52MHz	22	2.0	225
FHW1210IF180□ST	18@2.52MHz	10,5	15@2.52MHz	22	2.1	210
FHW1210IF220□ST	22@2.52MHz	10,5	15@2.52MHz	20	2.4	200
FHW1210IF270□ST	27@2.52MHz	10,5	15@2.52MHz	18	2.7	180
FHW1210IF330□ST	33@2.52MHz	10,5	15@2.52MHz	15	2.9	160
FHW1210IF390□ST	39@2.52MHz	10,5	15@2.52MHz	16	4.7	150
FHW1210IF470□ST	47@2.52MHz	10,5	15@2.52MHz	10	5.2	140
FHW1210IF560□ST	56@2.52MHz	10,5	15@2.52MHz	8.0	5.6	125
FHW1210IF680□ST	68@2.52MHz	10,5	12@2.52MHz	5.0	4.7	110
FHW1210IF820□ST	82@2.52MHz	10,5	12@2.52MHz	5.0	5.6	100
FHW1210IF101□ST	100@0.796MHz	10,5	10@0.796MHz	5.0	6.8	95
FHW1210IF121□ST	120@0.796MHz	10,5	10@0.796MHz	4.0	7.9	85
FHW1210IF151□ST	150@0.796MHz	10,5	10@0.796MHz	4.0	9.0	80
FHW1210IF181□ST	180@0.796MHz	10,5	8@0.796MHz	3.0	14.5	70
FHW1210IF221□ST	220@0.796MHz	10,5	8@0.796MHz	2.6	16.5	65
FHW1210IF271□ST	270@0.796MHz	10	8@0.796MHz	2.5	18.0	60
FHW1210IF331□ST	330@0.796MHz	10	8@0.796MHz	2.3	19.0	55
FHW1210IF391□ST	390@0.796MHz	10	8@0.796MHz	2.2	21.5	45
FHW1210IF471□ST	470@0.796MHz	10	8@0.796MHz	2.0	22.5	40
FHW1210IF561□ST	560@0.796MHz	10	6@0.796MHz	1.5	28.0	30

## 1812IF Series

PartNumber	Inductance ( $\mu$ H)	Tolerance (%)	Q(min)	SRF(MHz) Min	Rdc( $\Omega$ ) Max	Idc( mA) Max
FHW1812IF1R0□ST	1.0@7.96MHz	10,5	25@7.96MHz	200	0.22	1000
FHW1812IF1R2□ST	1.2@7.96MHz	10,5	25@7.96MHz	200	0.35	1000
FHW1812IF1R5□ST	1.5@7.96MHz	10,5	25@7.96MHz	180	0.32	1000
FHW1812IF1R8□ST	1.8@7.96MHz	10,5	25@7.96MHz	160	0.35	950
FHW1812IF2R2□ST	2.2@7.96MHz	10,5	25@7.96MHz	150	0.37	900
FHW1812IF2R7□ST	2.7@7.96MHz	10,5	25@7.96MHz	145	0.37	850
FHW1812IF3R3□ST	3.3@7.96MHz	10,5	25@7.96MHz	140	0.48	800
FHW1812IF3R9□ST	3.9@7.96MHz	10,5	25@7.96MHz	135	0.60	750
FHW1812IF4R7□ST	4.7@7.96MHz	10,5	25@7.96MHz	120	1.00	700
FHW1812IF5R6□ST	5.6@7.96MHz	10,5	25@7.96MHz	110	0.55	650
FHW1812IF6R8□ST	6.8@7.96MHz	10,5	25@7.96MHz	80	0.80	600
FHW1812IF8R2□ST	8.2@7.96MHz	10,5	20@7.96MHz	70	0.85	600
FHW1812IF100□ST	10@2.52MHz	10,5	20@2.52MHz	60	1.0	550
FHW1812IF120□ST	12@2.52MHz	10,5	20@2.52MHz	55	1.1	550
FHW1812IF150□ST	15@2.52MHz	10,5	18@2.52MHz	35	1.2	500
FHW1812IF180□ST	18@2.52MHz	10,5	18@2.52MHz	29	1.2	500
FHW1812IF220□ST	22@2.52MHz	10,5	18@2.52MHz	20	1.3	450
FHW1812IF270□ST	27@2.52MHz	10,5	18@2.52MHz	20	1.5	400
FHW1812IF330□ST	33@2.52MHz	10,5	18@2.52MHz	18	1.7	350
FHW1812IF390□ST	39@2.52MHz	10,5	18@2.52MHz	14	1.8	350
FHW1812IF470□ST	47@2.52MHz	10,5	16@2.52MHz	10	2.0	300
FHW1812IF560□ST	56@2.52MHz	10,5	16@2.52MHz	10	2.2	290
FHW1812IF680□ST	68@2.52MHz	10,5	12@2.52MHz	5.4	2.4	260
FH1812IF820□ST	82@2.52MHz	10,5	12@2.52MHz	5.2	2.8	240
FHW1812IF101□ST	100@0.796MHz	10,5	12@0.796MHz	4.0	3.0	220
FHW1812IF121□ST	120@0.796MHz	10,5	10@0.796MHz	3.3	3.3	220
FHW1812IF151□ST	150@0.796MHz	10,5	10@0.796MHz	3.0	3.7	200
FHW1812IF181□ST	180@0.796MHz	10,5	10@0.796MHz	3.0	4.5	200
FHW1812IF221□ST	220@0.796MHz	10,5	10@0.796MHz	2.5	8.0	170
FHW1812IF271□ST	270@0.796MHz	10,5	10@0.796MHz	2.2	8.5	160
FHW1812IF331□ST	330@0.796MHz	10	10@0.796MHz	2.0	9.0	150
FHW1812IF391□ST	390@0.796MHz	10	10@0.796MHz	1.8	9.5	130
FHW1812IF471□ST	470@0.796MHz	10	8@0.796MHz	1.6	12.0	120
FHW1812IF561□ST	560@0.796MHz	10	8@0.796MHz	1.5	12.5	110
FHW1812IF681□ST	680@0.796MHz	10	8@0.796MHz	1.5	14.0	100
FHW1812IF751□ST	750@0.796MHz	10	8@0.796MHz	1.5	14.5	95
FHW1812IF821□ST	820@0.796MHz	10	8@0.796MHz	1.5	15.0	95
FHW1812IF102□ST	1000@0.252MHz	10	6@0.252MHz	1.4	16.5	90

特性曲線  
CHARACTERISTIC CURVE

- 頻率特性  
FREQUENCY CHARACTERISTIC

Ls VS FREQ.

Q VS FREQ.

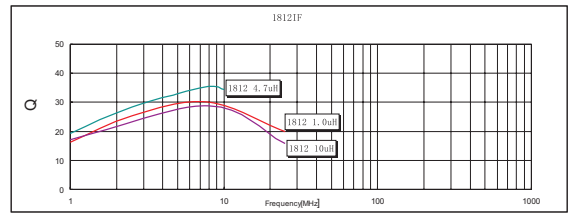
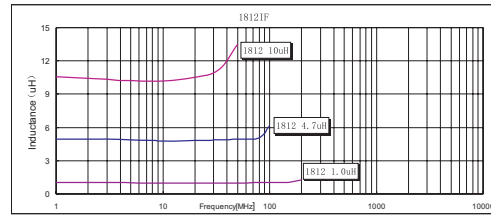
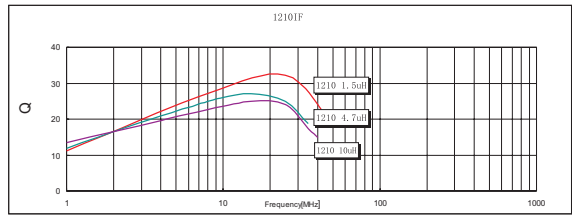
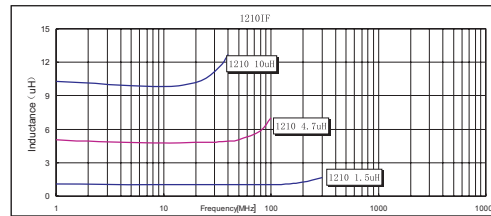
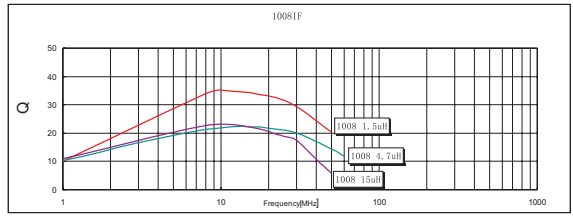
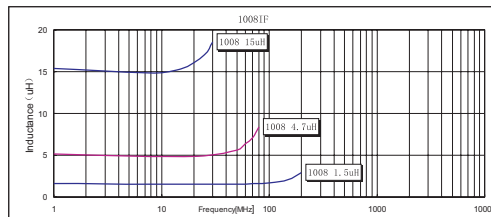
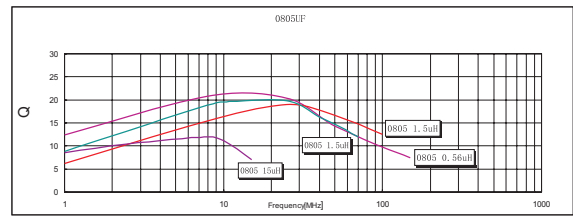
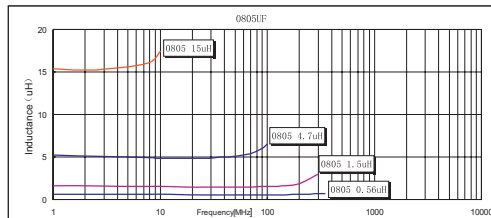
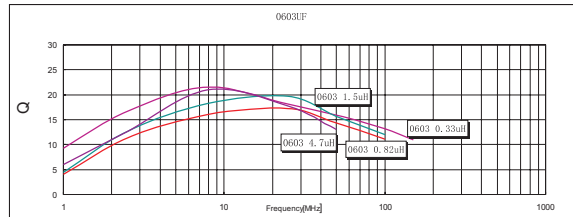
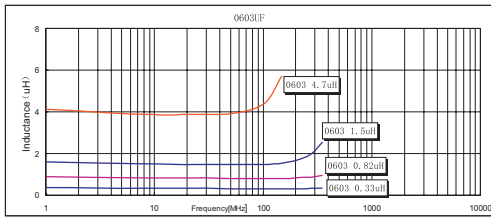

## ■ 電性能測試 Electrical Specification Test

序號 NO.	項目 Item	詳細說明Specified value	試驗方法Test methods
		0402UC、0603UC、0805UC、1008UC、1210HC	
1	工作溫度 Operating Temp. Range	-40°C~+85°C	
2	儲存溫度 Storage Temp. Range	-10°C~+40°C	
3	額定電流 Rated Current	20~1000mA(Max)	測試設備: CH102+1320 or HP4284A+HP42841A Test Equipment: CH102+1320 or HP4284A+HP42841A
4	電感量 Inductance	0.1~1000 $\mu$ H	測試頻率: 0.252~25.2MHz Test Frequency: 0.252~25.2MHz 測試設備: HP4285A or HP4286A +16193A or 16197A Test Equipment: HP4285A or HP4286A+16193A or 16197A
5	品質因數 Q	6~25(min)	測試頻率: 0.252~25.2MHz Test Frequency: 0.252~25.2MHz 測試設備: HP4285A or HP4286A +16193A or 16197A Test Equipment: HP4285A or HP4286A+16193A or 16197A
6	直流電阻 Rdc	0.13~28 $\Omega$ (Max)	測試設備: HP4263B or HP4286A Test Equipment: HP4263B or HP4286A
7	自諧頻率 SRF	1.4~1150MHz(Min)	測試設備: HP8720D Test Equipment: HP8720D

■ 可靠性測試 Reliability Test

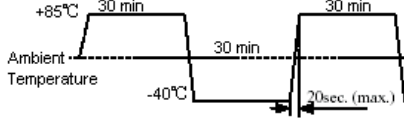
序號 NO.	項目 Item	詳細說明Specified value	試驗方法Test methods
		0402UC、0603UC、0805UC、1008UC、1210HC	
1	可焊性 Solderability	外觀不發生變化; There shall be no case deformation or change in appearance; 至少90%端電極表面被焊錫覆蓋。 At least 90% of terminal electrode is covered by new solder	焊接溫度: : 245±5°C Solder temp.: 245±5°C 浸入時間: 5±1秒 Duration:5±1S
2	耐焊性 Resistance to soldering	外觀不發生變化; There shall be no case deformation or change in appearance; 感量變化不超過±5%; Inductance shall not change more than ±5%; Q值變化不超過±10%。 Q shall not change more than±10%.	焊接溫度: : 260±5°C Solder temp.: 260±5°C 浸入時間: 10±1秒 Duration:10±1S
3	溫度循環 Thermal shock		溫度: -40°C, 60±2分鐘 +85°C, 60±2分鐘 emperature:-40°C for 60±2min +85°C for 60±2min 循環次數: 10 Number of cycles:10  
4	高溫 High Temperature storage		溫度: +85°C±2°C Temperature:+85°C±2°C 時間: 96±2小時 Time: 96±2h
5	低溫 Low Temperature storage	溫度: -55°C±2°C Temperature:-55°C±2°C 時間: 96±2小時 Time: 96±2h	
6	恒定濕熱 Damp heat (steady state)	外觀不發生變化; There shall be no case deformation or change in appearance; 感量變化不超過±5%; Inductance shall not change more than ±5%; Q值變化不超過±10%。 Q shall not change more than±10%.	濕度: 90~95% RH Humidity:90 to 95% RH 溫度: 50±2°C Temperature:50±2°C 測試時間: 100±2小時 Duration: 100±2h
7	振動 Vibration		頻率: 10~55~10Hz Frequency: 10 to 55 to 10Hz 振幅: 1.5mm Amplitude:1.5mm X、Y、Z方向的時間: 每方向1小時45分鐘 Directions:1 hours 45minutes each in X,Y,Z direction.

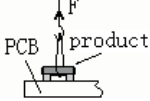
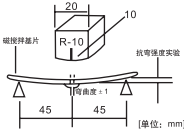

## ■ 可靠性測試 Reliability Test

序號 NO.	項目 Item	詳細說明Specified value	試驗方法Test methods
		0603UF、0805UF、1008IF、1210IF、1812IF	
8	端電極強度 Terminal Strength (Pull of Test)	0603UF: $\geq 0.9\text{Kg}$ ; 0805UF: $\geq 1.3\text{Kg}$ ; 1008IF、1210IF、1812IF: $\geq 2\text{Kg}$ .	
9	跌落 Drop	外觀不發生變化; There shall be no case deformation or change in appearance; 感量變化不超過 $\pm 5\%$ ; Inductance shall not change more than $\pm 5\%$ ; Q值變化不超過 $\pm 10\%$ . Q shall not change more than $\pm 10\%$ .	從高度為1米的空中自由落到混凝土地板重複10次。 Dropped 10 times on a concrete floor from a height of 1m.
10	抗彎強度 Flextrue strength	外觀不發生變化; There shall be no case deformation or change in appearance; 感量變化不超過 $\pm 5\%$ ; Inductance shall not change more than $\pm 5\%$ ; Q值變化不超過 $\pm 10\%$ . Q shall not change more than $\pm 10\%$ .	Flexure:20mm Test board:Glass -Epoxy board Thickness:0.8mm 
11	過載 Over Loading	外觀不發生變化; Appearance:No Damage ; 電感無開路。 Inductors shall not have a open winding.	施加2倍額定電流，電流誤差為 $\pm 2\%$ ，保持5分鐘。 Provide 2 times the rated current of direct current between inductor terminals, Direct current error 5%, and for 5 minutes.
12	壽命 Life	外觀不發生變化; There shall be no case deformation or change in appearance; 感量變化不超過 $\pm 5\%$ ; Inductance shall not change more than $\pm 5\%$ ; Q值變化不超過 $\pm 10\%$ . Q shall not change more than $\pm 10\%$ .	溫度: $85\pm 2^\circ\text{C}$ Temperature: $85\pm 2^\circ\text{C}$ 測試時間: 1000小時 Duration: 1000h 施加額定電流 Applied current: Rated current.

■ 包裝 Packaging Style

● 載帶 Tape

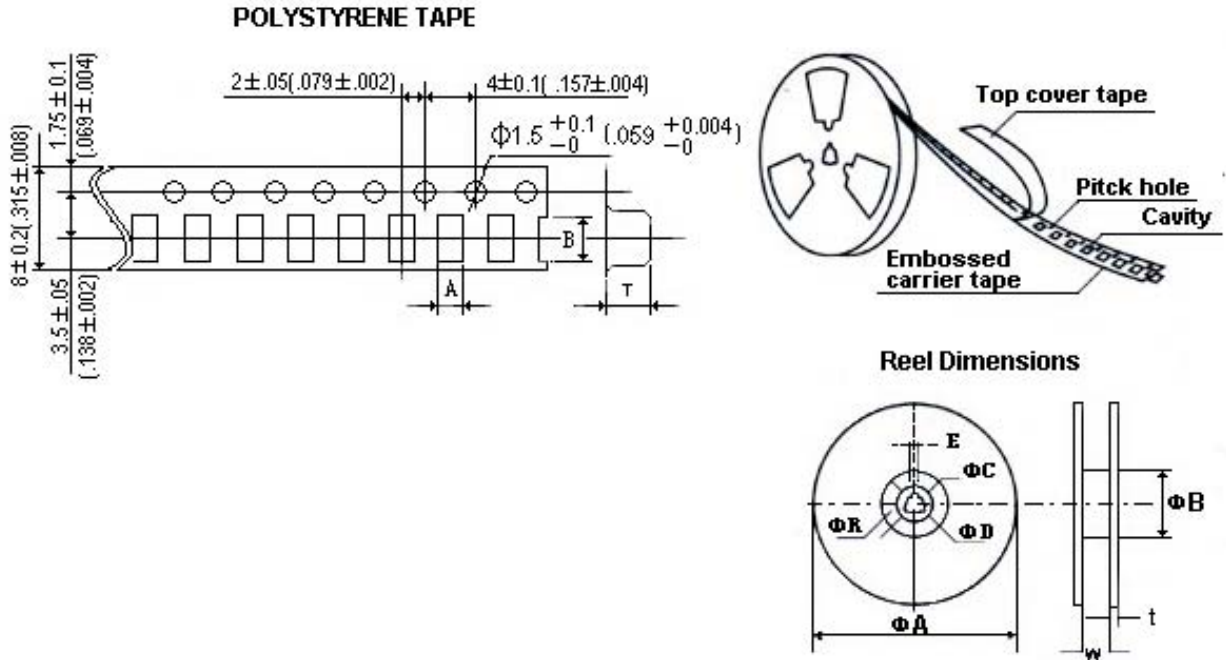

Unit(mm)

型號Type	A	B	T	
膠帶 Polystyrene tape	0603	1.18	1.85	0.95
	0805	1.85	2.45	1.50
	1008	2.73	2.90	2.34
	1210	2.96	3.60	2.40
	1812	3.22	4.82	2.98

Unit(mm)

型號Type	ΦA	ΦB	ΦC	ΦD	E	W	t	R
0603 1210	178	60	13	21	2	10	2	1
1812	330	75	13	23	2	12	2	1

● 剝離力Peeling off force

要求Pull strength

0603~1210 : 20g ~80g

1812 : 20g ~100g

蓋帶剝離速度Speed of peeling off:

300mm/min ± 10%

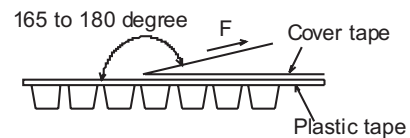

● 包裝數量

Packaging Quantity

規格Dimension	0603	0805	1008	1210	1812
每卷數量Per Reel (pcs)	4000	3000	2000	2000	2000
每盒數量Per Box (pcs)	20000	15000	10000	10000	8000