

Features

- Supply Voltage: 3V to 36V
- Low Supply Current: Maximum 1000μA per channel
- Differential Input Voltage Range to Supply Rail, can Work as Comparator
- Input Rail to -Vs, Rail to Rail Output
- Fast Response: 3.5 MHz Bandwidth, 15V/μs Slew Rate, 100ns Overload Recovery
- Low Offset Voltage:
 - ±2mV Maximum at 25°C,
 - ±2.5mV Maximum at -40°C to 85°C
 - ±3mV Maximum at -40°C to 125°C
- Very Low THD+N: 0.0005% at Gain = 1, 1kHz
- Excellent EMIRR: 60dB at 900MHz
- 2KV HBM, 1KV CDM, 150mA Latch Up
- -40°C to 125°C Operation Temperature Range

Description

The TP226X series amplifiers are newest high supply voltage amplifiers with low offset, low power and stable high frequency response. They incorporate 3PEAK's proprietary and patented design techniques to achieve very good AC performance with 3.5MHz bandwidth, 15V/μs slew rate and low distortion while drawing only typical 700μA of quiescent current per amplifier. The input common-mode voltage range extends to V-, and the outputs swing rail-to-rail. The TP226X family can be used as plug-in replacements for many commercially available op-amps to reduce power and improve input/output range and performance.

The combination of features makes the TP226X ideal choices for industrial control, motor control and portable audio amplification, sound ports, and other consumer audio.

Applications

- Sensor Interface
- Motor Control
- Industrial Control
- Audio

Pin Configuration

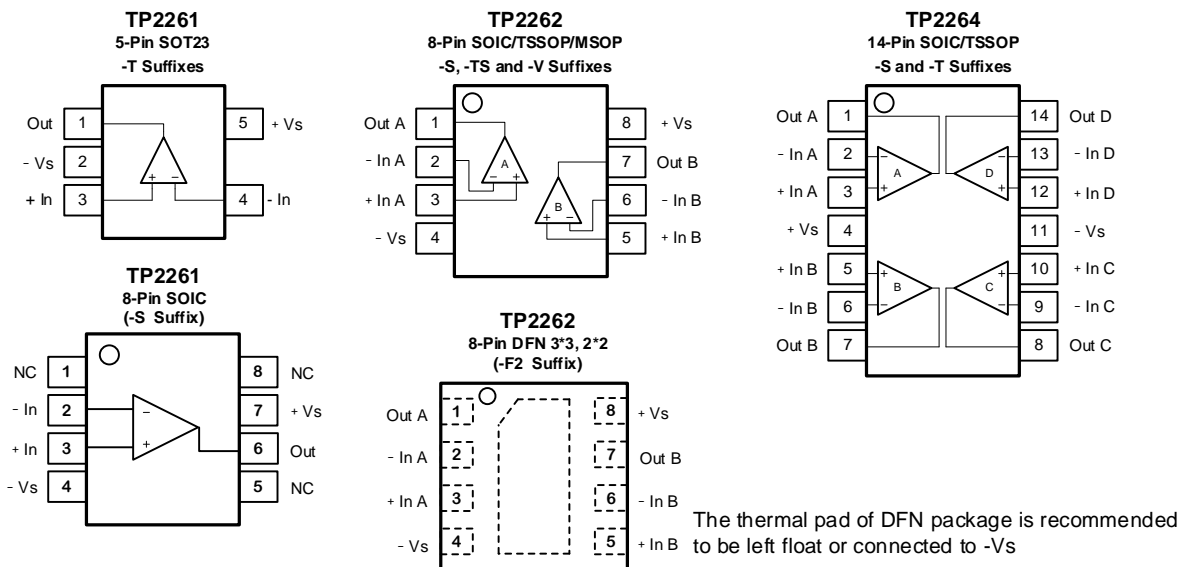

Table of Contents

Features	1
Applications.....	1
Description.....	1
Pin Configuration	1
Table of Contents	2
Revision History	2
Order Information.....	3
Absolute Maximum Ratings ^{Note 1}	4
ESD Rating.....	4
Thermal Information	4
Electrical Characteristics	5
Typical Performance Characteristics	7
Tape and Reel Information	12
Package Outline Dimensions.....	13
SOT23-5.....	13
SOIC-8	13
TSSOP-8.....	14
MSOP-8	14
DFN8 2*2	15
DFN8 3*3	16
SOIC-14	17
TSSOP-14.....	17

Revision History

Date	Revision	Notes
2017/12/21	Rev.Pre	Pre-Release Version
2018/9/9	Rev.0	Initial Version
2018/12/21	Rev.0.01	Add New Part Number: TP2262L1-TSR, TP2261L1-TR. Update mark information: Add "TP" before "226" on 8-Pin SOIC and 14-Pin SOIC Package.
2019/2/15	Rev.0.02	Add New Part Number: TP2262-F2R. Update Package Outline Dimensions.
2019/3/30	Rev.0.03	Update date code information. Update Package Outline Dimensions.
2019/5/30	Rev.0.04	Add Figure 29: Crosstalk vs. Frequency
2020/9/24	Rev.A	Update the description of Absolute Maximum Ratings: "Maximum Junction Temperature" -> "Maximum Operating Junction Temperature" Add Part Number: TP2262-FR; Remove Part Number: TP2261L1-TR
2021/4/10	Rev.A.1	Remove Part Number: TP2262L1-SR, TP2262L1-TSR, TP2264L1-TSR

Order Information

Order Number	Operating Temperature Range	Package	Marking Information	MSL	Transport Media, Quantity
TP2261-SR	-40 to 125°C	8-Pin SOIC	2261 XXXX <small>Note 1</small>	3	Tape and Reel, 4000
TP2261-TR	-40 to 125°C	5-Pin SOT23	226XX <small>Note 1</small>	3	Tape and Reel, 3000
TP2262-SR	-40 to 125°C	8-Pin SOIC	TP2262 XXXX <small>Note 1</small>	3	Tape and Reel, 4000
TP2262-FR	-40 to 125°C	8-Pin DFN 2*2	226 XXXX <small>Note 1</small>	3	Tape and Reel, 3000
TP2262-F2R	-40 to 125°C	8-Pin DFN 3*3	2262 XXXX <small>Note 1</small>	3	Tape and Reel, 4000
TP2262-TSR	-40 to 125°C	8-Pin TSSOP	2262 XXXX <small>Note 1</small>	3	Tape and Reel, 3000
TP2262-VR	-40 to 125°C	8-Pin MSOP	2262 XXXX <small>Note 1</small>	3	Tape and Reel, 3000
TP2264-SR	-40 to 125°C	14-Pin SOIC	TP2264 XXXX <small>Note 1</small>	3	Tape and Reel, 2500
TP2264-TR	-40 to 125°C	14-Pin TSSOP	2264 XXXX <small>Note 1</small>	3	Tape and Reel, 3000

Note 1: "XX" or "XXXX" identify the manufacture site and date code information, "L" means MSL1 product.

Absolute Maximum Ratings ^{Note 1}

Parameters	Rating
Supply Voltage, (+V _S)– (-V _S)	40 V
Input Voltage	(-V _S) – 0.3 to (+V _S) + 0.3
Differential Input Voltage	(+V _S) - (-V _S)
Input Current: +IN, –IN ^{Note 2}	\pm 10mA
Output Short-Circuit Duration ^{Note 3}	Infinite
Maximum Junction Temperature	150°C
Operating Temperature Range	–40 to 125°C
Storage Temperature Range	–65 to 150°C
Lead Temperature (Soldering, 10 sec)	260°C

Note 1: Stresses beyond those listed under Absolute Maximum Ratings may cause permanent damage to the device. Exposure to any Absolute Maximum Rating condition for extended periods may affect device reliability and lifetime.

Note 2: The inputs are protected by ESD protection diodes to each power supply. If the input extends more than 300mV beyond the power supply, the input current should be limited to less than 10mA.

Note 3: A heat sink may be required to keep the junction temperature below the absolute maximum. This depends on the power supply voltage and how many amplifiers are shorted. Thermal resistance varies with the amount of PC board metal connected to the package. The specified values are for short traces connected to the leads.

ESD Rating

Symbol	Parameter	Condition	Minimum Level	Unit
HBM	Human Body Model ESD	ANSI/ESDA/JEDEC JS-001	2	kV
CDM	Charged Device Model ESD	ANSI/ESDA/JEDEC JS-002	1	kV

Thermal Information

Package Type	θ_{JA}	θ_{JC}	Unit
5-Pin SOT23	250	81	°C/W
8-Pin SOIC	158	43	°C/W
8-Pin TSSOP	191	44	°C/W
8-Pin DFN 3*3	120	50	°C/W
8-Pin MSOP	210	45	°C/W
14-Pin SOIC	120	36	°C/W
14-Pin TSSOP	180	35	°C/W

Electrical Characteristics

All test condition is $V_S = 30V$, $T_A = 25^\circ C$, $R_L = 10k\Omega$ to $V_S/2$, unless otherwise noted.

Symbol	Parameter	Conditions	T_A	Min	Typ	Max	Unit
Power Supply							
V_S	Supply Voltage Range			3		36	V
I_Q	Quiescent Current per Amplifier	$V_S = 30V$, TP2261			1000	1500	μA
			-40°C to 125°C			1700	μA
		$V_S = 5V$, TP2261			850	1300	μA
			-40°C to 125°C			1500	μA
		$V_S = 30V$, TP2262/TP2264			700	1000	μA
			-40°C to 125°C			1200	μA
$V_S = 5V$, TP2262/TP2264			600	850	μA		
	-40°C to 125°C			1000	μA		
PSRR	Power Supply Rejection Ratio	$V_S = 3V$ to 36V		95	120		dB
			-40°C to 125°C	90			dB
Input Characteristics							
V_{OS}	Input Offset Voltage	$V_S = 30V$, $V_{CM} = 0V$ to 28V		-2	0.1	2	mV
			-40°C to 85°C	-2.5		2.5	mV
			-40°C to 125°C	-3		3	mV
		$V_S = 30V$, $V_{CM} = 28.5V$		-3		3	mV
			-40°C to 125°C	-4		4	mV
		$V_S = 5V$, $V_{CM} = 2.5V$		-2	0.1	2	mV
-40°C to 125°C	-3			3	mV		
$V_{OS\ TC}$	Input Offset Voltage Drift		-40°C to 125°C		2		μV/°C
I_B	Input Bias Current				25		pA
			-40°C to 85°C		80		pA
			-40°C to 125°C		1000		pA
I_{OS}	Input Offset Current				25		pA
I_{IN}	Different Input Current	$V_S = 36V$, $V_{ID} = 36V$			10		nA
			-40°C to 125°C			100	
C_{IN}	Input Capacitance	Differential Mode			5		pF
		Common Mode			2.5		pF
A_V	Open-loop Voltage Gain			105	120		dB
			-40°C to 125°C	100			dB
V_{CMR}	Common-mode Input Voltage Range			(V-)		(V+) - 1.5	V
CMRR	Common Mode Rejection Ratio	$V_{CM} = 0V$ to 28V		105	130		dB
			-40°C to 125°C	100			dB

Output Characteristics								
V _{OH}	Output Swing from Positive Rail	R _{LOAD} = 10k Ω to V _S /2			200	300	mV	
			-40°C to 125°C			450		mV
		R _{LOAD} = 2k Ω to V _S /2			1.1	1.4		V
			-40°C to 125°C				2	
V _{OL}	Output Swing from Negative Rail	R _{LOAD} = 10k Ω to V _S /2			200	300	mV	
			-40°C to 125°C			450		mV
		R _{LOAD} = 2k Ω to V _S /2			0.8	1		V
			-40°C to 125°C				1.6	
I _{SC}	Output Short-Circuit Current			25	32		mA	
		-40°C to 85°C	20				mA	
		-40°C to 125°C	15				mA	
AC Specifications								
GBW	Gain-Bandwidth Product				3.5		MHz	
SR	Slew Rate	G = 1, 10V step			15		V/ μ s	
			Open Loop		9	15		V/ μ s
		Open Loop	-40°C to 85°C	7				V/ μ s
			-40°C to 125°C	6				V/ μ s
t _{OR}	Overload Recovery				100		ns	
t _S	Settling Time, 0.1%	G = -1, 10V step			0.8		μ s	
	Settling Time, 0.01%				1		μ s	
PM	Phase Margin	V _S = 36V, R _L =10K, C _L =100pF			60		°	
GM	Gain Margin	V _S = 36V, R _L =10K, C _L =100pF			15		dB	
Noise Performance								
E _N	Input Voltage Noise	f = 0.1Hz to 10Hz			1.7		μ V _{RMS}	
e _N	Input Voltage Noise Density	f = 1kHz			30		nV/ \sqrt Hz	
i _N	Input Current Noise	f = 1kHz			2		fA/ \sqrt Hz	
THD+N	Total Harmonic Distortion and Noise	f = 1kHz, G = 1, R _L = 10k Ω , V _{OUT} = 6V _{RMS}			0.0005		%	

Typical Performance Characteristics

$V_s = \pm 15V$, $V_{CM} = 0V$, $R_L = 10k\Omega$, unless otherwise specified.

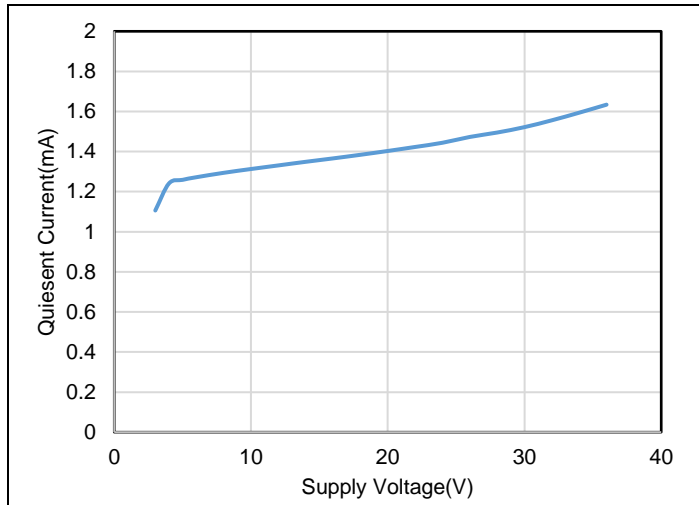

Figure 1. Quiescent Current vs. Supply Voltage, 2ch TP2262

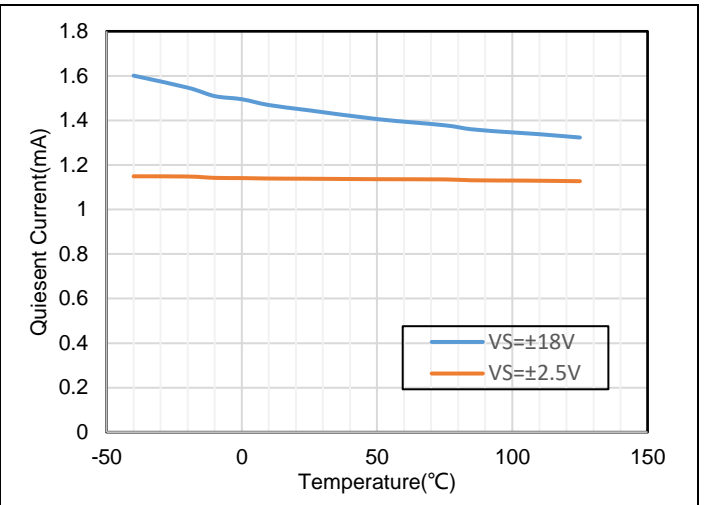

Figure 2. Quiescent Current vs. Temperature, 2ch TP2262

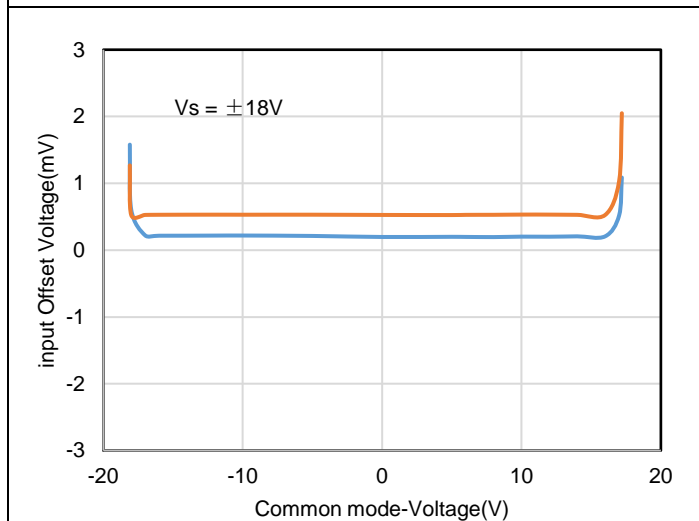

Figure 3. Offset Voltage vs. Common Mode Voltage

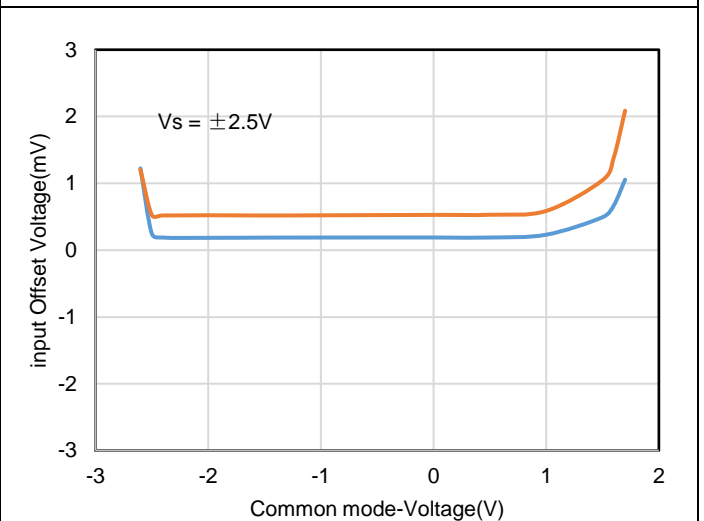

Figure 4. Offset Voltage vs. Common Mode Voltage

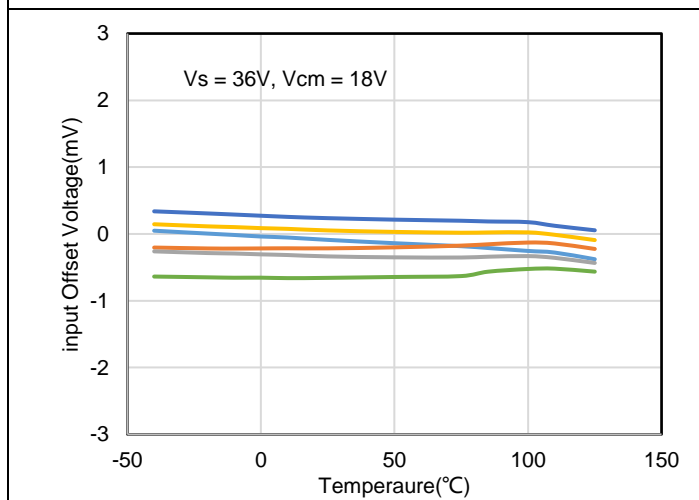

Figure 5. V_{OS} vs. Temperature

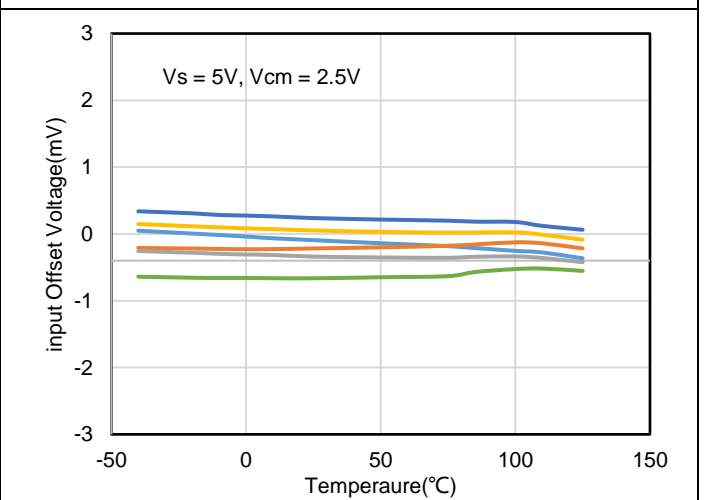

Figure 6. V_{OS} vs. Temperature

$V_s = \pm 15V$, $V_{CM} = 0V$, $R_L = 10k\Omega$, unless otherwise specified.

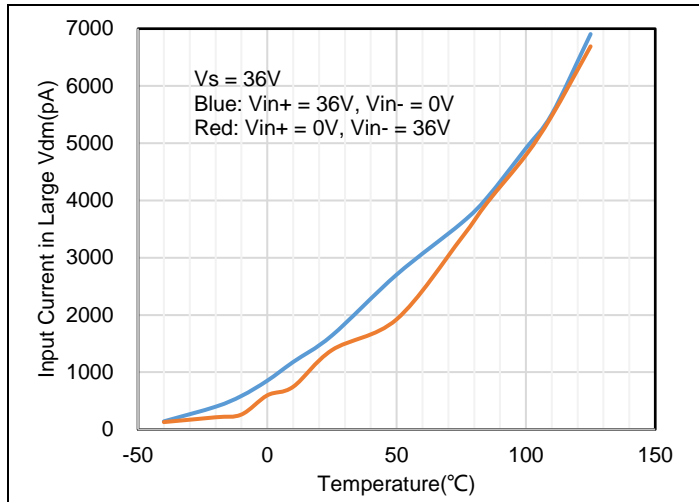

Figure 7. Input Current in Large Vdm vs. Temperature

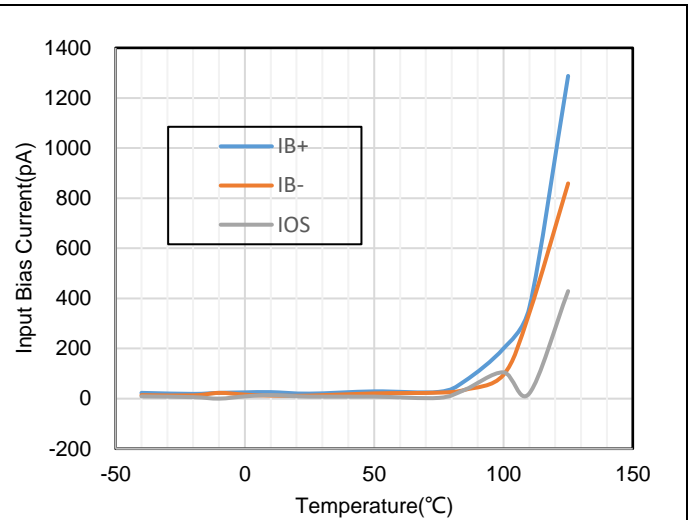

Figure 8. I_B vs. Temperature

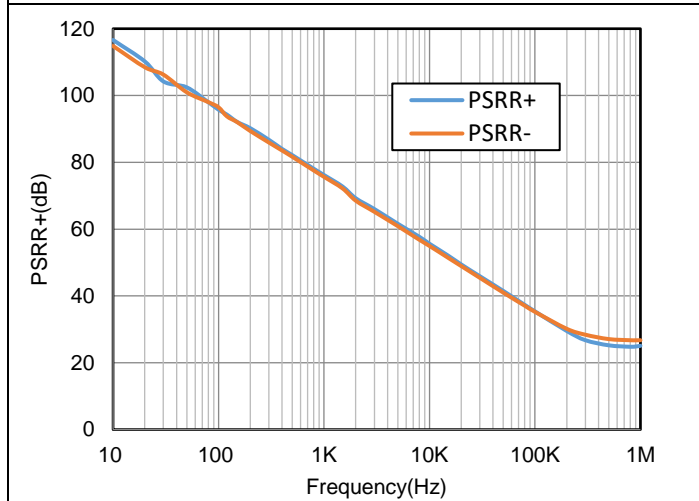

Figure 9. PSRR vs. Frequency

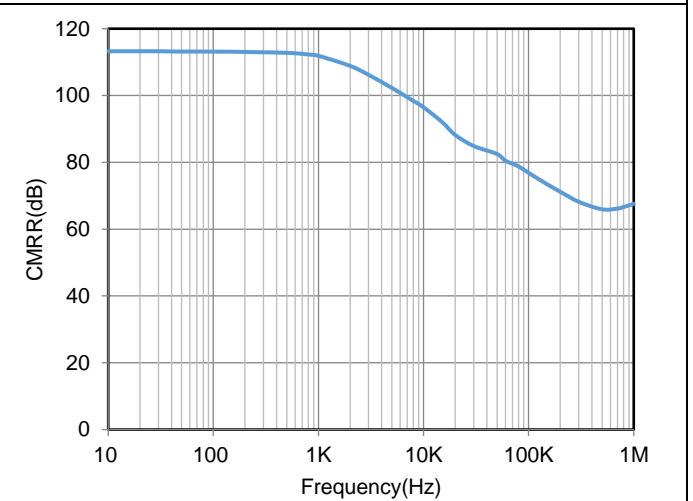

Figure 10. CMRR vs. Frequency

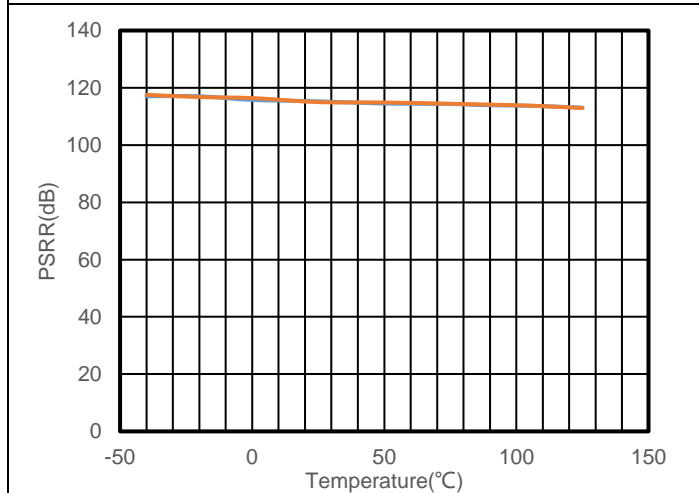

Figure 11. PSRR vs. Temperature

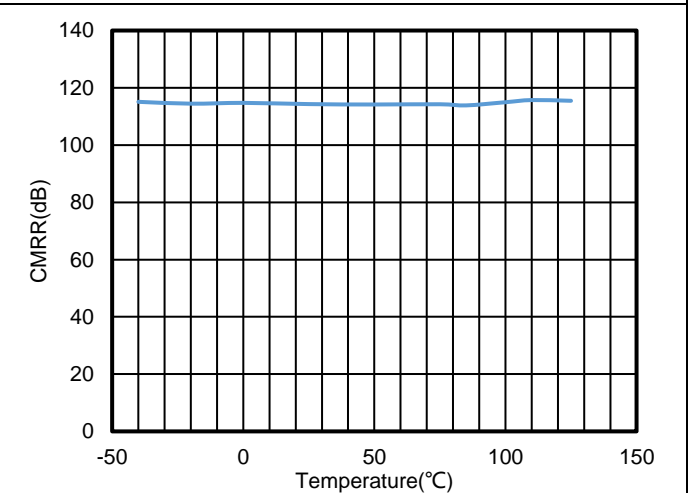

Figure 12. CMRR vs. Temperature

$V_s = \pm 15V$, $V_{CM} = 0V$, $R_L = 10k\Omega$, unless otherwise specified.

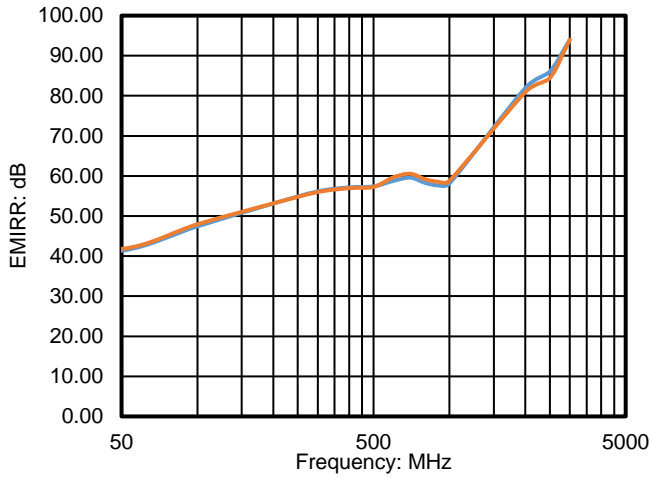

Figure 13. EMIRR+- vs. Frequency

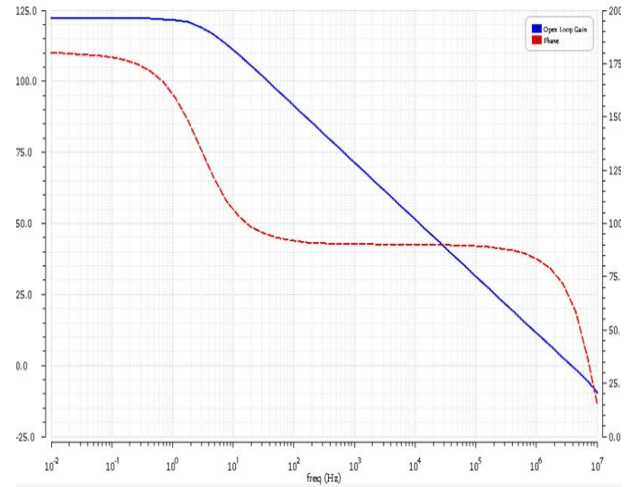

Figure 14. Open Loop Gain and Phase vs. Frequency

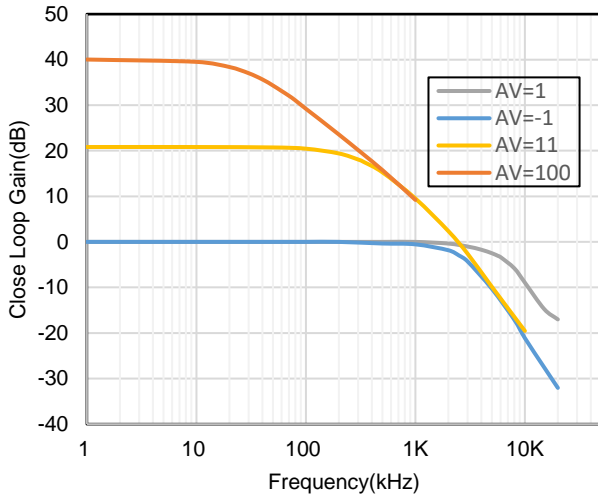
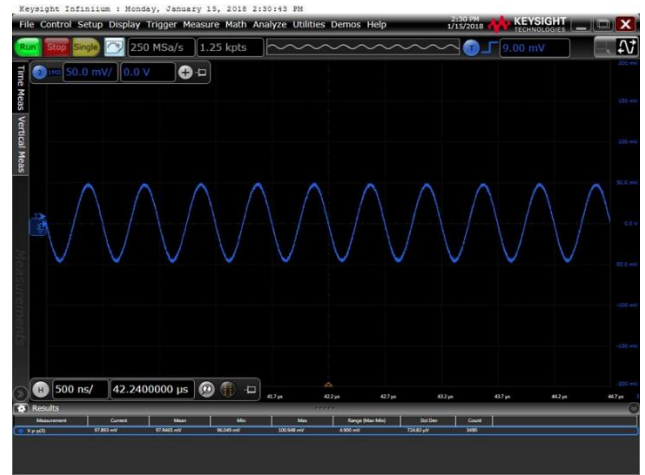

Figure 15. Close Loop Gain and Phase vs. Frequency



$V_s = \pm 1.5V$, $V_{IN} = 100mV_{PP}$, $R_L = 10K$, $C_L = 100pF$, $G = 1$

Figure 16. Waveform under 3V Supply Voltage

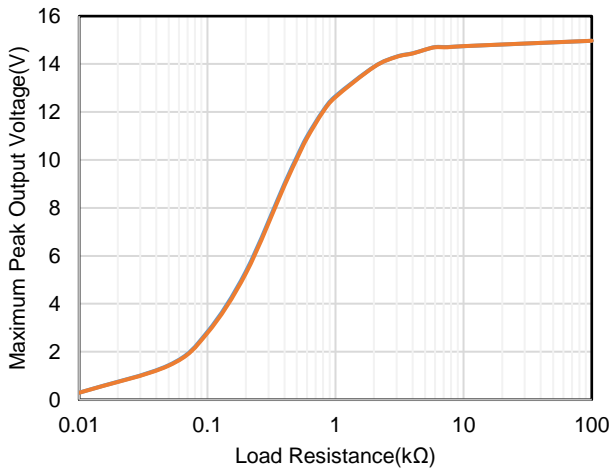

Figure 17. Maximum Peak Output Voltage vs. Load Resistance

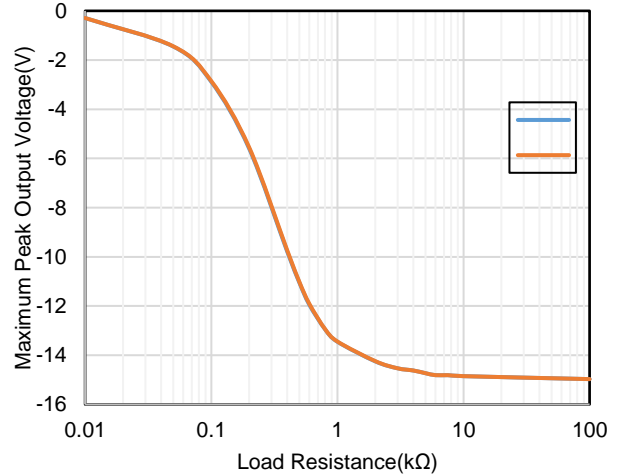

Figure 18. Maximum Peak Output Voltage vs. Load Resistance

$V_s = \pm 15V$, $V_{CM} = 0V$, $R_L = 10k\Omega$, unless otherwise specified.

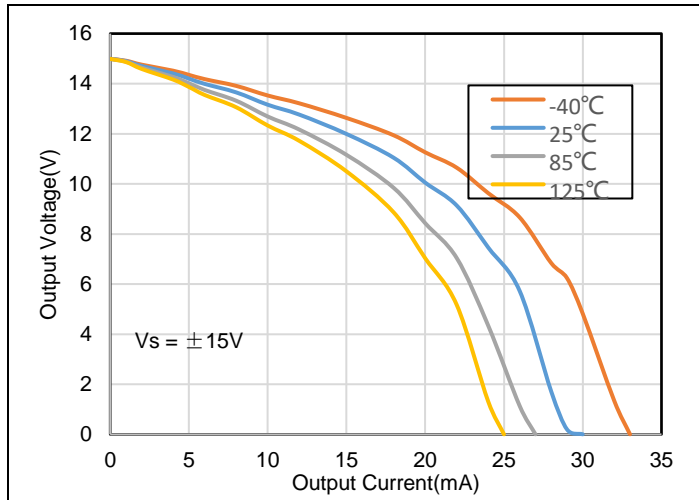

Figure 19. Positive Output Voltage vs. Output Current

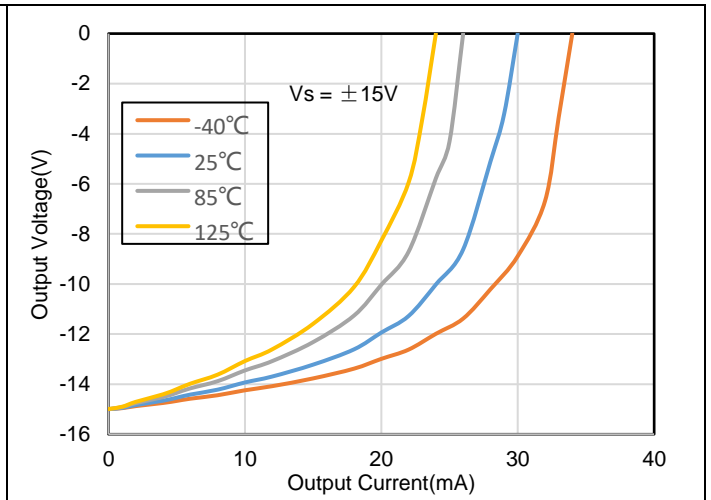

Figure 20. Negative Output Voltage vs. Output Current

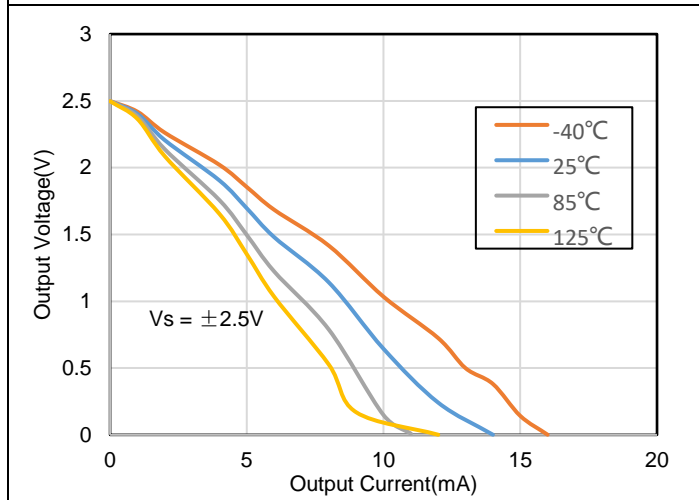

Figure 21. Positive Output Voltage vs. Output Current

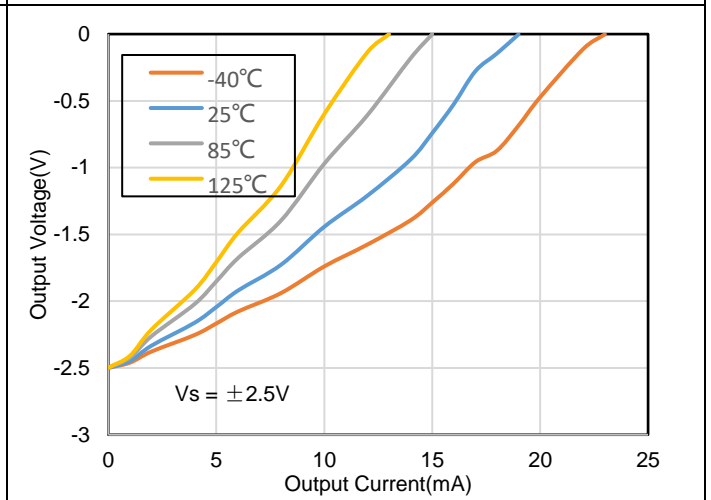

Figure 22. Negative Output Voltage vs. Output Current



Voltage: 1V/div, Time: 200ns/div
 $V_s = 5V$, $V_{IN} = 2V$, $R_L = \text{Open}$, $G = 3$
 Figure 23. Positive Overload Recovery



Voltage: 1V/div, Time: 200ns/div
 $V_s = 5V$, $V_{IN} = 2V$, $R_L = \text{Open}$, $G = 3$
 Figure 24. Negative Overload Recovery

$V_S = \pm 15V$, $V_{CM} = 0V$, $R_L = 10k\Omega$, unless otherwise specified.



Voltage: 20mV/div, Time: 100ns/div
 $V_S = \pm 15V$, $R_L = 2K$, $C_L = 100pF$, $G = 1$
 Figure 25. 100mV Signal Step Response

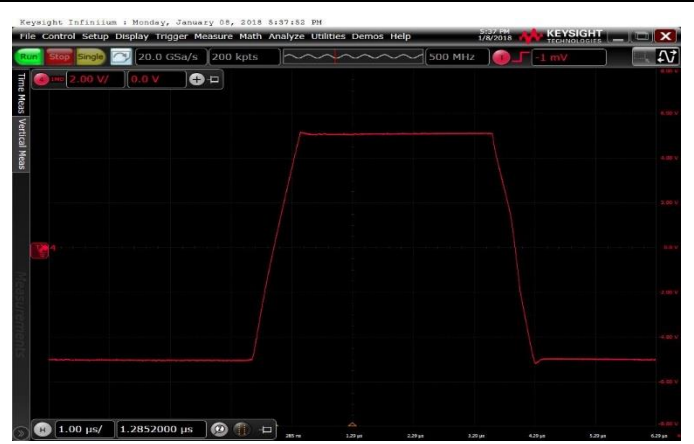

Voltage: 2V/div, Time: 1μs/div
 $V_S = \pm 15V$, $R_L = 2K$, $C_L = 100pF$, $G = 1$
 Figure 26. 10V Signal Step Response

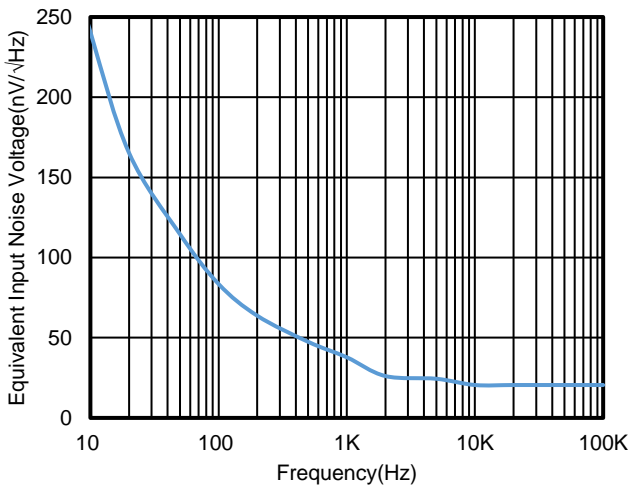

$V_S = \pm 15V$, $V_{CM} = 0V$

Figure 27. Voltage Noise Spectral Density vs. Frequency

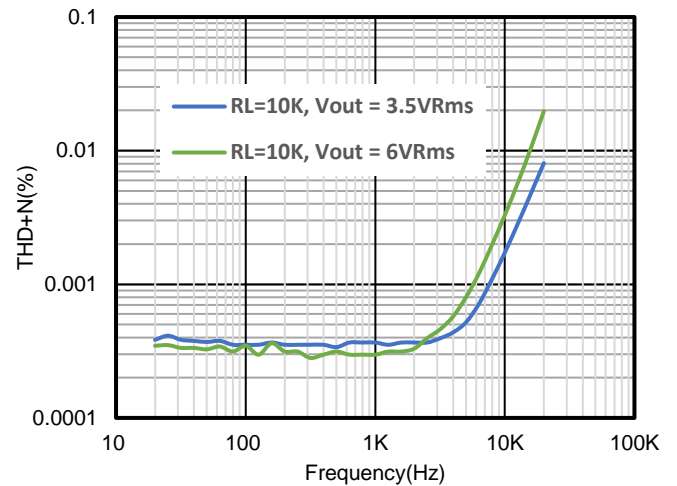

$V_S = \pm 15V$, $V_{CM} = 0V$, $G = 1$

Figure 28. THD+N vs. Frequency

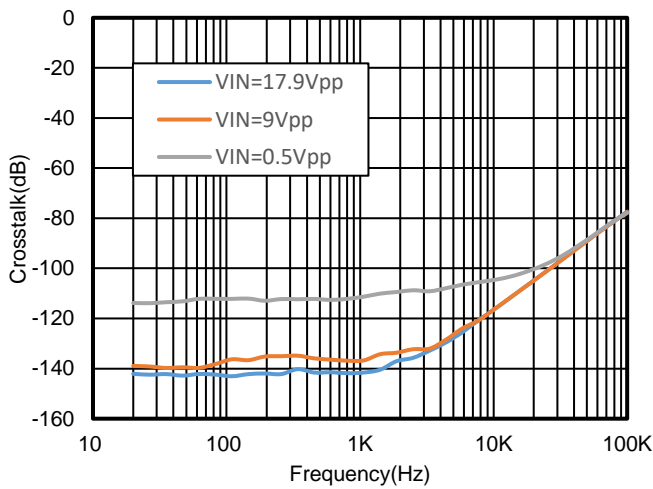

$V_S = \pm 15V$, $V_{CM} = 0V$

Figure 29. Crosstalk vs. Frequency

Tape and Reel Information

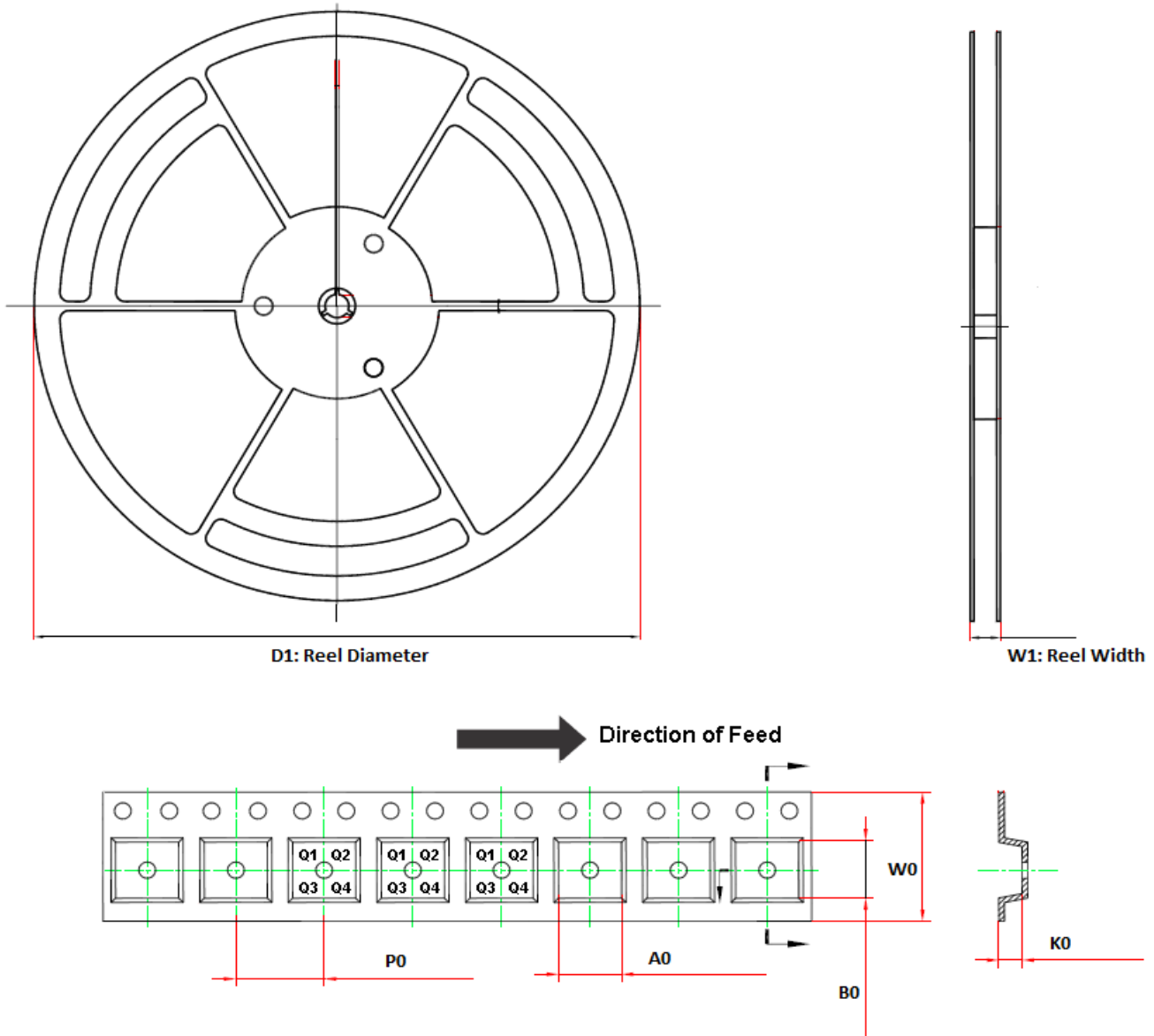

Order Number	Package	D1	W1	A0	B0	K0	P0	W0	Pin1 Quadrant
TP2261-TR	5-Pin SOT23	180.0	13.1	3.2	3.2	1.4	4.0	8.0	Q3
TP2261-SR	8-Pin SOIC	330.0	17.6	6.4	5.4	2.1	8.0	12.0	Q1
TP2262-SR	8-Pin SOIC	330.0	17.6	6.4	5.4	2.1	8.0	12.0	Q1
TP2262-VR	8-Pin MSOP	330.0	17.6	5.2	3.3	1.5	8.0	12.0	Q1
TP2262-TSR	8-Pin TSSOP	330.0	17.6	6.8	3.3	1.2	8.0	12.0	Q1
TP2262-FR	8-Pin DFN2*2	180.0	13.1	2.3	2.3	1.1	4.0	8.0	Q1
TP2262-F2R	8-Pin DFN3*3	330.0	17.6	3.35	3.35	1.13	8.0	12.0	Q1
TP2264-SR	14-Pin SOIC	330.0	21.6	6.5	9.0	2.1	8.0	16.0	Q1
TP2264-TR	14-Pin TSSOP	330.0	17.6	6.8	5.4	1.2	8.0	12.0	Q1

Package Outline Dimensions

SOT23-5

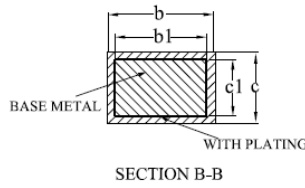
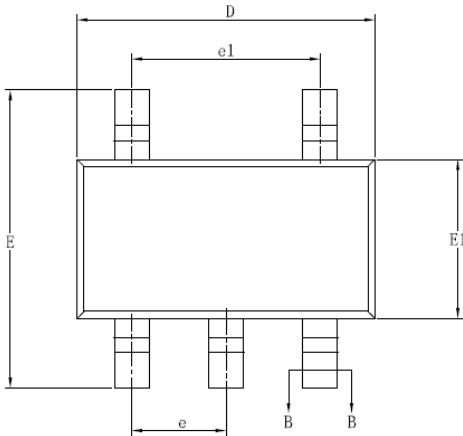
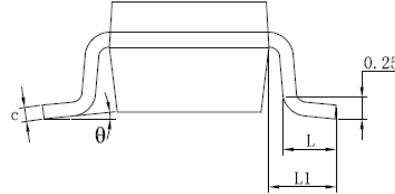
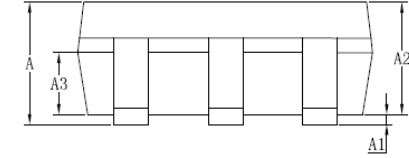

SYMBOL	MILLIMETER		
	MIN	NOM	MAX
A	—	—	1.25
A1	0.04	—	0.10
A2	1.00	1.10	1.20
A3	0.60	0.65	0.70
b	0.33	—	0.41
b1	0.32	0.35	0.38
c	0.15	—	0.19
c1	0.14	0.15	0.16
D	2.82	2.92	3.02
E	2.60	2.80	3.00
E1	1.50	1.60	1.70
e	0.95BSC		
e1	1.90BSC		
L	0.30	—	0.60
L1	0.60REF		
θ	0	—	8°

SOIC-8

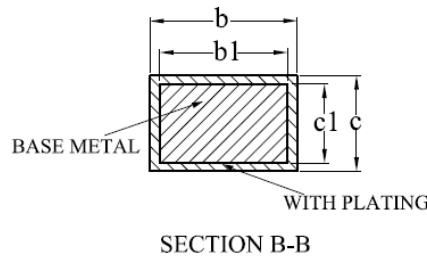
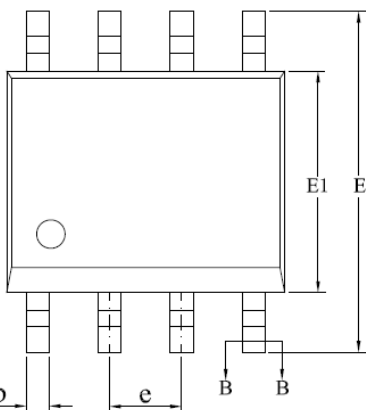
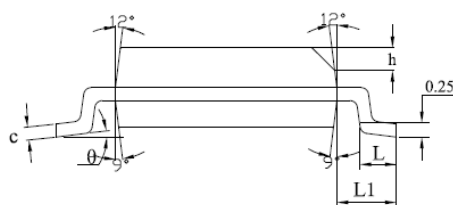
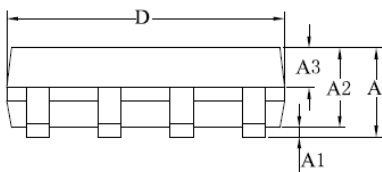

SYMBOL	MILLIMETER		
	MIN	NOM	MAX
A	—	—	1.75
A1	0.10	—	0.225
A2	1.30	1.40	1.50
A3	0.60	0.65	0.70
b	0.39	—	0.47
b1	0.38	0.41	0.44
c	0.20	—	0.24
c1	0.19	0.20	0.21
D	4.80	4.90	5.00
E	5.80	6.00	6.20
E1	3.80	3.90	4.00
e	1.27BSC		
h	0.25	—	0.50
L	0.50	—	0.80
L1	1.05REF		
θ	0	—	8°

TSSOP-8

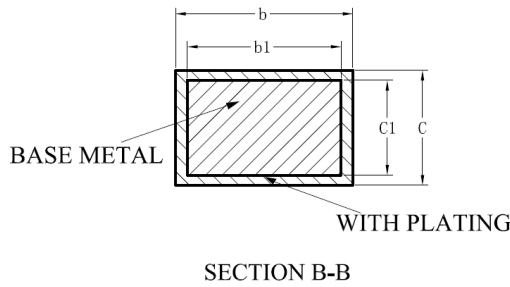
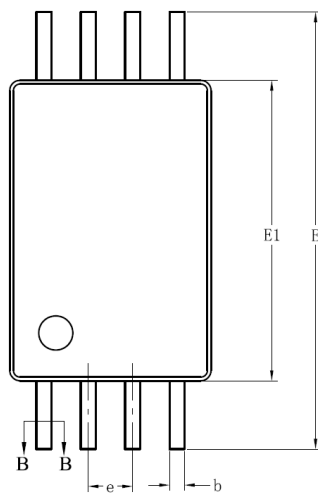
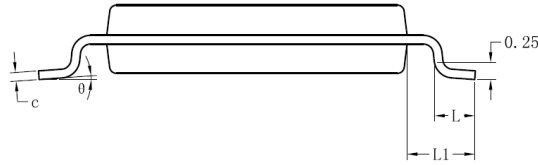
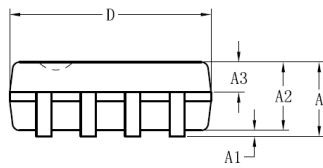

SYMBOL	MILLIMETER		
	MIN	NOM	MAX
A	—	—	1.20
A1	0.05	—	0.15
A2	0.90	1.00	1.05
A3	0.39	0.44	0.49
b	0.20	—	0.28
b1	0.19	0.22	0.25
c	0.13	—	0.17
c1	0.12	0.13	0.14
D	2.90	3.00	3.10
E1	4.30	4.40	4.50
E	6.20	6.40	6.60
e	0.65BSC		
L	0.45	—	0.75
L1	1.00REF		
θ	0	—	8°

MSOP-8

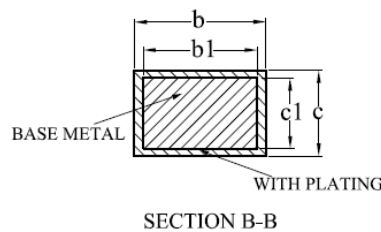
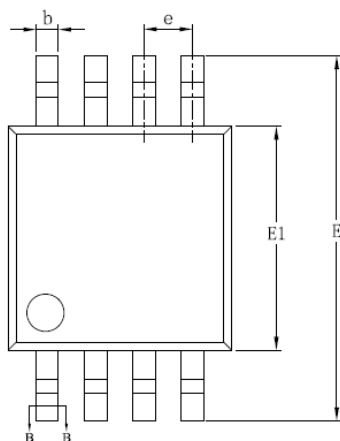
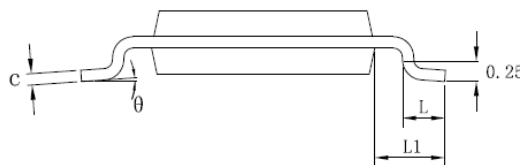
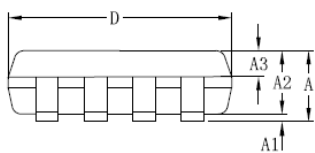

SYMBOL	MILLIMETER		
	MIN	NOM	MAX
A	—	—	1.10
A1	0.05	—	0.15
A2	0.75	0.85	0.95
A3	0.30	0.35	0.40
b	0.28	—	0.36
b1	0.27	0.30	0.33
c	0.15	—	0.19
c1	0.14	0.15	0.16
D	2.90	3.00	3.10
E	4.70	4.90	5.10
E1	2.90	3.00	3.10
e	0.65BSC		
L	0.40	—	0.70
L1	0.95REF		
θ	0	—	8°

DFN8 2*2

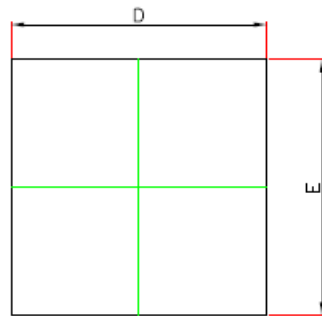

TOP VIEW

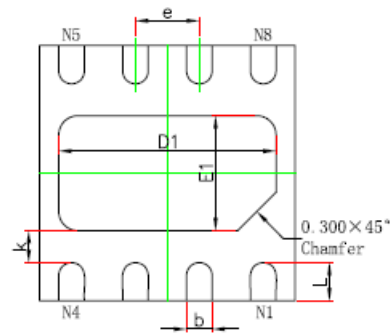

BOTTOM VIEW

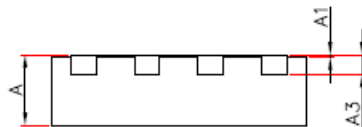

SIDE VIEW

Symbol	Dimensions In Millimeters		Dimensions In Inches	
	Norm.		Norm.	
A	0.550+/-0.050		0.022+/-0.002	
A1	0.000	0.050	0.000	0.002
A3	0.152REF.		0.006REF.	
D	2.000+/-0.100		0.079+/-0.004	
E	2.000+/-0.100		0.079+/-0.004	
D1	1.700+/-0.100		0.067+/-0.004	
E1	0.900+/-0.100		0.035+/-0.004	
k	0.200MIN.		0.008MIN.	
b	0.200+/-0.050		0.008+/-0.002	
e	0.500TYP.		0.020TYP.	
L	0.300+/-0.050		0.012+/-0.002	

DFN8 3*3

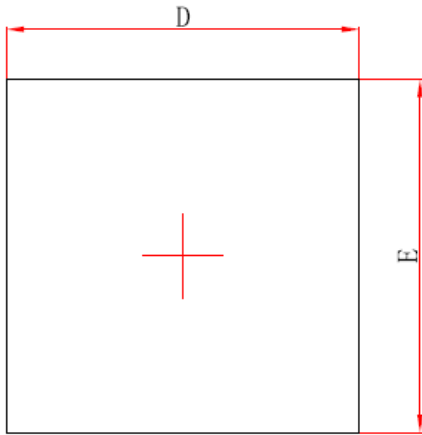

Top View

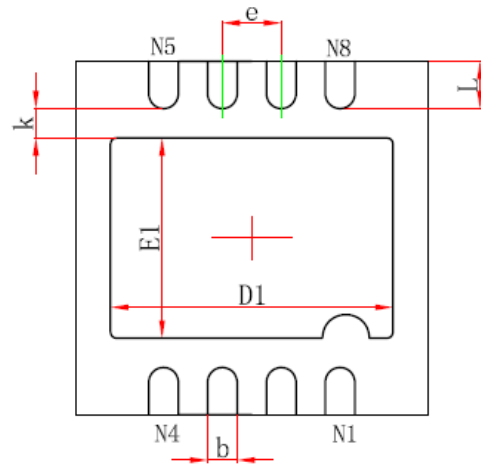

Bottom View

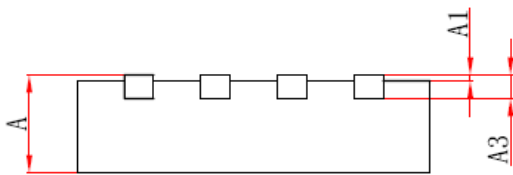

Side View

Symbol	Dimensions In Millimeters		Dimensions In Inches	
	Min.	Max.	Min.	Max.
A	0.700/0.800	0.800/0.900	0.028/0.031	0.031/0.035
A1	0.000	0.050	0.000	0.002
A3	0.203REF.		0.008REF.	
D	2.924	3.076	0.115	0.121
E	2.924	3.076	0.115	0.121
D1	2.300	2.500	0.091	0.098
E1	1.600	1.800	0.063	0.071
k	0.200MIN.		0.008MIN.	
b	0.200	0.300	0.008	0.012
e	0.500TYP.		0.020TYP.	
L	0.324	0.476	0.013	0.019

SOIC-14

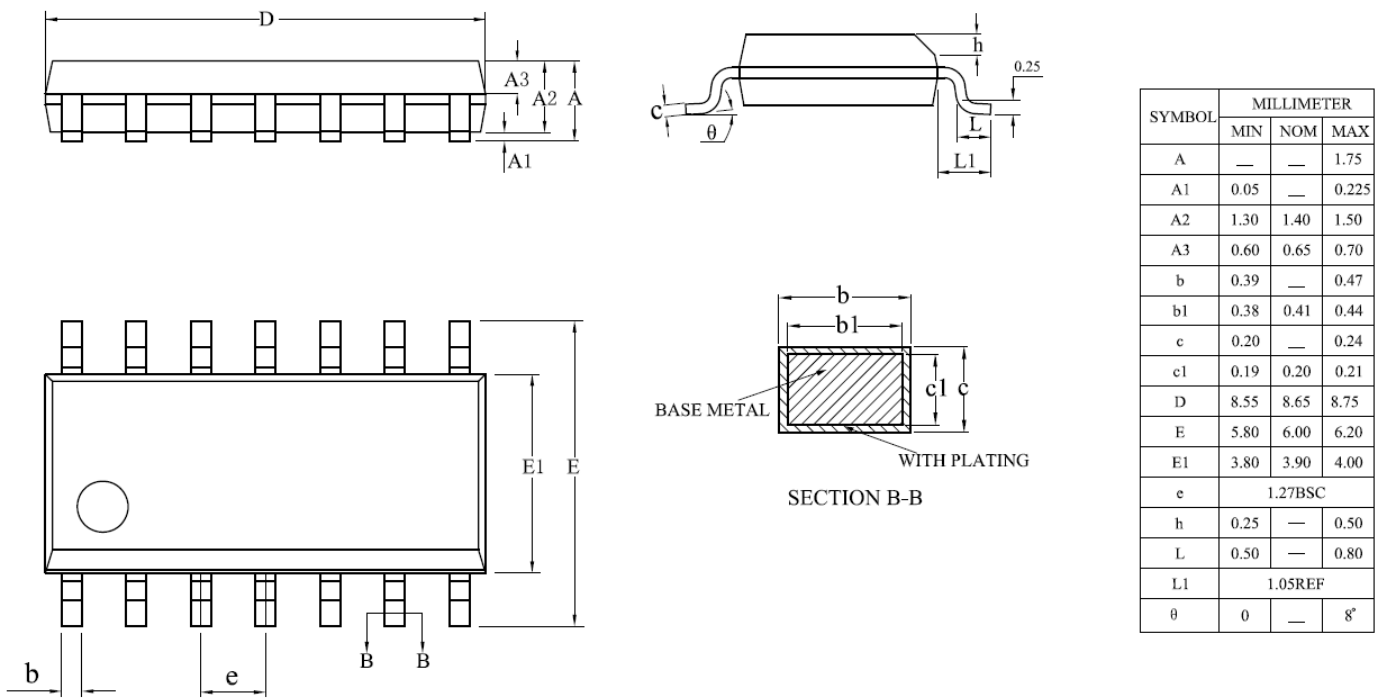

TSSOP-14

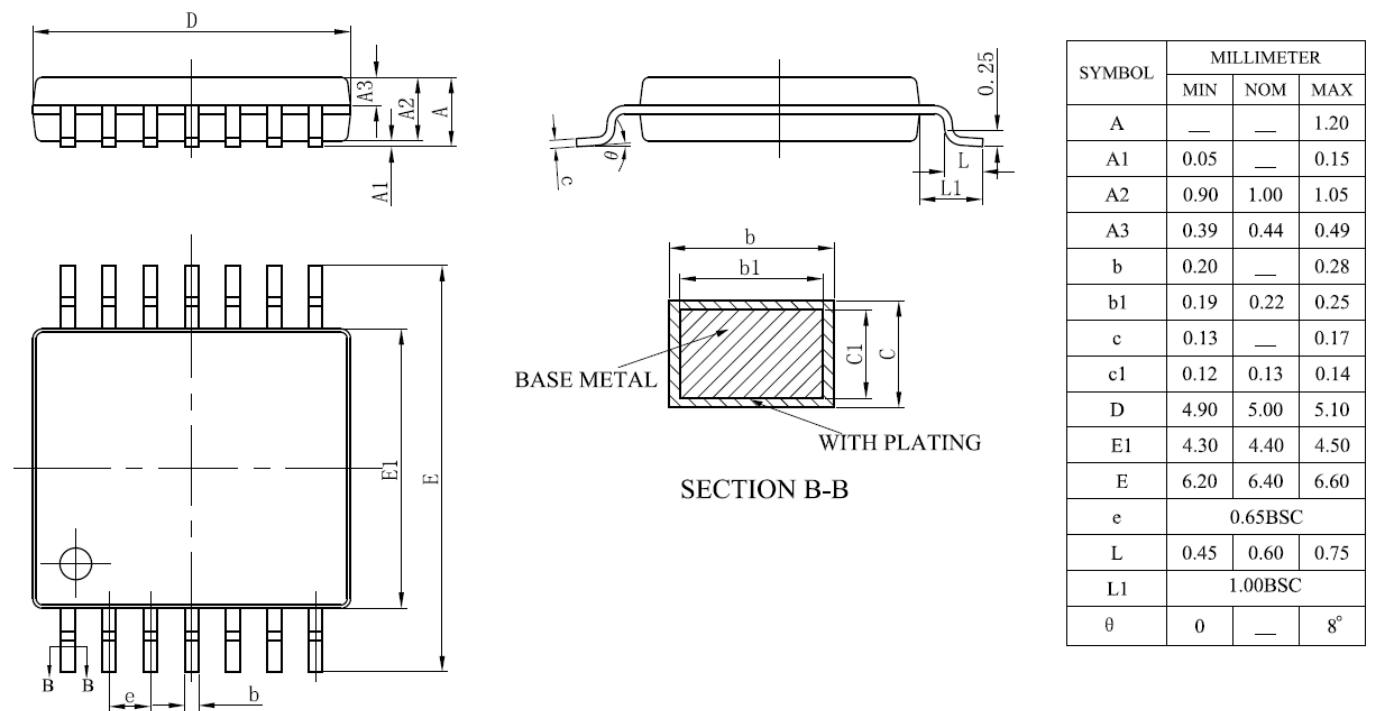

 ***3PEAK and the 3PEAK logo are registered trademarks of 3PEAK INCORPORATED. All other trademarks are the property of their respective owners.***
