

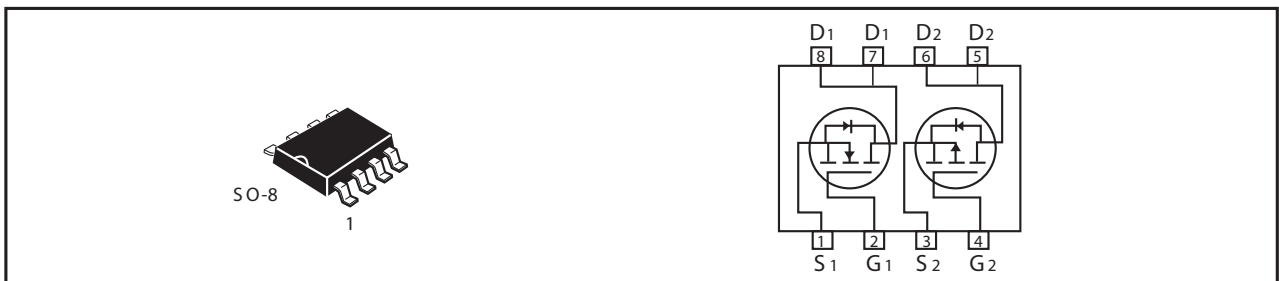

Dual Enhancement Mode Field Effect Transistor (N and P Channel)

PRODUCT SUMMARY (N-Channel)		
V _{DSS}	I _D	R _{DS(ON)} (mΩ) Max
30V	7A	25 @ V _{GS} = 10V
		40 @ V _{GS} = 4.5V

PRODUCT SUMMARY (P-Channel)		
V _{DSS}	I _D	R _{DS(ON)} (mΩ) Max
-30V	-5A	45 @ V _{GS} = -10V
		60 @ V _{GS} = -4.5V



ABSOLUTE MAXIMUM RATINGS (T_A=25°C unless otherwise noted)

Parameter		Symbol	N-Channel	P-Channel	Unit
Drain-Source Voltage		V _{DS}	30	-30	V
Gate-Source Voltage		V _{GS}	±22	±22	V
Drain Current-Continuous ^a @ T _a	25°C	I _D	7	-5	A
	70°C		6	-4.5	A
-Pulsed ^b		I _{DM}	29	-20	A
Drain-Source Diode Forward Current ^a		I _S	1.7	-1.7	A
Maximum Power Dissipation ^a	T _a =25°C	P _D	2		W
	T _a =70°C		1.44		
Operating Junction and Storage Temperature Range		T _J , T _{STG}	-55 to 150		°C

THERMAL CHARACTERISTICS

Thermal Resistance, Junction-to-Ambient ^a	R _{θJA}	62.5	°C/W
--	------------------	------	------

STM8405

N-Channel ELECTRICAL CHARACTERISTICS (T_A = 25 °C unless otherwise noted)

Parameter	Symbol	Condition	Min	Typ ^c	Max	Unit
OFF CHARACTERISTICS						
Drain-Source Breakdown Voltage	BV _{DSS}	V _{GS} = 0V, I _D = 250µA	30			V
Zero Gate Voltage Drain Current	I _{DSS}	V _{DS} = 24V, V _{GS} = 0V			1	µA
Gate-Body Leakage	I _{GSS}	V _{GS} = ±22V, V _{DS} = 0V			±100	nA
ON CHARACTERISTICS ^b						
Gate Threshold Voltage	V _{GS(th)}	V _{DS} = V _{GS} , I _D = 250µA	1	1.5	2	V
Drain-Source On-State Resistance	R _{DS(ON)}	V _{GS} = 10V, I _D = 6.6A		20	25	m ohm
		V _{GS} = 4.5V, I _D = 5A		35	40	m ohm
On-State Drain Current	I _{D(ON)}	V _{DS} = 5V, V _{GS} = 4.5V	20			A
Forward Transconductance	g _{FS}	V _{DS} = 5V, I _D = 6.6A		10		S
DYNAMIC CHARACTERISTICS ^c						
Input Capacitance	C _{ISS}	V _{DS} = 15V, V _{GS} = 0V f = 1.0MHz		765	865	pF
Output Capacitance	C _{OSS}			145	160	pF
Reverse Transfer Capacitance	C _{RSS}			96	113	pF
Gate resistance	R _g	V _{GS} = 0V, V _{DS} = 0V, f = 1.0MHz		3		ohm
SWITCHING CHARACTERISTICS ^c						
Turn-On Delay Time	t _{D(ON)}	V _{DD} = 15V I _D = 6.6 A V _{GS} = 10V R _{GEN} = 3 ohm		7.4	8.5	ns
Rise Time	t _r			27.7	32	ns
Turn-Off Delay Time	t _{D(OFF)}			12.2	14	ns
Fall Time	t _f			7.6	9	ns
Total Gate Charge	Q _g	V _{DS} = 15V, I _D = 6.6A, V _{GS} = 10V		14.1	16	nC
		V _{DS} = 15V, I _D = 6.6A, V _{GS} = 4.5V		6.2	7	nC
Gate-Source Charge	Q _{gs}	V _{DS} = 15V, I _D = 6.6 A		2.2	2.6	nC
Gate-Drain Charge	Q _{gd}	V _{GS} = 10V		4.1	4.8	nC

STM8405

P-Channel ELECTRICAL CHARACTERISTICS (T_A = 25 °C unless otherwise noted)

Parameter	Symbol	Condition	Min	Typ ^c	Max	Unit
OFF CHARACTERISTICS						
Drain-Source Breakdown Voltage	BV _{DSS}	V _{GS} = 0V, I _D = -250uA	-30			V
Zero Gate Voltage Drain Current	I _{DSS}	V _{DS} = -24V, V _{GS} = 0V			-1	uA
Gate-Body Leakage	I _{GSS}	V _{GS} = ±22V, V _{DS} = 0V			±100	nA
ON CHARACTERISTICS ^b						
Gate Threshold Voltage	V _{GS(th)}	V _{DS} = V _{GS} , I _D = -250uA	-1	-1.5	-2.5	V
Drain-Source On-State Resistance	R _{DS(ON)}	V _{GS} = -10V, I _D = -5A		35	45	m ohm
		V _{GS} = -4.5V, I _D = -4A		50	60	m ohm
On-State Drain Current	I _{D(ON)}	V _{DS} = -5V, V _{GS} = -10V	20			A
Forward Transconductance	g _{FS}	V _{DS} = -5V, I _D = -5A		9		S
DYNAMIC CHARACTERISTICS ^c						
Input Capacitance	C _{ISS}	V _{DS} = -15V, V _{GS} = 0V f = 1.0MHz		721	820	pF
Output Capacitance	C _{OSS}			154	180	pF
Reverse Transfer Capacitance	C _{RSS}			92	108	pF
Gate resistance	R _g	V _{GS} = 0V, V _{DS} = 0V, f = 1.0MHz		3.3		ohm
SWITCHING CHARACTERISTICS ^c						
Turn-On Delay Time	t _{D(ON)}	V _{DD} = -15V R _L = 2.7 ohm V _{GS} = -10V R _{GEN} = 3 ohm		4.7	5.5	ns
Rise Time	t _r			7.8	9	ns
Turn-Off Delay Time	t _{D(OFF)}			47.2	56	ns
Fall Time	t _f			22.6	26	ns
Total Gate Charge	Q _g	V _{DS} = -15V, I _D = -5A, V _{GS} = -10V		13.8	16	nC
		V _{DS} = -15V, I _D = -5A, V _{GS} = -4.5V		7.3	8.6	nC
Gate-Source Charge	Q _{gs}	V _{DS} = -15V, I _D = -5 A		1.5	2	nC
Gate-Drain Charge	Q _{gd}	V _{GS} = -10V		4.3	5	nC

STM8405

ELECTRICAL CHARACTERISTICS ($T_A=25^{\circ}\text{C}$ unless otherwise noted)

Parameter	Symbol	Condition	Min	Typ ^c	Max	Unit
DRAIN-SOURCE DIODE CHARACTERISTICS^b						
Diode Forward Voltage	V_{SD}	$V_{GS} = 0\text{V}, I_S = 1.7\text{A}$	N-Ch	0.8	1.2	V
		$V_{GS} = 0\text{V}, I_S = -1.7\text{A}$	P-Ch	-0.78	-1.2	

Notes

- a. Surface Mounted on FR4 Board, $t \leq 10\text{sec}$.
 - b. Pulse Test: Pulse Width $\leq 300 \mu\text{s}$, Duty Cycle $\leq 2\%$.
 - c. Guaranteed by design, not subject to production testing.
- N-Channel

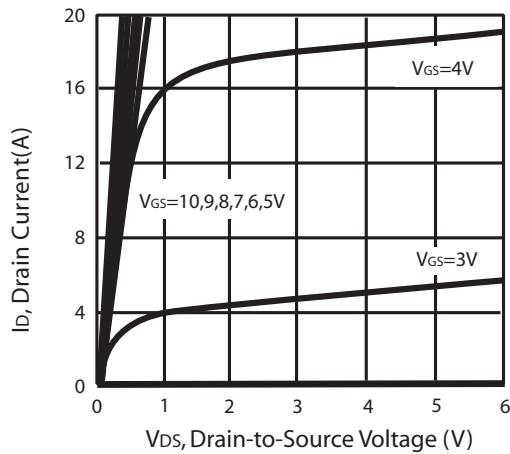

Figure 1. Output Characteristics

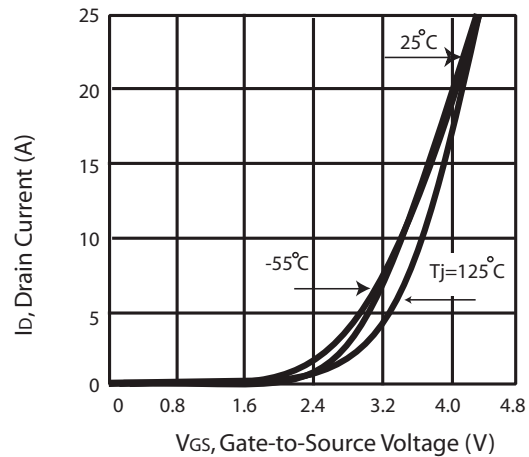

Figure 2. Transfer Characteristics

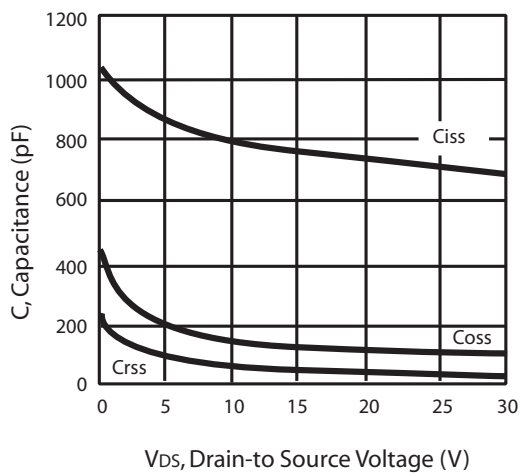

Figure 3. Capacitance

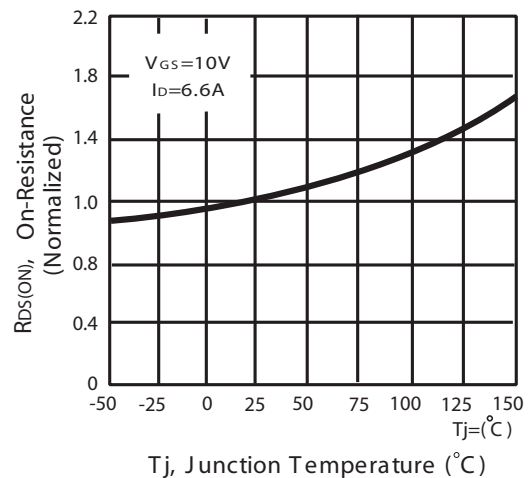

Figure 4. On-Resistance Variation with Drain Current and Temperature

STM8405

N-Channel

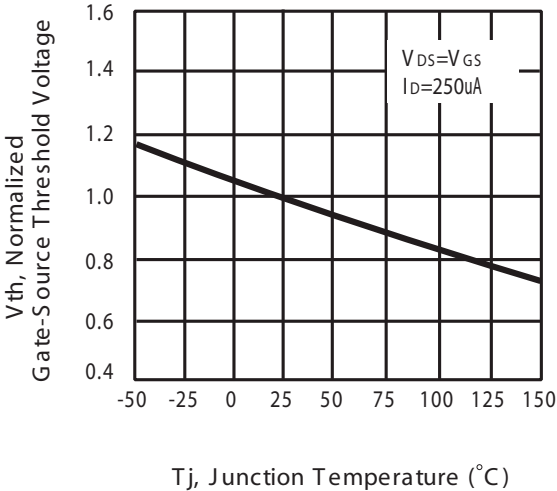

Figure 5. Gate Threshold Variation with Temperature

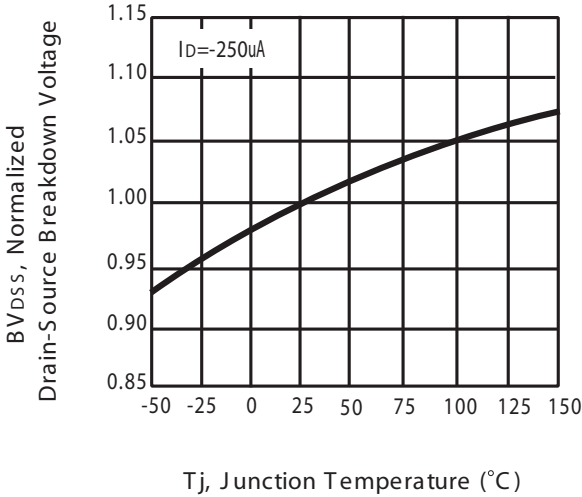

Figure 6. Breakdown Voltage Variation with Temperature

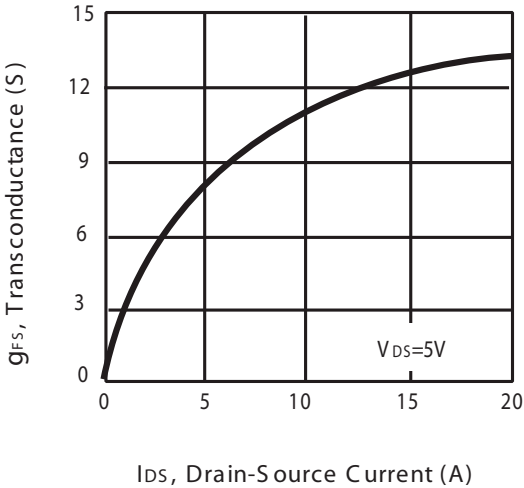

Figure 7. Transconductance Variation with Drain Current

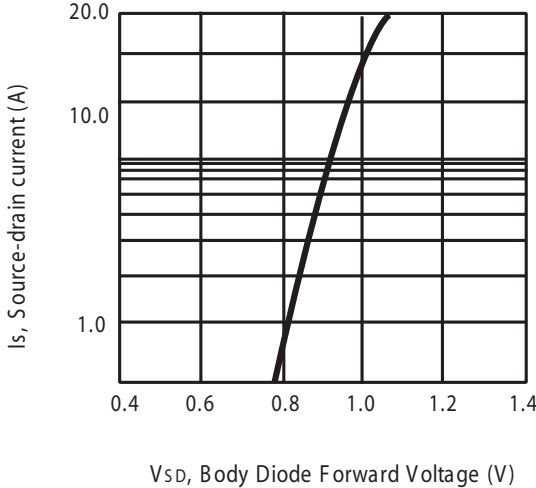

Figure 8. Body Diode Forward Voltage Variation with Source Current

STM8405

P-Channel

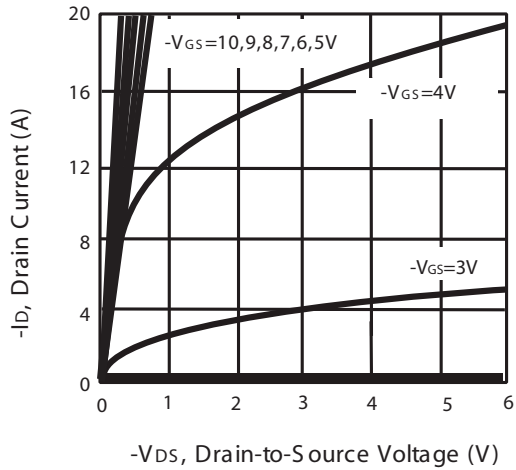

Figure 1. Output Characteristics

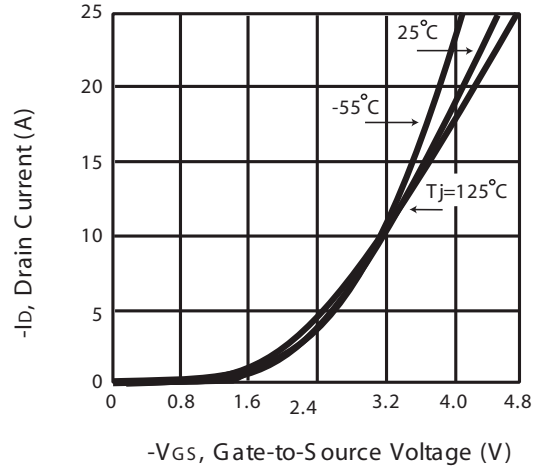

Figure 2. Transfer Characteristics

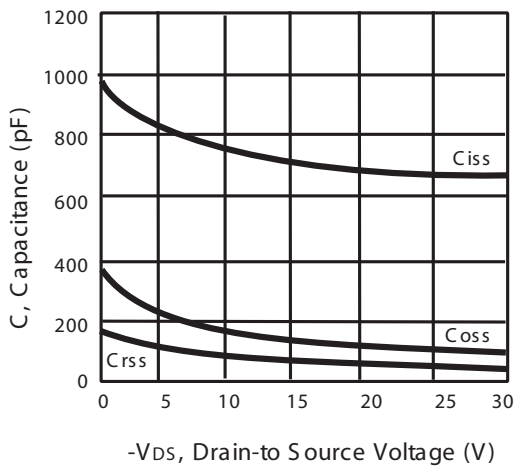

Figure 3. Capacitance

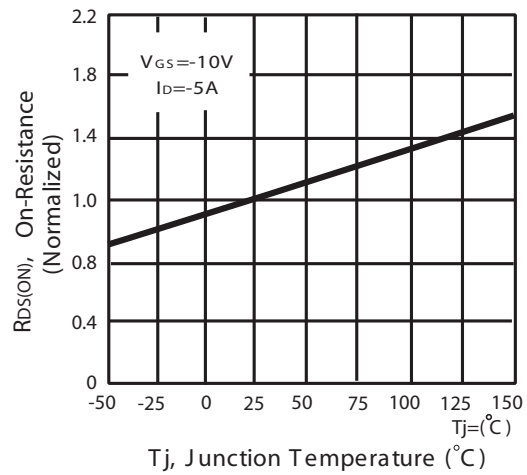

Figure 4. On-Resistance Variation with Temperature

STM8405

P-Channel

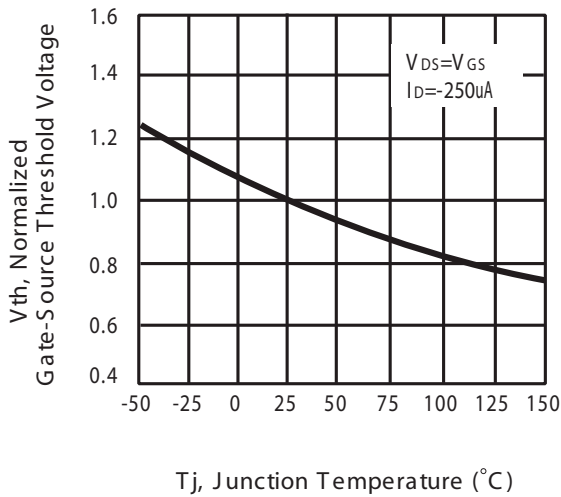

Figure 5. Gate Threshold Variation with Temperature

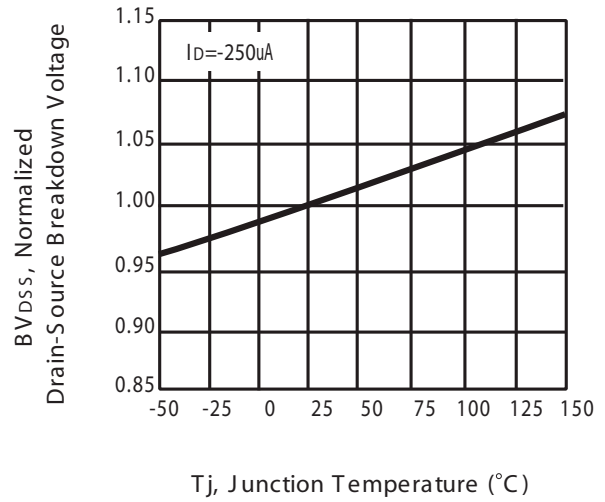

Figure 6. Breakdown Voltage Variation with Temperature

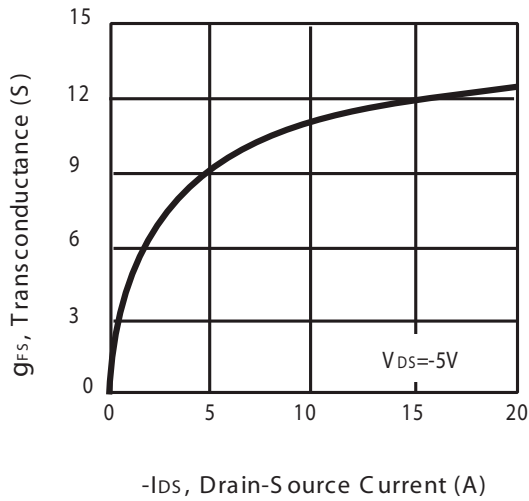

Figure 7. Transconductance Variation with Drain Current

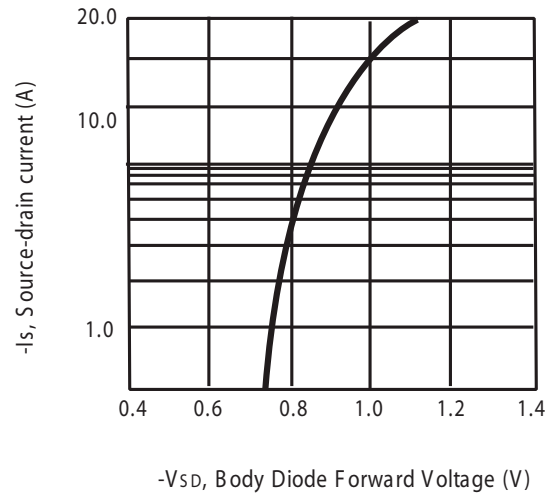
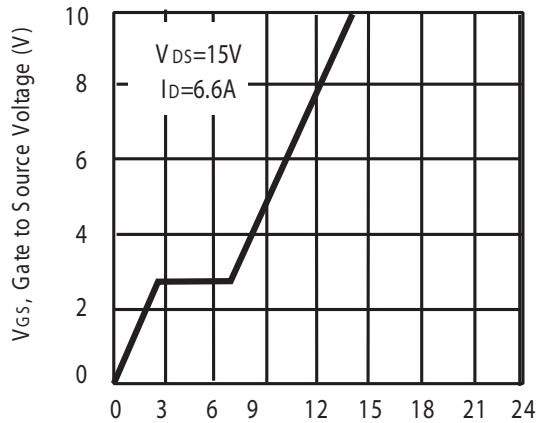

Figure 8. Body Diode Forward Voltage Variation with Source Current

STM8405

N-Channel



Qg, Total Gate Charge (nC)
Figure 9. Gate Charge

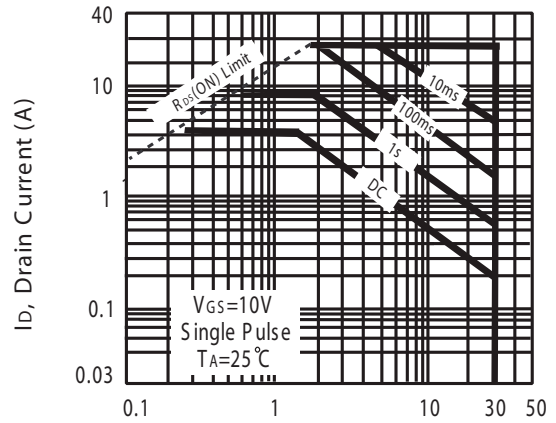

VDs, Drain-Source Voltage (V)
Figure 10. Maximum Safe Operating Area

P-Channel

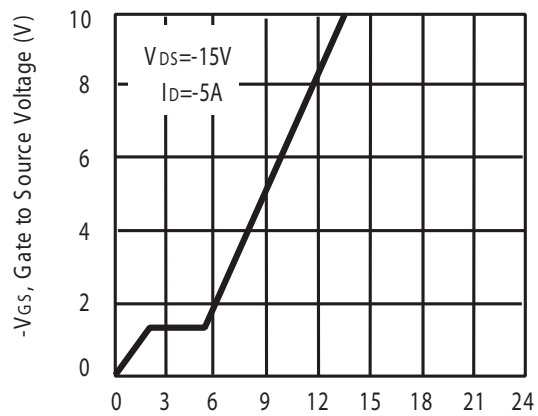

Qg, Total Gate Charge (nC)
Figure 9. Gate Charge

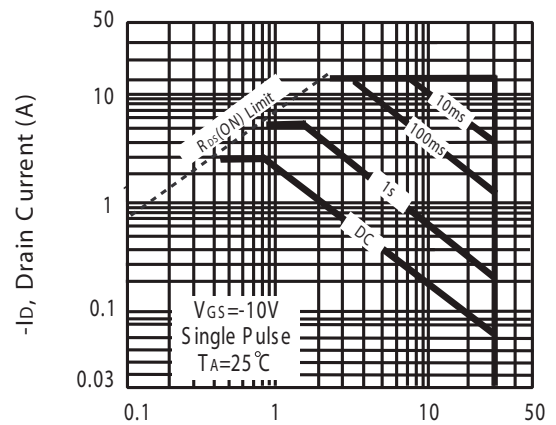

-VDs, Body Diode Forward Voltage (V)
Figure 10. Maximum Safe Operating Area

STM8405

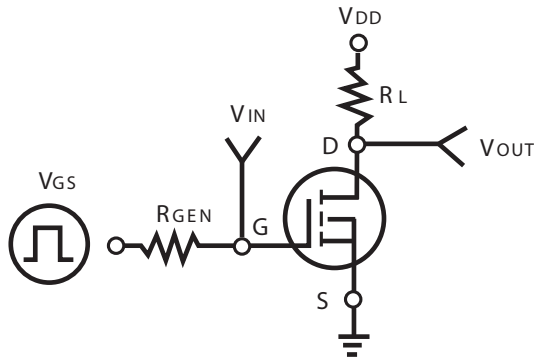

Figure 11. Switching Test Circuit

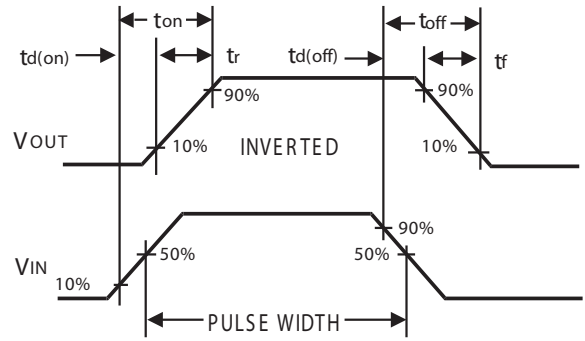
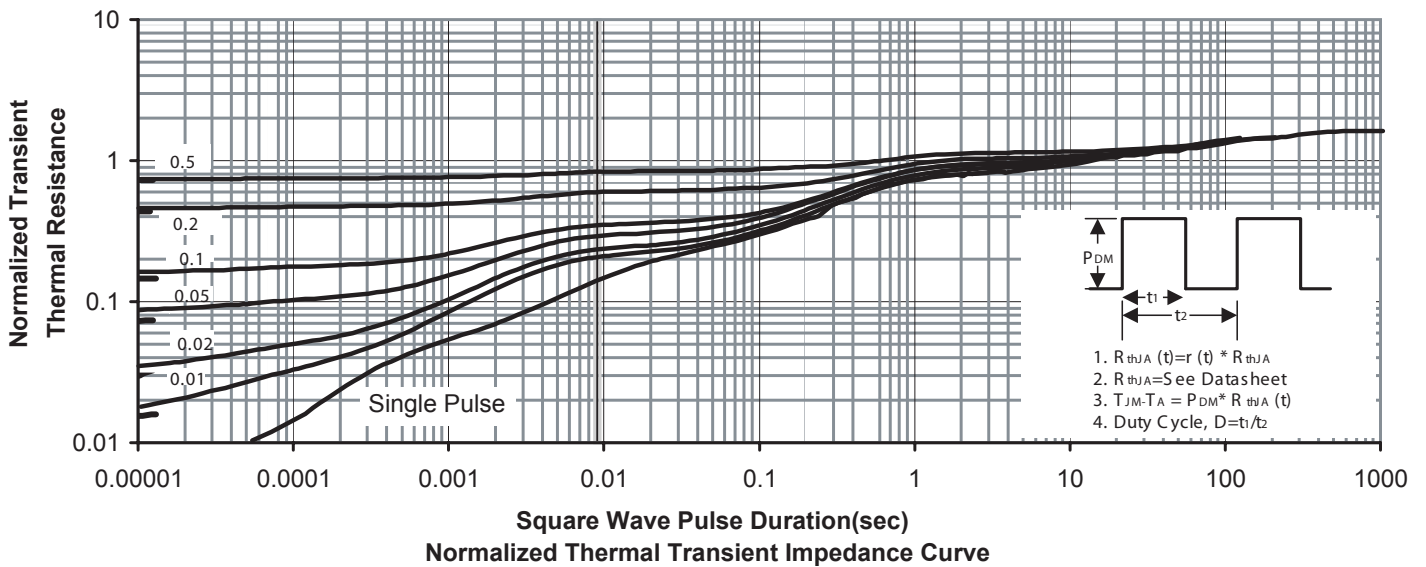
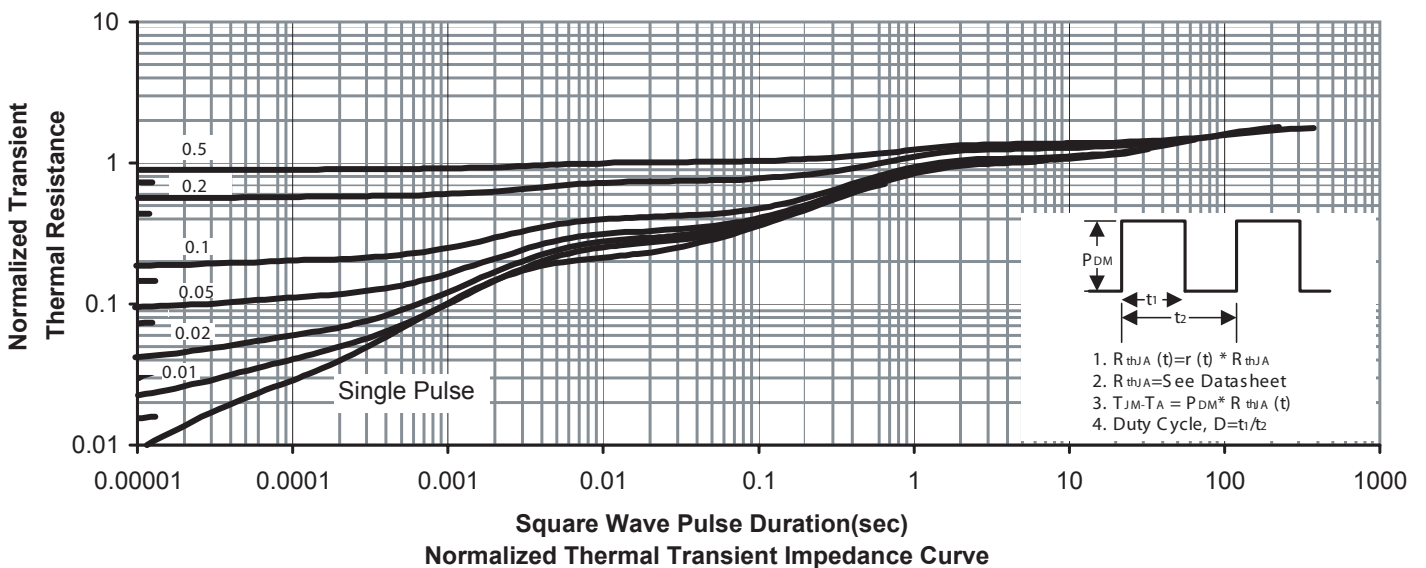

Figure 12. Switching Waveforms

N-Channel



P-Channel



STM8405

PACKAGE OUTLINE DIMENSIONS

SO-8

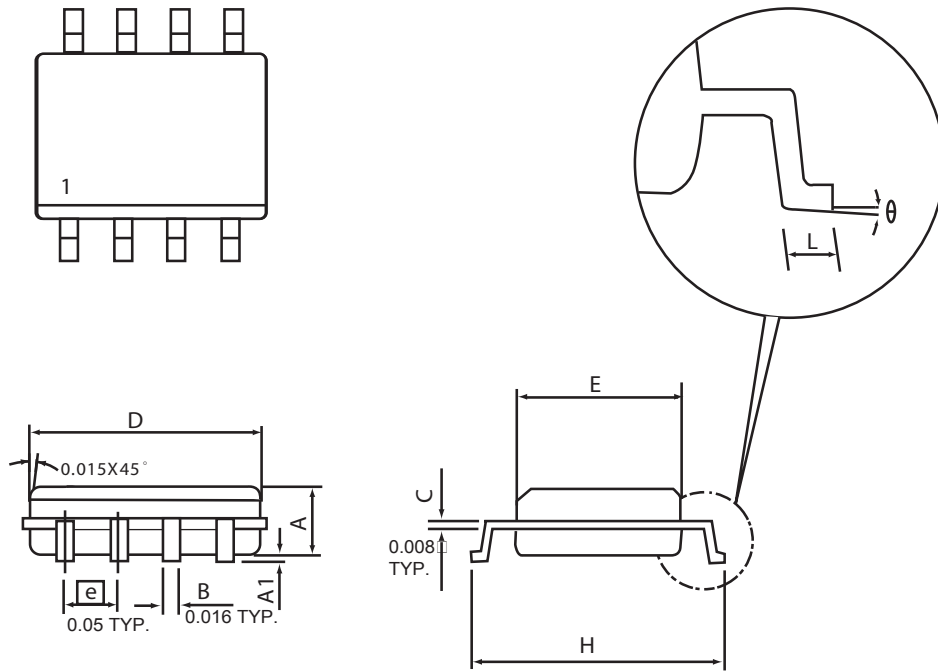

SYMBOLS	MILLIMETERS		INCHES	
	MIN	MAX	MIN	MAX
A	1.35	1.75	0.053	0.069
A1	0.10	0.25	0.004	0.010
D	4.80	4.98	0.189	0.196
E	3.81	3.99	0.150	0.157
H	5.79	6.20	0.228	0.244
L	0.41	1.27	0.016	0.050
θ	0°	8°	0°	8°

STM8405

SO-8 Tape and Reel Data

SO-8 Carrier Tape

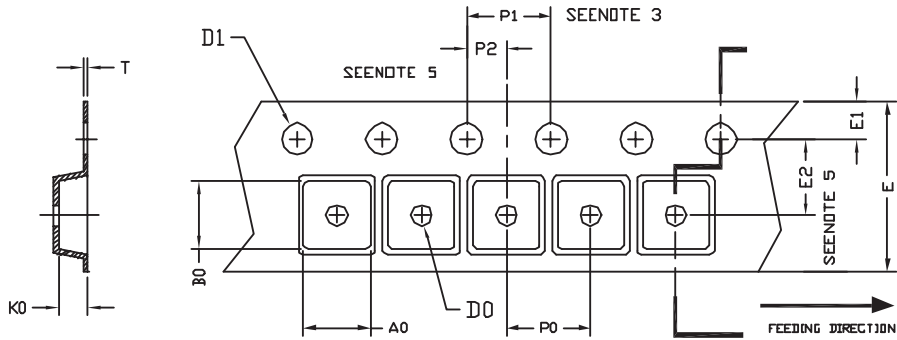

unit:mm

PACKAGE	A0	B0	K0	D0	D1	E	E1	E2	P0	P1	P2	T
SOP 8N 150mil	6.40	5.20	2.10	$\phi 1.5$ (MIN)	$\phi 1.5 \square$ $+ 0.1 \square$ $- 0.0$	12.0 ± 0.3	1.75	$5.5 \square$ ± 0.05	8.0	4.0	$2.0 \square$ ± 0.05	$0.3 \square$ ± 0.05

SO-8 Reel

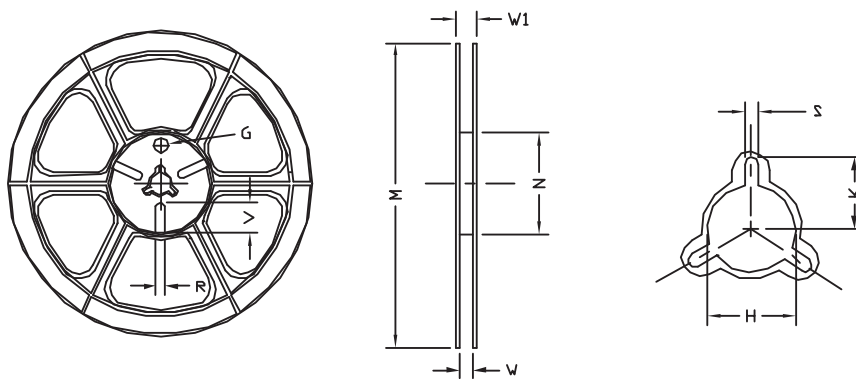

UNIT:mm

TAPE SIZE	REEL SIZE	M	N	W	W1	H	K	S	G	R	V
12 mm	$\phi 330$	330 ± 1	62 ± 1.5	12.4 $+ 0.2$	16.8 $- 0.4$	$\phi 12.75$ $+ 0.15$	---	2.0 ± 0.15	---	---	---