

The information provided herein is from CONNELY Electronic Co., Ltd. and is confidential. Any disclosure to a party other than the recipient is prohibited. The intellectual properties and its rights contained herein, including but not limited to, trademarks, patents, copyrights, trade secrets, and technical know-how, are owned exclusively by CONNELY or its affiliates. Unauthorized use of this information in any format or manner, CONNELY may enforce its intellectual property rights at its own discretion; failures or delays to exercise such rights does not constitute a waiver of such rights.

1 2 3 4 5 6 7 8

REV.	DESCRIPTION	DRAWN	CHECKED	APPROVED
A	NEW RELEASE	LJH 09/26/05'		LJC 09/26/05'
B	整理图面	YCH 05/26/07'		LJC 05/26/07'
C	增加锁螺丝类型	YCH 06/30/07'		LJC 06/30/07'
D	DRAWING UPDATE	JLZ 08/08/18'		

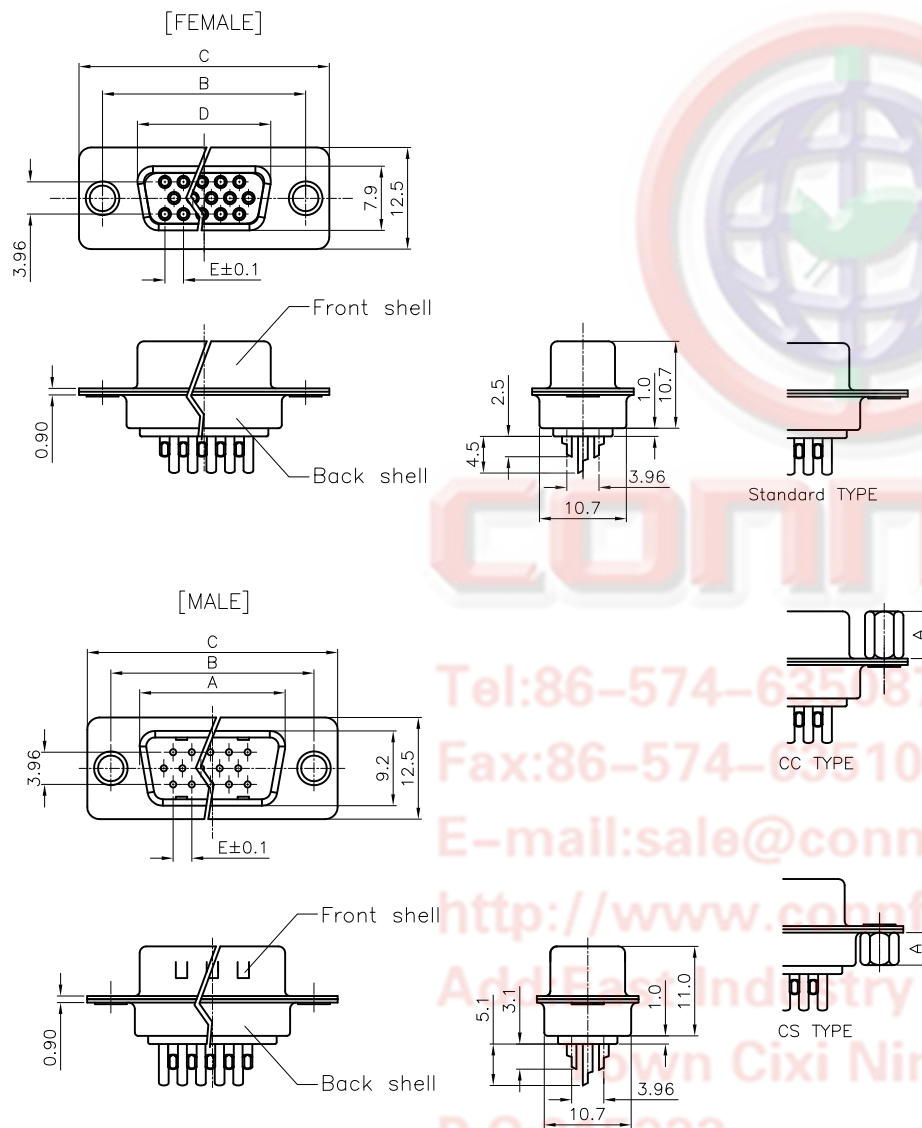

- NOTES:
- ELECTRICAL CHARACTERISTICS:
    - CONTACT RESISTANCE: 20mΩ Max. INITIAL.
    - DIELECTRIC WITHSTANDING VOLTAGE: 500V AC(rms) FOR 1 MINUTE.
    - INSULATION RESISTANCE: 1000MΩ Min.
  - ENVIRONMENT CHARACTERISTICS:
    - TEMPERATURE RANGE: -40°C~+105°C.
  - MATERIALS
    - INSULATOR: THERMOPLASTIC.
    - CONTACT: COPPER ALLOY.
    - SHELL: STEEL.
    - SCREW: COPPER ALLOY.
  - PRODUCT NUMBER CODE:
 

DS1035- X X X X X X X X

- SCREW DIM. A  
 S: Standard(W/O nut)  
 1: 3.00  
 2: 4.00  
 3: 4.50  
 4: 5.00  
 5: 5.50  
 6: 5.80
- SCREW TYPE  
 S: Standard(W/O nut)  
 1: CC TYPE  
 2: CS TYPE
- CONTACT PLATING  
 8: FULL GOLD FLASH  
 Si: SELECTIVE GOLD FLASH
- SHELL PLATING  
 T: FORNT & BACK SHELL TIN  
 N: FORNT SHELL NICKEL, BACK SHELL TIN
- HOUSING COLOR  
 B: BLACK  
 W: WHITE  
 U: BLUE
- CONNECTOR TYPE  
 M: MALE  
 F: FEMALE
- No.OF CONTACTS  
 15: 15pos. 26: 26pos.  
 44: 44pos. 62: 62pos.

Dimension

Position	A±0.2	B±0.2	C±0.3	D	E
15	17.90	24.99	30.80	16.33	2.29
26	26.50	33.32	39.14	24.66	2.29
44	40.00	47.04	53.04	38.38	2.29
62	56.50	63.50	69.32	54.84	2.14
78	54.30	61.00	67.04	52.34	2.14

GENERAL TOLERANCE		ANGLE TOLERANCE	
X.	±0.60	X.	±5°
.X	±0.38	.X	±3°
.XX	±0.25	.XX	±2°

PROJECTION	TITLE	D-SUB H.D SOLDER TYPE	
UNITS	mm		
SHEET SIZE	A4	SERIES	DS1035 SERIES

DRAWING TYPE	CUSTOMER		
SCALE	1:1	SHEET	1 OF 1
DRAWING NO.	C-DS1035-XXXXXXX-D		

**晨翔电子有限公司**  
**CONNFLY CONNELY ELECTRONIC CO. LTD**

Tel:86-574-62518787  
 Fax:86-574-62510817  
 E-mail:sale@connfly.com  
 http://www.connfly.com  
 Add: East Industry Zone KuangYan  
 Town Cixi Ningbo China  
 P.C:315333

1 2 3 4 5 6 7 8

Dept  
Qty  
DC 1  
ED 1  
IE 1  
ISO 1  
PD 1  
R&D 1  
SD 1  
QA 1  
QC 1  
QE 1

The information provided herein is from CONNELY Electronic Co., Ltd. and is confidential. Any disclosure to a party other than the recipient is prohibited. The intellectual properties and its rights contained herein, including but not limited to, trademarks, patents, copyrights, trade secrets, and technical know-how, are owned exclusively by CONNELY or its affiliates. Unauthorized use or reproduction of this document in any format or manner, CONNELY may enforce its intellectual property rights at its own discretion; failures or delays to exercise such rights does not constitute a waiver of such rights.

REV.	DESCRIPTION	DRAWN	CHECKED	APPROVED
A	NEW RELEASE	LL 12/06/06'	~	LJC 12/06/06'
B	增加锁螺丝类型	YCH 06/30/07'	~	LJC 06/30/07'
C	DRAWING UPDATE	JLZ 07/20/17'	HZW 07/20/17'	LJC 07/20/17'
D	DRAWING UPDATE	JLZ 08/08/18'	~	

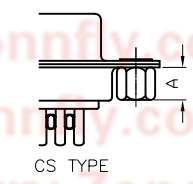
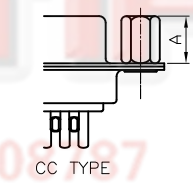
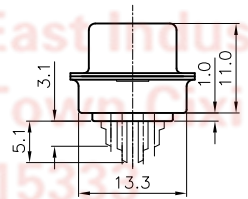
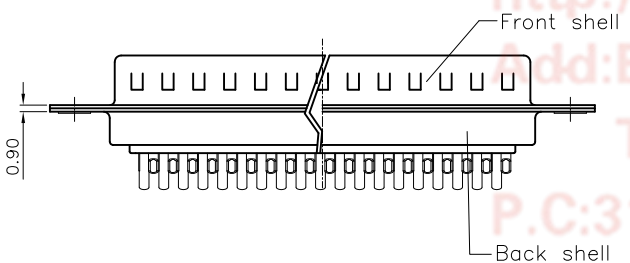
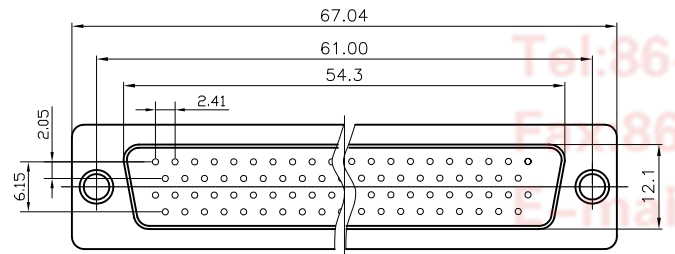
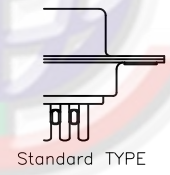
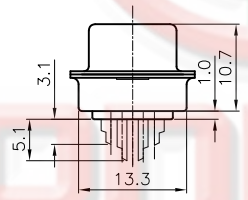
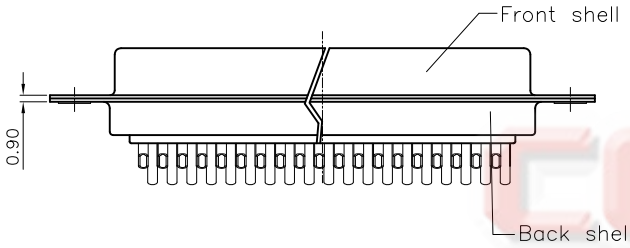
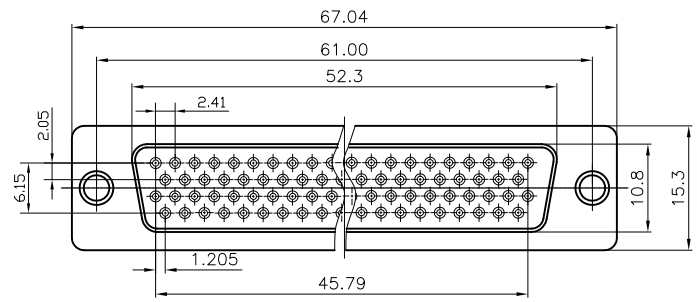

NOTES:

- ELECTRICAL CHARACTERISTICS:
  - CONTACT RESISTANCE: 20mΩ Max. INITIAL.
  - DIELECTRIC WITHSTANDING VOLTAGE: 500V AC(rms) FOR 1 MINUTE.
  - INSULATION RESISTANCE: 1000MΩ Min.
- ENVIRONMENT CHARACTERISTICS:
 

TEMPERATURE RANGE: -40°C~+105°C.
- MATERIALS
  - INSULATOR: THERMOPLASTIC.
  - CONTACT: COPPER ALLOY.
  - SHELL: STEEL.
  - SCREW: COPPER ALLOY.
- PRODUCT NUMBER CODE:
 

DS1035- X X X X X X X X

  - SCREW DIM. A
    - S: Standard(W/O nut)
    - 1: 3.00
    - 2: 4.00
    - 3: 4.50
    - 4: 5.00
    - 5: 5.50
    - 6: 5.80
  - SCREW TYPE
    - S: Standard(W/O nut)
    - 1: CC TYPE
    - 2: CS TYPE
  - CONTACT PLATING
    - 8: FULL GOLD FLASH
    - Si: SELECTIVE GOLD FLASH
  - SHELL PLATING
    - T: FORNT & BACK SHELL TIN
    - N: FORNT SHELL NICKEL, BACK SHELL TIN
  - HOUSING COLOR
    - B: BLACK
    - W: WHITE
    - U: BLUE
  - CONNECTOR TYPE
    - M: MALE
    - F: FEMALE
  - No.OF CONTACTS
    - 78: 78pos.

GENERAL TOLERANCE		ANGLE TOLERANCE	
X.	±0.60	X.	±5°
.X	±0.38	.X	±3°
.XX	±0.25	.XX	±2°
DRAWING TYPE		CUSTOMER	
SCALE		1:1	SHEET 1 OF 1
DRAWING NO.		C-DS1035-78XXXXXX-D	

PROJECTION	TITLE
UNITS	D-SUB H.D SOLDER TYPE
SHEET SIZE	SERIES DS1035 SERIES

**晨翔电子有限公司**  
**CONNFLY CONNELY ELECTRONIC CO. LTD**