

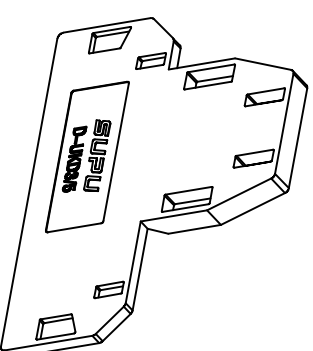

宁波速普电子有限公司
NINGBO SUPU ELECTRONICS.CO.,LTD

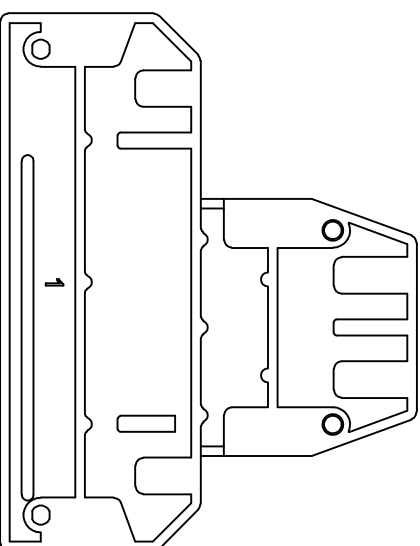
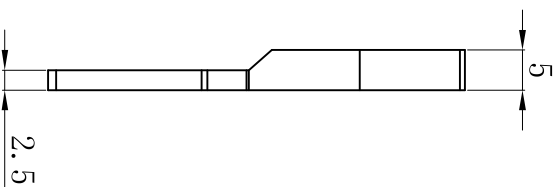
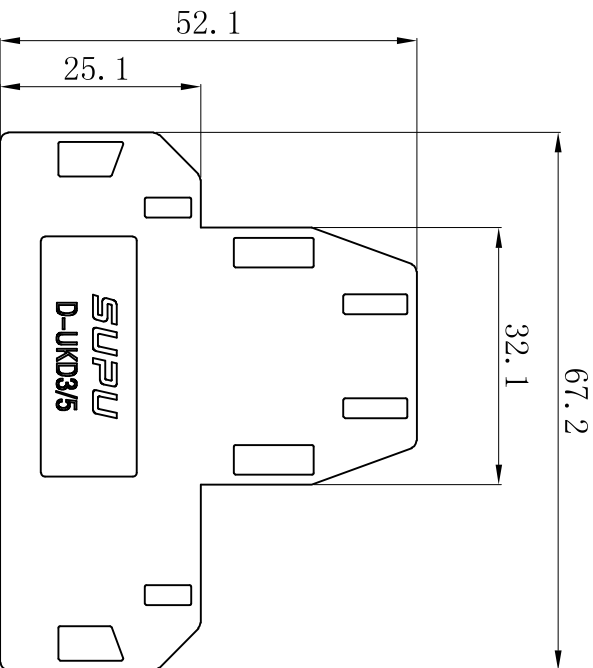

技术参数/Technical Parameter	
材料/Insulating material	PA66
阻燃等级/Flammability rating	UL94 V-0

订货信息
Order Info

订货号	颜色
303121	灰色



宁波速普电子有限公司
NINGBO SUPU ELECTRONICS.CO.,LTD

DWG.	Zhang	2015. 5. 15		Rev	A	303121 端板规格书	
CHK.				Dimension	Sheet		1 of 1
APP.				mm [inch]			