

Click to
ORDER
samples

AM1PR-NZ



The AM1PR-NZ is a DC/DC converter that offers a regulated output which contributes to more stable and reliable output performance. Offering a common DIP8 package and a SMD option for satisfying the requirement of compact size. Featuring a 2:1 input voltage range of 9-18VDC/18-36VDC and 1500VDC isolation, this series will offer many benefits to your new system design.

This new series offers great operating temperatures, from -40°C to 85°C with no derating. Furthermore, a high MTBF of 1,000,000h, continuous output short circuit protection (OSCP), under voltage lock-out come standard with the series.

The AM1PR-NZ is perfect for grid power, LED, instrumentation, industrial controls, communication, and civil applications.

Features



- Operating Temp: -40 °C to +85 °C
- Isolation voltage: 1500VDC
- High efficiency: Up to 80% typ.
- Regulated single and dual output
- Continuous output short circuit protection
- Compact DIP and SMD package
- Design to meet EN62368



Summary

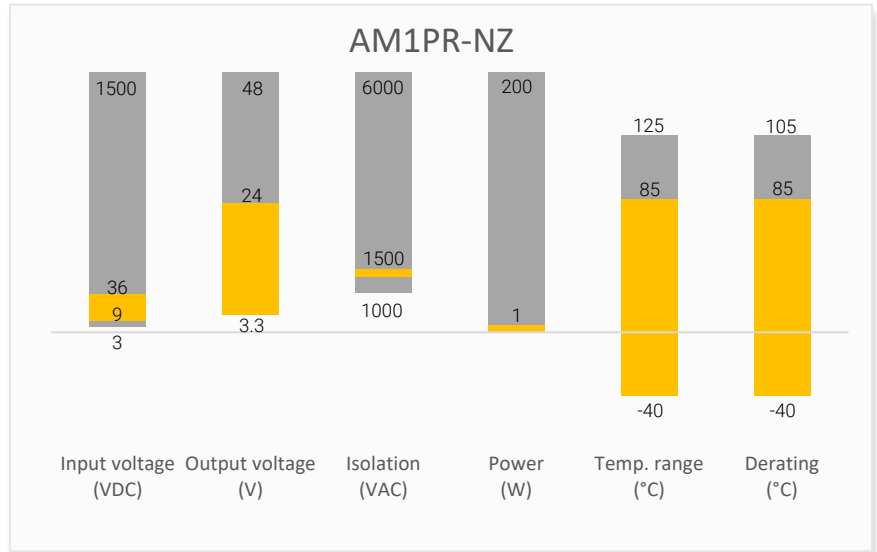

Training

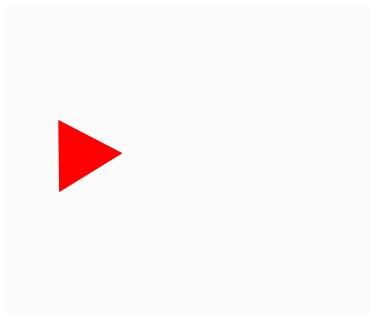

Product Training Video
(click to open)

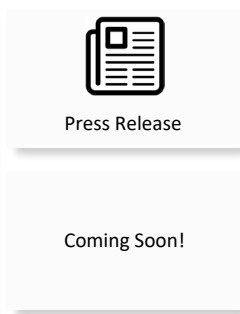

Application Notes

Applications



Power Grid



Industrial



Telecom



Instrumentation

Models & Specifications

Single Output							
Model	Input Voltage (VDC)	Output Voltage (VDC)	Nominal Vin Input Current Max (mA)		Output Current Max (mA)	Maximum Capacitive Load (μF)	Efficiency Full Load Typ (%)
			No Load	Full Load			
AM1PR-1203SNZ	12 (9-18)	3.3	30	114	303	2700	75
AM1PR-1205SNZ	12 (9-18)	5	30	114	200	2200	77
AM1PR-1212SNZ	12 (9-18)	12	30	114	83	1000	79
AM1PR-1215SNZ	12 (9-18)	15	30	114	67	680	80
AM1PR-1224SNZ	12 (9-18)	24	30	114	42	470	76
AM1PR-2403SNZ	24 (18-36)	3.3	10	57	303	2700	75
AM1PR-2405SNZ	24 (18-36)	5	10	57	200	2200	77
AM1PR-2412SNZ	24 (18-36)	12	10	57	83	1000	78
AM1PR-2415SNZ	24 (18-36)	15	10	57	67	680	78
AM1PR-2424SNZ	24 (18-36)	24	10	57	42	470	77
AM1PRL-1203SNZ	12 (9-18)	3.3	30	114	303	2700	75
AM1PRL-1205SNZ	12 (9-18)	5	30	114	200	2200	77
AM1PRL-1212SNZ	12 (9-18)	12	30	114	83	1000	79
AM1PRL-1215SNZ	12 (9-18)	15	30	114	67	680	80
AM1PRL-1224SNZ	12 (9-18)	24	30	114	42	470	76
AM1PRL-2403SNZ	24 (18-36)	3.3	10	57	303	2700	75
AM1PRL-2405SNZ	24 (18-36)	5	10	57	200	2200	77
AM1PRL-2412SNZ	24 (18-36)	12	10	57	83	1000	78
AM1PRL-2415SNZ	24 (18-36)	15	10	57	67	680	78
AM1PRL-2424SNZ	24 (18-36)	24	10	57	42	470	77

Note: Use prefix "L" for SMD package (ex. AM1PRL-1205SNZ).

Dual Output							
Model	Input Voltage (VDC)	Output Voltage (VDC)	Nominal Vin Input Current Max (mA)		Output Current Max (mA)	Maximum Capacitive Load (μF)	Efficiency Full Load Typ (%)
			No Load	Full Load			
AM1PR-1205DNZ	12 (9-18)	±5	30	112	±100	1000	77
AM1PR-1209DNZ	12 (9-18)	±9	30	112	±56	680	80
AM1PR-1212DNZ	12 (9-18)	±12	30	112	±42	470	80
AM1PR-1215DNZ	12 (9-18)	±15	30	112	±33	330	77
AM1PR-2405DNZ	24 (18-36)	±5	12	56	±100	1000	77
AM1PR-2409DNZ	24 (18-36)	±9	12	56	±56	680	77
AM1PR-2412DNZ	24 (18-36)	±12	12	56	±42	470	77
AM1PR-2415DNZ	24 (18-36)	±15	12	56	±33	330	77
AM1PRL-1205DNZ	12 (9-18)	±5	30	112	±100	1000	77
AM1PRL-1209DNZ	12 (9-18)	±9	30	112	±56	680	80
AM1PRL-1212DNZ	12 (9-18)	±12	30	112	±42	470	80
AM1PRL-1215DNZ	12 (9-18)	±15	30	112	±33	330	77
AM1PRL-2405DNZ	24 (18-36)	±5	12	56	±100	1000	77
AM1PRL-2409DNZ	24 (18-36)	±9	12	56	±56	680	77
AM1PRL-2412DNZ	24 (18-36)	±12	12	56	±42	470	77
AM1PRL-2415DNZ	24 (18-36)	±15	12	56	±33	330	77

Note: Use prefix "L" for SMD package (ex. AM1PRL-1205DNZ).

Input Specification				
Parameters	Conditions	Typical	Maximum	Units
Input voltage	Nominal 12V	9-18	20	VDC
	Nominal 24V	18-36	40	VDC
Absolute maximum rating	Nominal 12V, 1s max.	≥-0.7	25	VDC
	Nominal 24V, 1s max.	≥-0.7	50	VDC
Start-up voltage	Nominal 12V		9	VDC
	Nominal 24V		18	VDC
Input reflected current	Nominal 12V	40		mA
	Nominal 24V	55		mA
Input filter	Capacitor filter			

Isolation Specification				
Parameters	Conditions	Typical	Maximum	Units
Tested isolation voltage	Input / output 60 sec, ≤ 1mA	≥1500		VDC
Resistance	500VDC	≥1000		MΩ
Capacitance	100KHz / 0.1V	100		pF

Output Specification				
Parameters	Conditions	Typical	Maximum	Units
Voltage accuracy	5% -100% load, single and dual output 1	±1	±3	%
	5% -100% load, output 2	±3	±5	%
	0% load, single output, 3.3Vout	±5	±7	%
	0% load, single output, others	±1.5	±5	%
	0% load, dual output, output 1	±2	±5	%
	0% load, dual output, output 2		±8	%
Line regulation	LL – HL 100% load, single output	±0.2	±0.5	%
	LL – HL 5% -100% load, dual output, output 1	±0.2	±0.5	%
	LL – HL 5% -100% load, dual output, output 2	±0.5	±1	%
Load regulation	5% -100% load, single and dual output 1	±0.5	±1	%
	5% -100% load, output 2		±2	%
Short circuit protection	Continues, Auto recovery			
Transient Recovery Time	25% load step change	1	3	ms
Transient Response Deviation	25% load step change, single output	±2.5	±5	%
	25% load step change, dual output	±3	±5	%
Ripple & Noise	20MHz bandwidth, 5% -100% load, 24Vin single output	50	100	mV pk-pk
	20MHz bandwidth, 5% -100% load, 24Vin dual output	70	100	mV pk-pk
	20MHz bandwidth, 5% -100% load, others	100	150	mV pk-pk
Minimum load		5		%

General Specifications				
Parameters	Conditions	Typical	Maximum	Units
Switching frequency		300		KHz
Operating temperature	Without derating	-40 to +85		°C
Storage temperature		-55 to +125		°C
Soldering temperature	1.5mm distance, ≤ 10s		300	°C
Reflow temperature	Over 217°C for less than 60s		245	°C

Reflow method	IPC/JEDEC J-STD-020D.1.		
Temperature coefficient	100% Load		± 0.03 %/ °C
Cooling	Free air convection		
Humidity	Non-condensing	≥5	95 % RH
Weight		2.2	g
Dimensions (L x W x H)	DIP	0.55 x 0.55 x 0.35 inches (14.0 x 14.0 x 9.0 mm)	
	SMD	0.59 x 0.55 x 0.36 inches (15.0 x 14.0 x 9.1 mm)	
Case material	Black plastic		
MTBF	≥ 1 000 000 hrs (MIL-HDBK -217F, t=+25°C)		
NOTE: All specifications in this datasheet are measured at an ambient temperature of 25°C, humidity<75%, nominal input voltage and at rated output load unless otherwise specified.			

Safety Specifications		
Parameters		
Standards	Design to meet EN62368	
	EMI - Conducted and radiated emission	CISPR32/EN55032 Class B with the recommended EMC circuit part B
	Electrostatic Discharge Immunity	IEC/EN 61000-4-2, Contact ±6KV, Criteria B
	RF, Electromagnetic Field Immunity	IEC/EN 61000-4-3, 10V/m, Criteria A
	Electrical Fast Transient/Burst Immunity	IEC/EN 61000-4-4, ±2KV, Criteria B with the recommended EMC circuit part A
	Surge Immunity	IEC/EN 61000-4-5, L-L ±2KV, Criteria B with the recommended EMC circuit part A
	RF, Conducted Disturbance Immunity	IEC/EN 61000-4-6, 3Vr.m.s, Criteria A

Typical application circuit

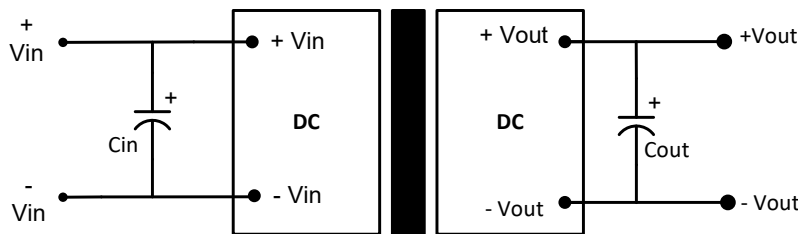

Vin	Cin
12	47µF/25V
24	47µF/50V

Vout	Cout
3.3/5	100µF/6.3V
9/12/15/24	27µF/35V

Recommended EMC circuit

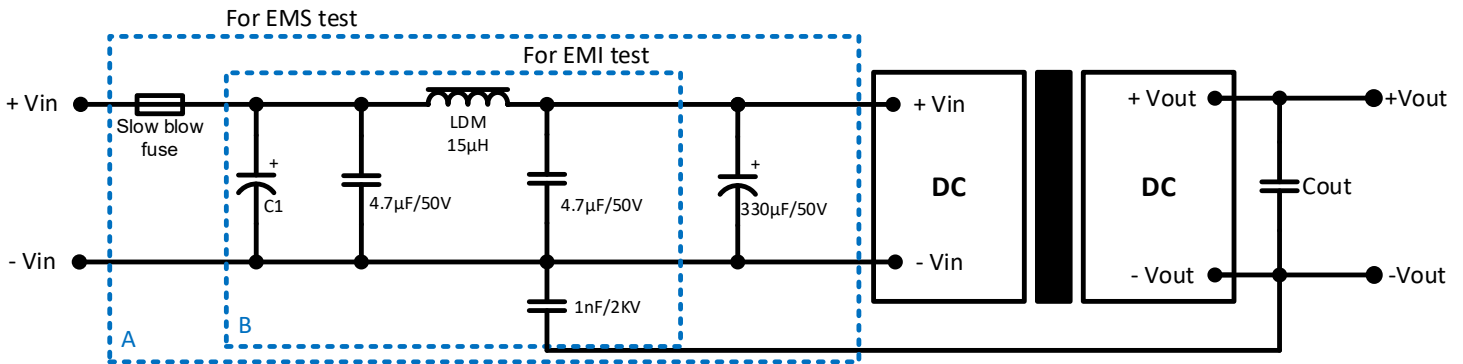

Vin	C1
12	1000µF/25V
24	680µF/50V

Dimension

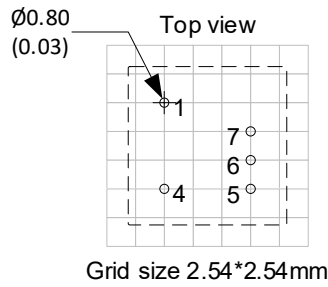
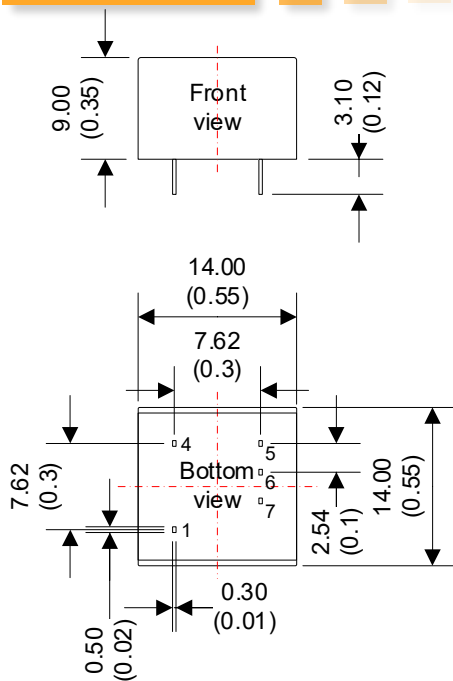

Dimensions: mm (inch)
General Tolerance: ± 0.50 (0.02)
Pin diameter Tolerance: ± 0.10 (0.004)

Pin Out Specifications		
Pin	Single	Dual
1	-Vin	-Vin
4	+Vin	+Vin
5	+Vout	+Vout
6	NC	0V
7	-Vout	-Vout

Dimension for L models

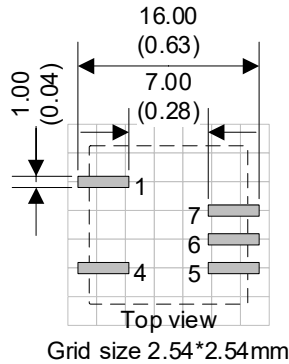
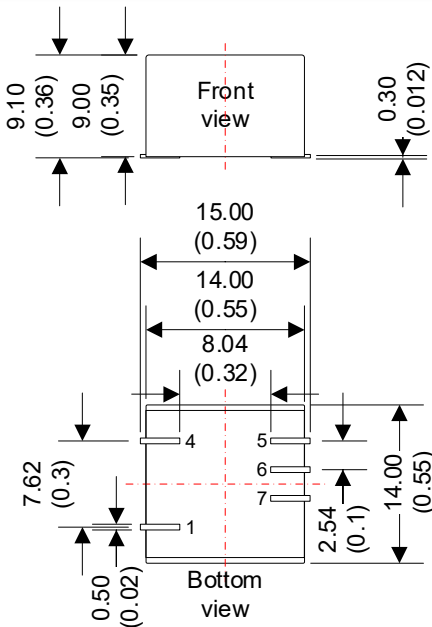

Dimensions: mm (inch)
General Tolerance: ± 0.50 (0.02)
Pin diameter Tolerance: ± 0.10 (0.004)

NOTE: 1. Datasheets are updated as needed and as such, specifications are subject to change without notice. Once printed or downloaded, datasheets are no longer controlled by Aimtec; refer to www.aimtec.com for the most current product specifications. 2. Product labels shown, including safety agency certifications on labels, may vary based on the date manufactured. 3. Mechanical drawings and specifications are for reference only. 4. All specifications are measured at an ambient temperature of 25°C, humidity < 75%, nominal input voltage and at rated output load unless otherwise specified. 5. Aimtec may not have conducted destructive testing or chemical analysis on all internal components and chemicals at the time of publishing this document. CAS numbers and other limited information are considered proprietary and may not be available for release. 6. This product is not designed for use in critical life support systems, equipment used in hazardous environments, nuclear control systems or other such applications which necessitate specific safety and regulatory standards other than the ones listed in this datasheet. 7. Warranty is in accordance with Aimtec's standard Terms of Sale available at www.aimtec.com.