

High-Performance Single 150 mA LDO

Features

- 2.5V to 5.5V Input Voltage Range
- 150 mA Guaranteed Output Current
- Stable with 1 μ F Ceramic Output Capacitors
- Low Dropout Voltage (155 mV at 150 mA)
- Excellent Load/Line Transient Response
- Low Quiescent Current: 29 μ A
- High PSRR: 70 dB
- Output Discharge Circuit: MIC5366
- High Output Accuracy
 - \pm 2% Initial Accuracy
- Thermal Shutdown and Current Limit Protection
- Tiny 1 mm \times 1 mm Thin DFN, SC-70-5, and Thin SOT23-5 Packages

Applications

- Mobile Phones
- Digital Cameras
- GPS, PMP, PDAs, and Handhelds
- Portable Electronics

General Description

The MIC5365/6 are advanced general purpose linear regulators offering high power supply rejection (PSRR) in an ultra-small 1 mm \times 1 mm package. The MIC5366 includes an auto-discharge feature that is activated when the enable pin is low. The MIC5365/6 is capable of sourcing 150 mA output current and offers high PSRR making it an ideal solution for any portable electronic application.

Ideal for battery-powered applications, the MIC5365/6 offers 2% initial accuracy, low dropout voltage (155 mV @ 150 mA), and low ground current (typically 29 μ A). The MIC5365/6 can also be put into a zero-off-mode current state, drawing virtually no current when disabled.

The MIC5365/6 is available in several advanced packages including a lead-free (RoHS-compliant) 1 mm \times 1 mm Thin DFN occupying only 1 mm² of PCB area, a 75% reduction in board area compared to SC-70 and 2 mm \times 2 mm TDFN packages. It is also available in a thin SOT23-5 package.

The MIC5365/6 have an operating junction temperature range of -40°C to 125°C .

Package Types

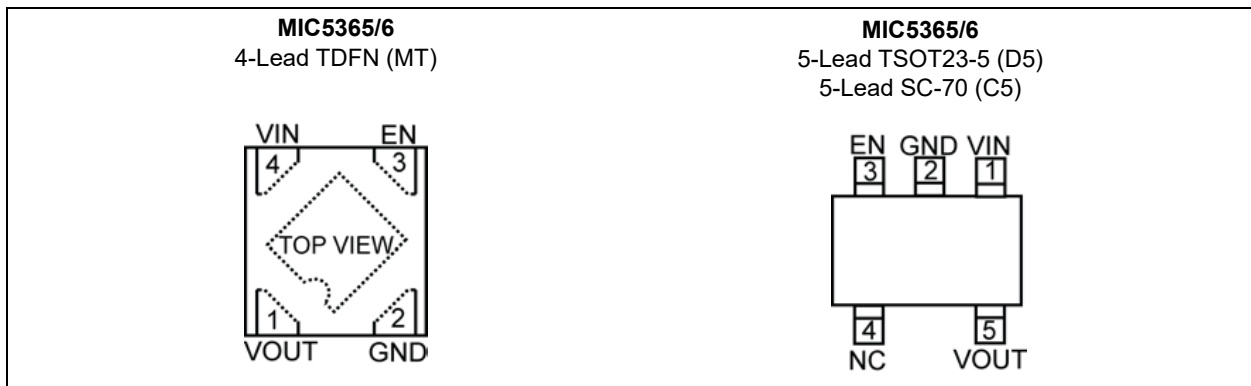

MIC5365/6

Typical Application Circuit

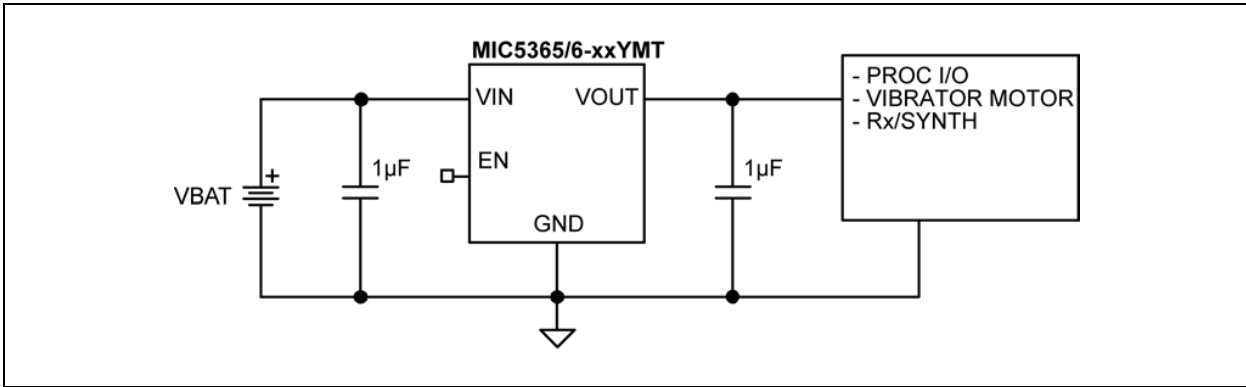

Functional Block Diagrams

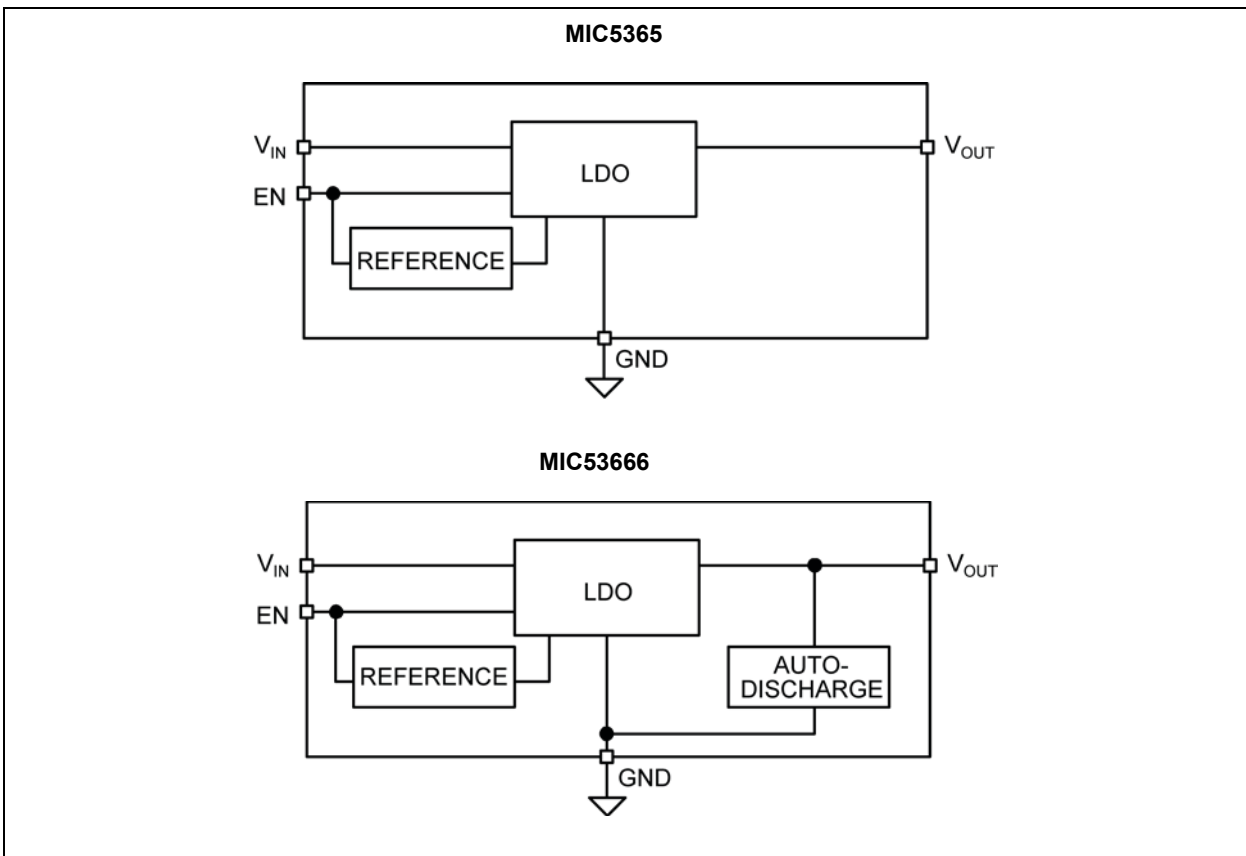

1.0 ELECTRICAL CHARACTERISTICS

Absolute Maximum Ratings †

Supply Voltage (V_{IN})	0V to +6V
Enable Voltage (V_{EN})	0V to V_{IN}
Power Dissipation (P_D), Note 1	Internally Limited
ESD Rating, Note 2	2 kV

Operating Ratings ‡

Supply Voltage (V_{IN})	+2.5V to +5.5V
Enable Voltage (V_{EN})	0V to V_{IN}

† **Notice:** Stresses above those listed under “Absolute Maximum Ratings” may cause permanent damage to the device. This is a stress rating only and functional operation of the device at those or any other conditions above those indicated in the operational sections of this specification is not intended. Exposure to maximum rating conditions for extended periods may affect device reliability.

‡ **Notice:** The device is not guaranteed to function outside its operating ratings.

Note 1: The maximum allowable power dissipation of any T_A (ambient temperature) is $P_{D(MAX)} = (T_{J(MAX)} - T_A)/\theta_{JA}$. Exceeding the maximum allowable power dissipation will result in excessive die temperature, and the regulator will go into thermal shutdown.

2: Devices are ESD sensitive. Handling precautions are recommended. Human body model, 1.5 k Ω in series with 100 pF.

ELECTRICAL CHARACTERISTICS

Electrical Characteristics: $V_{IN} = V_{EN} = V_{OUT} + 1V$; $C_{IN} = C_{OUT} = 1 \mu F$; $I_{OUT} = 100 \mu A$; $T_A = +25^\circ C$; **Bold** values are valid for $-40^\circ C$ to $+125^\circ C$ unless noted. ([Note 1](#)).

Parameters	Symbol	Min.	Typ.	Max.	Units	Conditions
Output Voltage Accuracy	V_{OUT}	-2.0	—	+2.0	%	Variation from nominal V_{OUT}
		-3.0	—	+3.0		Variation from nominal V_{OUT} ; $-40^\circ C$ to $+125^\circ C$
Line Regulation	$\frac{\Delta V_{OUT}}{V_{OUT}}$	—	0.02	0.3	%	$V_{IN} = V_{OUT} + 1V$ to 5.5V; $I_{OUT} = 100 \mu A$
Load Regulation	$\frac{\Delta V_{OUT}}{V_{OUT}}$	—	0.3	1	%	$I_{OUT} = 100 \mu A$ to 150 mA
Dropout Voltage	V_{DO}	—	55	110	mV	$I_{OUT} = 50 \text{ mA}$; $V_{OUT} \geq 2.8V$
		—	155	310		$I_{OUT} = 150 \text{ mA}$; $V_{OUT} \geq 2.8V$
		—	60	135		$I_{OUT} = 50 \text{ mA}$; $V_{OUT} < 2.8V$
		—	180	380		$I_{OUT} = 150 \text{ mA}$; $V_{OUT} < 2.8V$
Ground Pin Current	I_{GND}	—	29	39	μA	$I_{OUT} = 0 \text{ mA}$
Ground Pin Current in Shutdown	I_{SHDN}	—	0.05	1	μA	$V_{EN} \leq 0.2V$
Ripple Rejection	PSRR	—	80	—	dB	$f = \text{up to } 1 \text{ kHz}$; $C_{OUT} = 1 \mu F$
		—	65	—		$f = 1 \text{ kHz to } 10 \text{ kHz}$, $C_{OUT} = 1 \mu F$
Current Limit	I_{LIM}	200	325	550	mA	$V_{OUT} = 0V$
Output Voltage Noise	e_N	—	200	—	μV_{RMS}	$C_{OUT} = 1 \mu F$, 10 Hz to 100 kHz
Auto-Discharge NFET Resistance	R_{DSCG}	—	30	—	Ω	MIC5366 Only; $V_{EN} = 0V$; $V_{IN} = 3.6V$, $I_{OUT} = -3 \text{ mA}$
Enable Inputs						
Enable Input Voltage	V_{IL}	—	—	0.2	V	Logic Low
	V_{IH}	1.2	—	—		Logic High

MIC5365/6

ELECTRICAL CHARACTERISTICS

Electrical Characteristics: $V_{IN} = V_{EN} = V_{OUT} + 1V$; $C_{IN} = C_{OUT} = 1 \mu F$; $I_{OUT} = 100 \mu A$; $T_A = +25^\circ C$; **Bold** values are valid for $-40^\circ C$ to $+125^\circ C$ unless noted. (**Note 1**).

Parameters	Symbol	Min.	Typ.	Max.	Units	Conditions
Enable Input Current	I_{IL}	—	0.01	1	μA	$V_{IL} \leq 0.2V$
	I_{IH}	—	0.01	1		$V_{IH} \geq 1.2V$
Turn-On Time	t_{ON}	—	50	125	μs	$C_{OUT} = 1 \mu F$; $I_{OUT} = 150 mA$

Note 1: Specification for packaged product only.

TEMPERATURE SPECIFICATIONS

Parameters	Symbol	Min.	Typ.	Max.	Units	Conditions
Temperature Ranges						
Maximum Junction Temperature Range	$T_{J(MAX)}$	-40	—	+150	$^\circ C$	Note 1
Storage Temperature Range	T_S	-65	—	+150	$^\circ C$	—
Lead Temperature	—	—	—	+260	$^\circ C$	Soldering, 3 sec.
Junction Temperature	T_J	-40	—	+125	$^\circ C$	—
Package Thermal Resistances						
Thermal Resistance, TDFN-4	θ_{JA}	—	240	—	$^\circ C/W$	—
Thermal Resistance, TSOT23-5		—	253	—		
Thermal Resistance, SC-70-5		—	256.5	—		

Note 1: The maximum allowable power dissipation is a function of ambient temperature, the maximum allowable junction temperature and the thermal resistance from junction to air (i.e., T_A , T_J , θ_{JA}). Exceeding the maximum allowable power dissipation will cause the device operating junction temperature to exceed the maximum $+125^\circ C$ rating. Sustained junction temperatures above $+125^\circ C$ can impact the device reliability.

2.0 TYPICAL PERFORMANCE CURVES

Note: The graphs and tables provided following this note are a statistical summary based on a limited number of samples and are provided for informational purposes only. The performance characteristics listed herein are not tested or guaranteed. In some graphs or tables, the data presented may be outside the specified operating range (e.g., outside specified power supply range) and therefore outside the warranted range.

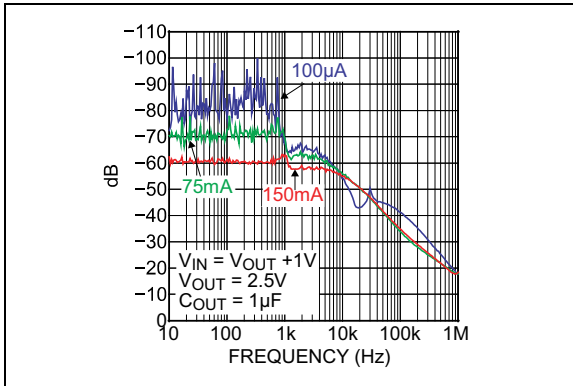

FIGURE 2-1: Power Supply Rejection Ratio.

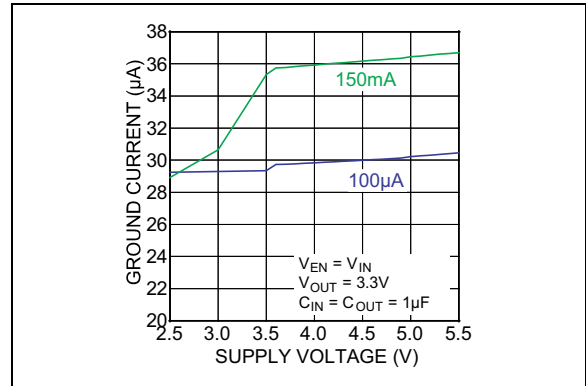

FIGURE 2-4: Ground Current vs. Supply Voltage.

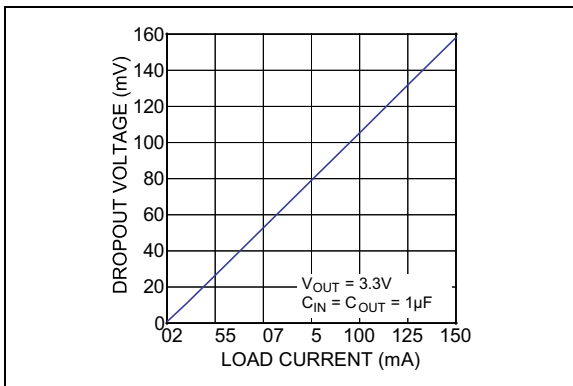

FIGURE 2-2: Dropout Voltage vs. Load Current.

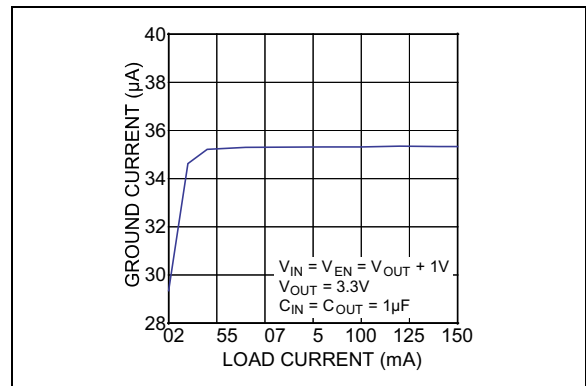

FIGURE 2-5: Ground Current vs. Load Current.

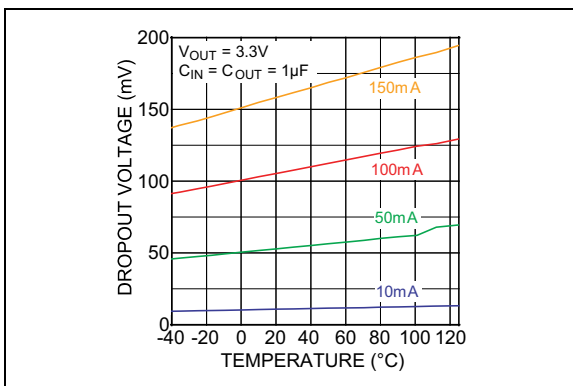

FIGURE 2-3: Dropout Voltage vs. Temperature.

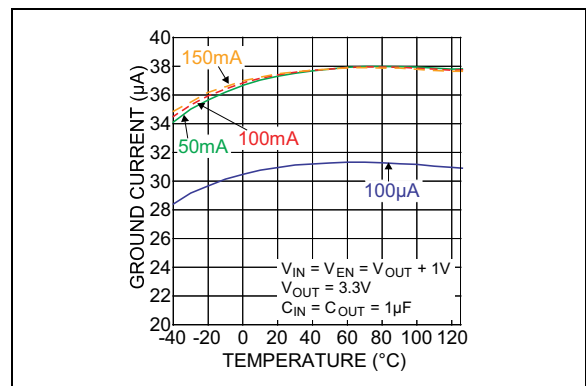

FIGURE 2-6: Ground Current vs. Temperature.

MIC5365/6

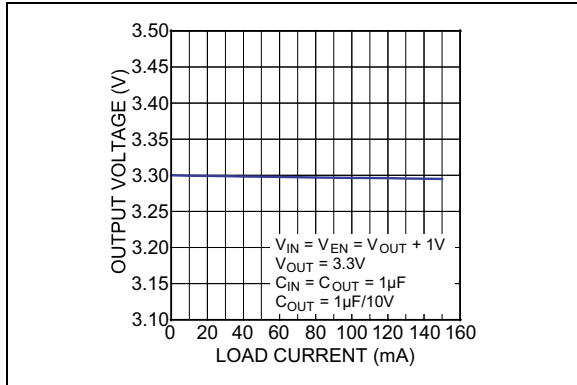

FIGURE 2-7: Output Voltage vs. Load Current.

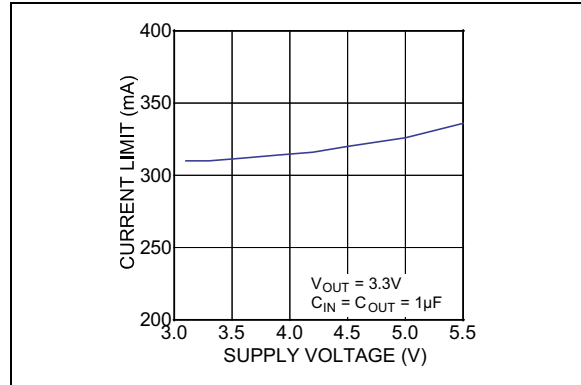

FIGURE 2-10: Current Limit vs. Supply Voltage.

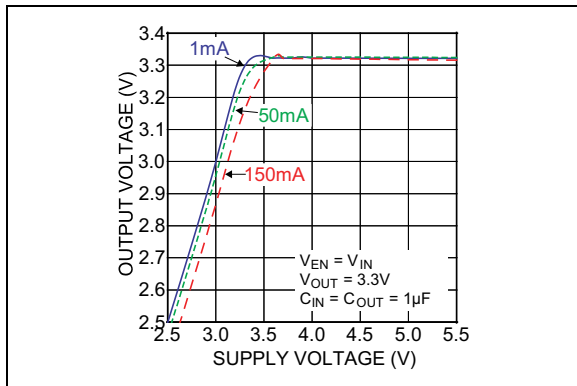

FIGURE 2-8: Output Voltage vs. Supply Voltage.

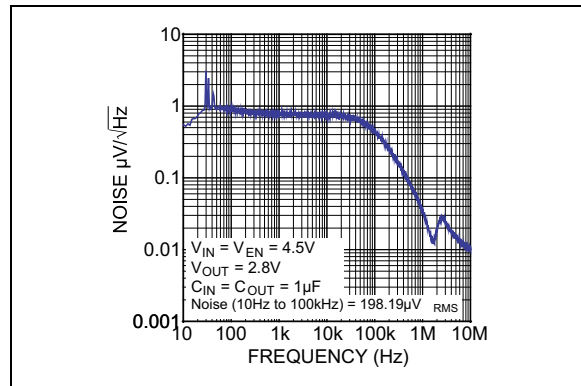

FIGURE 2-11: Output Noise Spectral Density.

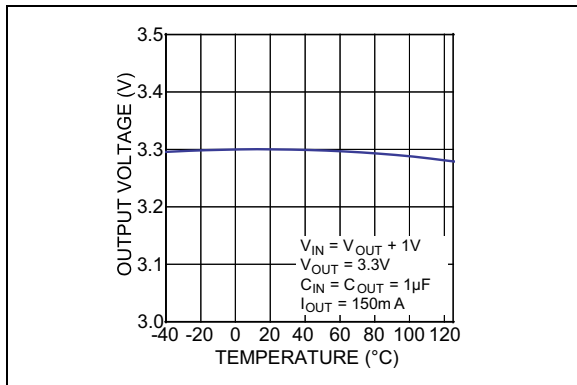

FIGURE 2-9: Output Voltage vs. Temperature.

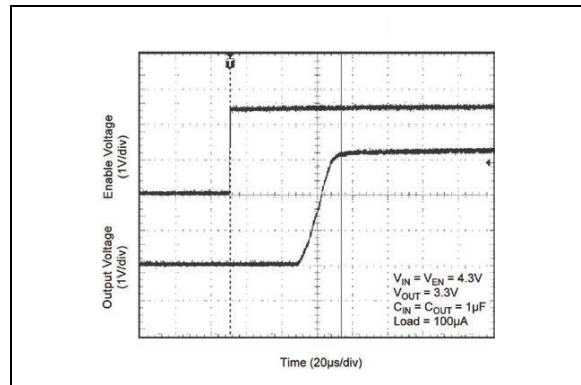

FIGURE 2-12: Enable Turn-On.

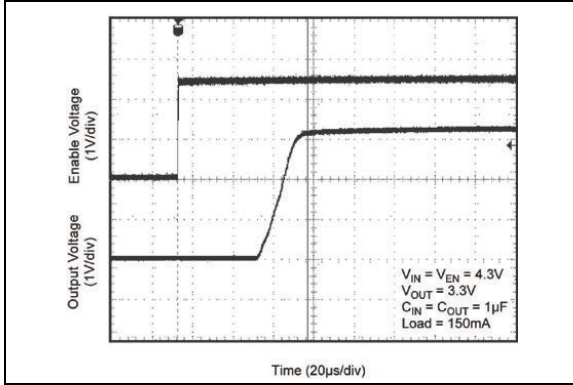

FIGURE 2-13: Enable Turn-On.

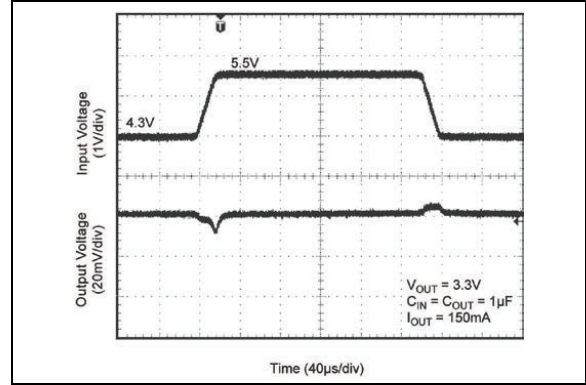

FIGURE 2-16: Line Transient.

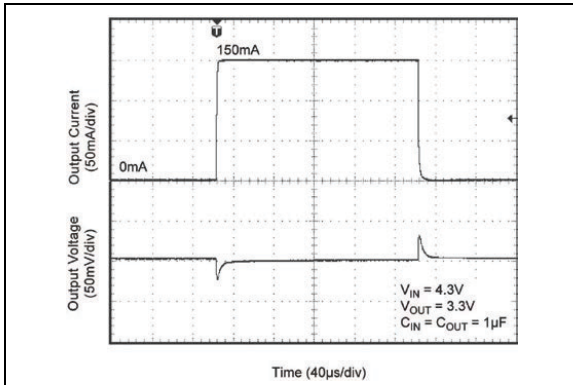

FIGURE 2-14: Load Transient.

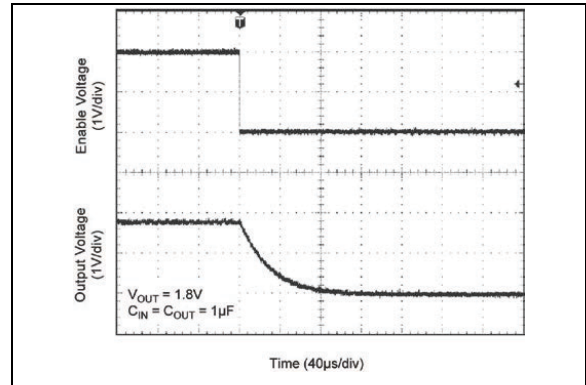

FIGURE 2-17: MIC5366 Auto Discharge (No Load).

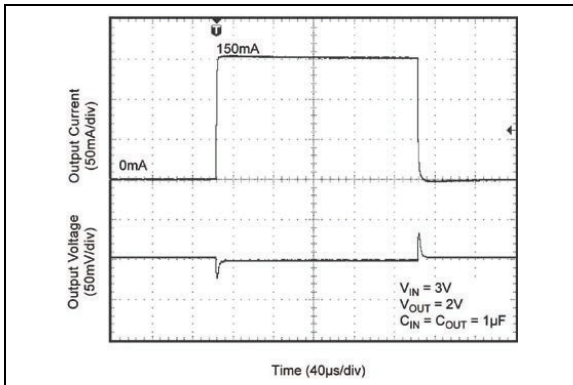

FIGURE 2-15: Load Transient.

MIC5365/6

3.0 PIN DESCRIPTIONS

The descriptions of the pins are listed in [Table 3-1](#).

TABLE 3-1: PIN FUNCTION TABLE

Pin Number	Pin Name TDFN-4	Pin Name TSOT23-5	Pin Name SC70-5	Description
1	VOUT	—	—	Output Voltage.
1	—	VIN	VIN	Supply Input.
2	GND	GND	GND	Ground.
3	EN	EN	EN	Enable Input: Active-high. High = ON; Low = OFF. Do not leave floating.
4	VIN	—	—	Supply Input.
4	—	NC	NC	No Connect. Not internally connected.
5	—	VOUT	VOUT	Output Voltage.
EP	HS Pad	N/A	N/A	Exposed heat sink pad.

4.0 APPLICATION INFORMATION

MIC5365 and MIC5366 are low noise 150 mA LDOs. The MIC5366 includes an auto-discharge circuit that is switched on when the regulator is disabled through the enable pin. The MIC5365/6 regulator is fully protected from damage due to fault conditions, offering linear current limiting and thermal shutdown.

4.1 Input Capacitor

The MIC5365/6 is a high-performance, high-bandwidth device. An input capacitor of 1 μF capacitor is required from the input to ground to provide stability. Low-ESR ceramic capacitors provide optimal performance at a minimum of space. Additional high-frequency capacitors, such as small valued NPO dielectric type capacitors, help filter out high-frequency noise and are good practice in any RF-based circuit. X5R or X7R dielectrics are recommended for the input capacitor. Y5V dielectrics lose most of their capacitance over temperature and are therefore, not recommended.

4.2 Output Capacitor

The MIC5365/6 requires an output capacitor of 1 μF or greater to maintain stability. The design is optimized for use with low-ESR ceramic chip capacitors. High-ESR capacitors may cause high frequency oscillation. The output capacitor can be increased, but performance has been optimized for a 1 μF ceramic output capacitor and does not improve significantly with larger capacitance.

X7R/X5R dielectric-type ceramic capacitors are recommended because of their temperature performance. X7R type capacitors change capacitance by 15% over their operating temperature range and are the most stable type of ceramic capacitors. Z5U and Y5V dielectric capacitors change value by as much as 50% and 60%, respectively, over their operating temperature ranges. To use a ceramic chip capacitor with Y5V dielectric, the value must be much higher than an X7R ceramic capacitor to ensure the same minimum capacitance over the equivalent operating temperature range.

4.3 No-Load Stability

Unlike many other voltage regulators, the MIC5365/6 will remain stable and in regulation with no load. This is especially important in CMOS RAM to keep applications alive.

4.4 Enable/Shutdown

The MIC5365/6 comes with an active-high enable pin that allows the regulator to be disabled. Forcing the enable pin low disables the regulator and sends it into a “zero” off-mode current state. In this state, current consumed by the regulator goes nearly to zero. Forcing

the enable pin high enables the output voltage. The active-high enable pin uses CMOS technology and the enable pin cannot be left floating; a floating enable pin may cause an indeterminate state on the output.

4.5 Thermal Considerations

The MIC5365/6 is designed to provide 150 mA of continuous current in a very small package. Maximum ambient operating temperature can be calculated based on the output current and the voltage drop across the part. For example if the input voltage is 3.6V, the output voltage is 2.8V, and the output current = 150 mA. The actual power dissipation of the regulator circuit can be determined using the equation [Equation 4-1](#):

EQUATION 4-1:

$$P_D = (V_{IN} - V_{OUT})I_{OUT} + V_{IN} \times I_{GND}$$

Because this device is CMOS and the ground current is typically <100 μA over the load range, the power dissipation contributed by the ground current is <1% and can be ignored for the calculation in [Equation 4-2](#):

EQUATION 4-2:

$$P_D = (3.6V - 2.8V) \times 150mA$$

$$P_D = 0.120W$$

To determine the maximum ambient operating temperature of the package, use the junction-to-ambient thermal resistance of the device and the following basic formula in [Equation 4-3](#):

EQUATION 4-3:

$$P_{D(MAX)} = \left(\frac{T_{J(MAX)} - T_A}{\theta_{JA}} \right)$$

Where:

$$T_{J(MAX)} = \begin{array}{l} 125^\circ\text{C} \\ 240^\circ\text{C/W (YMT Package)} \end{array}$$

$$\theta_{JA} = \begin{array}{l} 256.5^\circ\text{C/W (SC-70-5 Package)} \\ 235^\circ\text{C/W (TSOT23-5 Package)} \end{array}$$

MIC5365/6

Substituting P_D for $P_{D(MAX)}$ and solving for the ambient operating temperature will give the maximum operating conditions for the regulator circuit. The junction-to-ambient thermal resistance for the minimum footprint is $250^\circ\text{C}/\text{W}$.

The maximum power dissipation must not be exceeded for proper operation.

For example, when operating the MIC5365-2.8YMT at an input voltage of 3.6V and 150 mA loads at each output with a minimum footprint layout, the maximum ambient operating temperature T_A can be determined in [Equation 4-4](#):

EQUATION 4-4:

$$0.120\text{ W} = (125^\circ\text{C} - T_A)/(250^\circ\text{C}/\text{W})$$

$$T_A = 95^\circ\text{C}$$

Therefore, the maximum ambient operating temperature of 95°C is allowed in a $1\text{ mm} \times 1\text{ mm}$ TDFN package. For a full discussion of heat sinking and thermal effects of voltage regulators, refer to the "Regulator Thermals" section of [Designing with Low-Dropout Voltage Regulators handbook](#).

5.0 PACKAGING INFORMATION

5.1 Package Marking Information

4-Lead TDFN*

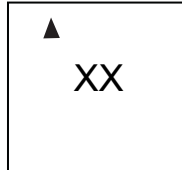

Example

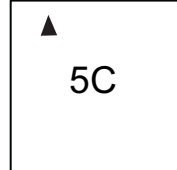

5-Lead SC70-5*
5-Lead TSOT23-5*

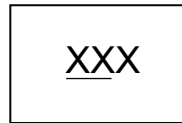

Example

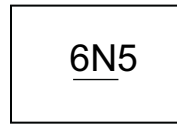

<p>Legend:</p> <p>XX...X Product code or customer-specific information</p> <p>Y Year code (last digit of calendar year)</p> <p>YY Year code (last 2 digits of calendar year)</p> <p>WW Week code (week of January 1 is week '01')</p> <p>NNN Alphanumeric traceability code</p> <p>(e3) Pb-free JEDEC® designator for Matte Tin (Sn)</p> <p>* This package is Pb-free. The Pb-free JEDEC designator ((e3)) can be found on the outer packaging for this package.</p> <p>•, ▲, ▼ Pin one index is identified by a dot, delta up, or delta down (triangle mark).</p>	<p>Note: In the event the full Microchip part number cannot be marked on one line, it will be carried over to the next line, thus limiting the number of available characters for customer-specific information. Package may or may not include the corporate logo.</p> <p>Underbar () and/or Overbar () symbol may not be to scale.</p>
---	---

MIC5365/6

TABLE 5-1: PACKAGE MARKING CODES FOR MIC5363/65

Part Number	Output Voltage	Marking Codes
MIC5365-1.0YMT	1.0V	5C
MIC5365-1.2YMT	1.2V	54
MIC5365-1.3YMT	1.3V	55
MIC5365-1.5YMT	1.5V	5F
MIC5365-1.8YMT	1.8V	5G
MIC5365-2.0YMT	2.0V	5H
MIC5365-2.5YMT	2.5V	5J
MIC5365-2.6YMT	2.6V	5K
MIC5365-2.7YMT	2.7V	5L
MIC5365-2.8YMT	2.8V	5M
MIC5365-2.85YMT	2.85V	5N
MIC5365-2.9YMT	2.9V	5O
MIC5365-3.0YMT	3.0V	5P
MIC5365-3.3YMT	3.3V	5S
MIC5365-1.0YC5	1.0V	65C
MIC5365-1.2YC5	1.2V	654
MIC5365-1.3YC5	1.3V	655
MIC5365-1.5YC5	1.5V	65F
MIC5365-1.8YC5	1.8V	65G
MIC5365-2.0YC5	2.0V	65H
MIC5365-2.5YC5	2.5V	65J
MIC5365-2.6YC5	2.6V	65K
MIC5365-2.7YC5	2.7V	65L
MIC5365-2.8YC5	2.8V	65M
MIC5365-2.85YC5	2.85V	65N
MIC5365-2.9YC5	2.9V	65O
MIC5365-3.0YC5	3.0V	65P
MIC5365-3.3YC5	3.3V	65S
MIC5365-1.2YD5	1.2V	645
MIC5365-1.8YD5	1.8V	6G5
MIC5365-2.8YD5	2.8V	6M5
MIC5365-2.85YD5	2.85V	6N5
MIC5365-3.3YD5	3.3V	6S5
MIC5366-1.0YMT	1.0V	6C
MIC5366-1.2YMT	1.2V	64
MIC5366-1.3YMT	1.3V	65
MIC5366-1.5YMT	1.5V	6F
MIC5366-1.8YMT	1.8V	6G
MIC5366-2.0YMT	2.0V	6H
MIC5366-2.5YMT	2.5V	6J
MIC5366-2.6YMT	2.6V	6K
MIC5366-2.7YMT	2.7V	6L
MIC5366-2.8YMT	2.8V	6M

TABLE 5-1: PACKAGE MARKING CODES FOR MIC5363/65

Part Number	Output Voltage	Marking Codes
MIC5366-2.85YMT	2.85V	6N
MIC5366-2.9YMT	2.9V	6O
MIC5366-3.0YMT	3.0V	6P
MIC5366-3.3YMT	3.3V	6S
MIC5366-1.0YC5	1.0V	66C
MIC5366-1.2YC5	1.2V	664
MIC5366-1.3YC5	1.3V	665
MIC5366-1.5YC5	1.5V	66F
MIC5366-1.8YC5	1.8V	66G
MIC5366-2.0YC5	2.0V	66H
MIC5366-2.5YC5	2.5V	66J
MIC5366-2.6YC5	2.6V	66K
MIC5366-2.7YC5	2.7V	66L
MIC5366-2.8YC5	2.8V	66M
MIC5366-2.85YC5	2.85V	66N
MIC5366-2.9YC5	2.9V	66O
MIC5366-3.0YC5	3.0V	66P
MIC5366-3.3YC5	3.3V	66S

MIC5365/6

4-Lead TDFN Package Outline and Recommended Land Pattern

TITLE

4 LEAD TDFN 1.0x1.0mm PACKAGE OUTLINE & RECOMMENDED LAND PATTERN

DRAWING #	TDFN1010-4LD-PL-2	UNIT	MM
-----------	-------------------	------	----

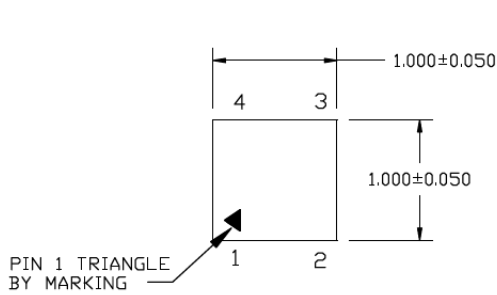

TOP VIEW

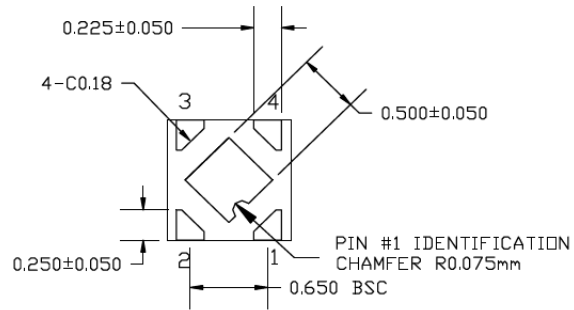

BOTTOM VIEW

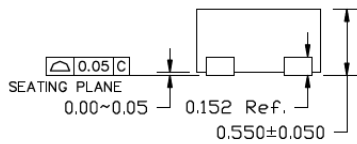

SIDE VIEW

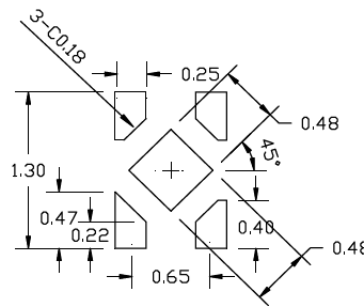

RECOMMENDED LAND PATTERN

NOTE:

1. MAX PACKAGE WARPAGE IS 0.05 MM
2. MAX ALLOWABLE BURR IS 0.076MM IN ALL DIRECTIONS
3. PIN #1 IS ON TOP WILL BE LASER MARKED
4. UNSPECIFIED TOLERANCE IS +/- 0.05 MM

Note: For the most current package drawings, please see the Microchip Packaging Specification located at <http://www.microchip.com/packaging>.

5-Lead TSOT23 Package Outline and Recommended Land Pattern

TITLE

5 LEAD TSOT PACKAGE OUTLINE & RECOMMENDED LAND PATTERN

DRAWING #	TSOT-5LD-PL-1	UNIT	MM
------------------	---------------	-------------	----

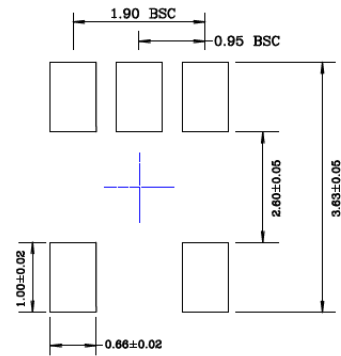
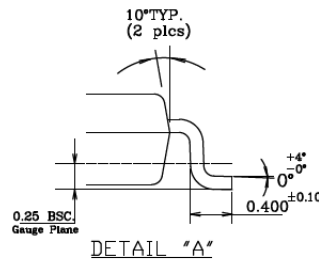
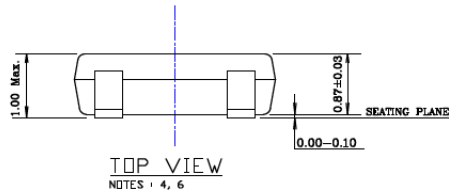
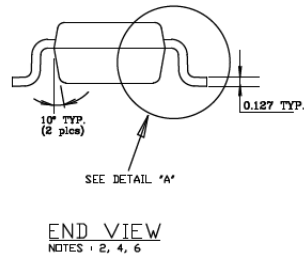
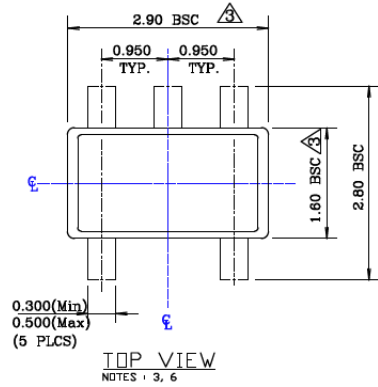

NOTE:

- Dimensions and tolerances are as per ANSI Y14.5M, 1994.
- Die is facing up for mold. Die is facing down for trim/form, ie. reverse trim/form.
- △ Dimensions are exclusive of mold flash and gate burr.
- The footlength measuring is based on the gauge plane method.
- All specification comply to Jedec Spec M0193 Issue C.
- All dimensions are in millimeters.

Note: For the most current package drawings, please see the Microchip Packaging Specification located at <http://www.microchip.com/packaging>.

MIC5365/6

5-Lead SC-70 Package Outline and Recommended Land Pattern

TITLE

5 LEAD SC70 PACKAGE OUTLINE & RECOMMENDED LAND PATTERN

DRAWING #	SC70-5LD-PL-2	UNIT	MM
------------------	---------------	-------------	----

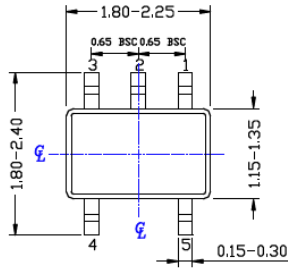

TOP VIEW

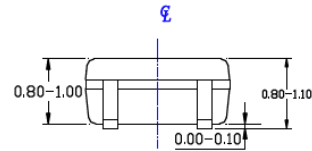

SIDE VIEW

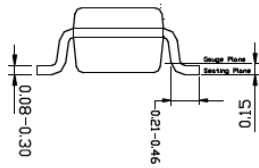

END VIEW

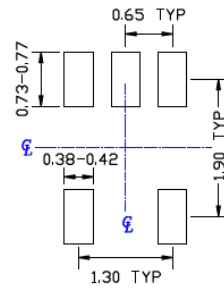

RECOMMENDED LAND PATTERN

NOTE:

1. ALL DIMENSIONS ARE IN MILLIMETERS.
2. DIMENSIONS ARE INCLUSIVE OF PLATING.
3. DIMENSIONS ARE EXCLUSIVE OF MOLD FLASH & METAL BURR.

Note: For the most current package drawings, please see the Microchip Packaging Specification located at <http://www.microchip.com/packaging>.

APPENDIX A: REVISION HISTORY

Revision A (October 2021)

- Converted Micrel document MIC5365/6 to Microchip data sheet DS20006605A.
- Minor text changes throughout.
- Evaluation Board Schematic and BOM sections from original data sheet moved to the part's Evaluation Board User's Guide.

MIC5365/6

NOTES:

PRODUCT IDENTIFICATION SYSTEM

To order or obtain information, e.g., on pricing or delivery, contact your local Microchip representative or sales office.

<u>PART NO.</u>	<u>-XXX</u>	<u>X</u>	<u>XX</u>	<u>-XX</u>	
Device	Voltage Option	Junction Temperature Range	Package	Media Type	
Device:	MIC5365: High-Performance Single 150 mA LDO MIC5366: High-Performance Single 150 mA LDO with Output Discharge Circuit				Examples: a) MIC5365-54YD5-T5 High-Performance Single 150 mA LDO, 1.2V, -40°C to +125°C, 5-Lead TSOT23-5 Package, 500/Reel b) MIC5365-5MYC5-TR High-Performance Single 150 mA LDO, 2.8V, -40°C to +125°C, 5-Lead SC-70-5 Package, 5,000/Reel c) MIC5365-65NYMT-TZ High-Performance Single 150 mA LDO, 2.85V, -40°C to +125°C, 4-Lead TDFN Package, 10,000/Reel e) MIC5366-66LYC5-TR High-Performance Single 150 mA LDO, 2.7V, -40°C to +125°C, 5-Lead SC-70-5 Package, 5,000/Reel f) MIC5366-66OYMT-TZ High-Performance Single 150 mA LDO, 2.9V, -40°C to +125°C, 4-Lead TDFN Package, 10,000/Reel Note 1: Tape and Reel identifier only appears in the catalog part number description. This identifier is used for ordering purposes and is not printed on the device package. Check with your Microchip Sales Office for package availability with the Tape and Reel option.
Voltage Options	5C = 1.0V (MIC5365)	6C = 1.0V (MIC5366)			
	54 = 1.2V (MIC5365)	64 = 1.2V (MIC5366)			
	55 = 1.3V (MIC5365)	65 = 1.3V (MIC5366)			
	5F = 1.5V (MIC5365)	6F = 1.5V (MIC5366)			
	5G = 1.8V (MIC5365)	6G = 1.8V (MIC5366)			
	5H = 2.0V (MIC5365)	6H = 2.0V (MIC5366)			
	5J = 2.5V (MIC5365)	6J = 2.5V (MIC5366)			
	5K = 2.6V (MIC5365)	6K = 2.6V (MIC5366)			
	5L = 2.7V (MIC5365)	6L = 2.7V (MIC5366)			
	5M = 2.8V (MIC5365)	6M = 2.8V (MIC5366)			
	5N = 2.85V (MIC5365)	6N = 2.85V (MIC5366)			
	5O = 2.9V (MIC5365)	6O = 2.9V (MIC5366)			
	5P = 3.0V (MIC5365)	6P = 3.0V (MIC5366)			
	5S = 3.3V (MIC5365)	6Q = 3.0V (MIC5366)			
	65C = 1.0V (MIC5365)	6S = 3.3V (MIC5366)			
	654 = 1.2V (MIC5365)	66C = 1.0V (MIC5366)			
	655 = 1.3V (MIC5365)	664 = 1.2V (MIC5366)			
	65F = 1.5V (MIC5365)	665 = 1.3V (MIC5366)			
	65G = 1.8V (MIC5365)	66F = 1.5V (MIC5366)			
	65H = 2.0V (MIC5365)	66G = 1.8V (MIC5366)			
	65J = 2.5V (MIC5365)	66H = 2.0V (MIC5366)			
	65K = 2.6V (MIC5365)	66J = 2.5V (MIC5366)			
	65L = 2.7V (MIC5365)	66K = 2.6V (MIC5366)			
	65M = 2.8V (MIC5365)	66L = 2.7V (MIC5366)			
	65N = 2.85V (MIC5365)	66M = 2.8V (MIC5366)			
	65O = 2.9V (MIC5365)	66N = 2.85V (MIC5366)			
	65P = 3.0V (MIC5365)	66O = 2.9V (MIC5366)			
	65S = 3.3V (MIC5365)	66P = 3.0V (MIC5366)			
	645 = 1.2V (MIC5365)	66S = 3.3V (MIC5366)			
	6G5 = 1.8V (MIC5365)				
	6M5 = 2.8V (MIC5365)				
	6N5 = 2.85V (MIC5365)				
	6S5 = 3.3V (MIC5365)				
Junction Temperature Range:	Y	= -40°C to +125°C (RoHS Compliant)			
Package:	MT	= 4-Lead 1 mm x 1 mm Thin DFN Package (Pb-Free) (MIC5365/6)			
	C5	= 5-Lead SC-70 Package (Pb-Free) (MIC5365/6)			
	D5	= 5-Lead TSOT-23 Package (Pb-Free) (MIC5365) Only			
Media Type:	T5	= 500/Reel			
	TR	= 5,000/Reel			
	TZ	= 10,000/Reel			

MIC5365/6

NOTES:

Note the following details of the code protection feature on Microchip products:

- Microchip products meet the specifications contained in their particular Microchip Data Sheet.
- Microchip believes that its family of products is secure when used in the intended manner, within operating specifications, and under normal conditions.
- Microchip values and aggressively protects its intellectual property rights. Attempts to breach the code protection features of Microchip product is strictly prohibited and may violate the Digital Millennium Copyright Act.
- Neither Microchip nor any other semiconductor manufacturer can guarantee the security of its code. Code protection does not mean that we are guaranteeing the product is “unbreakable”. Code protection is constantly evolving. Microchip is committed to continuously improving the code protection features of our products.

This publication and the information herein may be used only with Microchip products, including to design, test, and integrate Microchip products with your application. Use of this information in any other manner violates these terms. Information regarding device applications is provided only for your convenience and may be superseded by updates. It is your responsibility to ensure that your application meets with your specifications. Contact your local Microchip sales office for additional support or, obtain additional support at <https://www.microchip.com/en-us/support/design-help/client-support-services>.

THIS INFORMATION IS PROVIDED BY MICROCHIP "AS IS". MICROCHIP MAKES NO REPRESENTATIONS OR WARRANTIES OF ANY KIND WHETHER EXPRESS OR IMPLIED, WRITTEN OR ORAL, STATUTORY OR OTHERWISE, RELATED TO THE INFORMATION INCLUDING BUT NOT LIMITED TO ANY IMPLIED WARRANTIES OF NON-INFRINGEMENT, MERCHANTABILITY, AND FITNESS FOR A PARTICULAR PURPOSE, OR WARRANTIES RELATED TO ITS CONDITION, QUALITY, OR PERFORMANCE.

IN NO EVENT WILL MICROCHIP BE LIABLE FOR ANY INDIRECT, SPECIAL, PUNITIVE, INCIDENTAL, OR CONSEQUENTIAL LOSS, DAMAGE, COST, OR EXPENSE OF ANY KIND WHATSOEVER RELATED TO THE INFORMATION OR ITS USE, HOWEVER CAUSED, EVEN IF MICROCHIP HAS BEEN ADVISED OF THE POSSIBILITY OR THE DAMAGES ARE FORESEEABLE. TO THE FULLEST EXTENT ALLOWED BY LAW, MICROCHIP'S TOTAL LIABILITY ON ALL CLAIMS IN ANY WAY RELATED TO THE INFORMATION OR ITS USE WILL NOT EXCEED THE AMOUNT OF FEES, IF ANY, THAT YOU HAVE PAID DIRECTLY TO MICROCHIP FOR THE INFORMATION.

Use of Microchip devices in life support and/or safety applications is entirely at the buyer's risk, and the buyer agrees to defend, indemnify and hold harmless Microchip from any and all damages, claims, suits, or expenses resulting from such use. No licenses are conveyed, implicitly or otherwise, under any Microchip intellectual property rights unless otherwise stated.

For information regarding Microchip's Quality Management Systems, please visit www.microchip.com/quality.

Trademarks

The Microchip name and logo, the Microchip logo, Adaptec, AnyRate, AVR, AVR logo, AVR Freaks, BesTime, BitCloud, CryptoMemory, CryptoRF, dsPIC, flexPWR, HELDO, IGLOO, JukeBlox, KeeLoq, Kleer, LANCheck, LinkMD, maXStylus, maXTouch, MediaLB, megaAVR, Microsemi, Microsemi logo, MOST, MOST logo, MPLAB, OptoLyzer, PIC, picoPower, PICSTART, PIC32 logo, PolarFire, Prochip Designer, QTouch, SAM-BA, SenGenuity, SpyNIC, SST, SST Logo, SuperFlash, Symmetricom, SyncServer, Tachyon, TimeSource, tinyAVR, UNI/O, Vectron, and XMEGA are registered trademarks of Microchip Technology Incorporated in the U.S.A. and other countries.

AgileSwitch, APT, ClockWorks, The Embedded Control Solutions Company, EtherSynch, Flashtec, Hyper Speed Control, HyperLight Load, IntelliMOS, Libero, motorBench, mTouch, Powermite 3, Precision Edge, ProASIC, ProASIC Plus, ProASIC Plus logo, QuietWire, SmartFusion, SyncWorld, Temux, TimeCesium, TimeHub, TimePictra, TimeProvider, TrueTime, WinPath, and ZL are registered trademarks of Microchip Technology Incorporated in the U.S.A.

Adjacent Key Suppression, AKS, Analog-for-the-Digital Age, Any Capacitor, AnyIn, AnyOut, Augmented Switching, BlueSky, BodyCom, CodeGuard, CryptoAuthentication, CryptoAutomotive, CryptoCompanion, CryptoController, dsPICDEM, dsPICDEM.net, Dynamic Average Matching, DAM, ECAN, Espresso T1S, EtherGREEN, GridTime, IdealBridge, In-Circuit Serial Programming, ICSP, INICnet, Intelligent Paralleling, Inter-Chip Connectivity, JitterBlocker, Knob-on-Display, maxCrypto, maxView, memBrain, Mindi, MiWi, MPASM, MPF, MPLAB Certified logo, MPLIB, MPLINK, MultiTRAK, NetDetach, NVM Express, NVMe, Omniscient Code Generation, PICDEM, PICDEM.net, PICkit, PICtail, PowerSmart, PureSilicon, QMatrix, REAL ICE, Ripple Blocker, RTAX, RTG4, SAM-ICE, Serial Quad I/O, simpleMAP, SimpliPHY, SmartBuffer, SmartHLS, SMART-I.S., storClad, SQL, SuperSwitcher, SuperSwitcher II, Switchtec, SynchroPHY, Total Endurance, TSHARC, USBCheck, VariSense, VectorBlox, VeriPHY, ViewSpan, WiperLock, XpressConnect, and ZENA are trademarks of Microchip Technology Incorporated in the U.S.A. and other countries.

SQTP is a service mark of Microchip Technology Incorporated in the U.S.A.

The Adaptec logo, Frequency on Demand, Silicon Storage Technology, Symmcom, and Trusted Time are registered trademarks of Microchip Technology Inc. in other countries.

GestIC is a registered trademark of Microchip Technology Germany II GmbH & Co. KG, a subsidiary of Microchip Technology Inc., in other countries.

All other trademarks mentioned herein are property of their respective companies.

© 2021, Microchip Technology Incorporated and its subsidiaries.

All Rights Reserved.

ISBN: 978-1-5224-9211-5



MICROCHIP

Worldwide Sales and Service

AMERICAS

Corporate Office
2355 West Chandler Blvd.
Chandler, AZ 85224-6199
Tel: 480-792-7200
Fax: 480-792-7277
Technical Support:
[http://www.microchip.com/
support](http://www.microchip.com/support)
Web Address:
www.microchip.com

Atlanta

Duluth, GA
Tel: 678-957-9614
Fax: 678-957-1455

Austin, TX

Tel: 512-257-3370

Boston

Westborough, MA
Tel: 774-760-0087
Fax: 774-760-0088

Chicago

Itasca, IL
Tel: 630-285-0071
Fax: 630-285-0075

Dallas

Addison, TX
Tel: 972-818-7423
Fax: 972-818-2924

Detroit

Novi, MI
Tel: 248-848-4000

Houston, TX

Tel: 281-894-5983

Indianapolis

Noblesville, IN
Tel: 317-773-8323
Fax: 317-773-5453
Tel: 317-536-2380

Los Angeles

Mission Viejo, CA
Tel: 949-462-9523
Fax: 949-462-9608
Tel: 951-273-7800

Raleigh, NC

Tel: 919-844-7510

New York, NY

Tel: 631-435-6000

San Jose, CA

Tel: 408-735-9110
Tel: 408-436-4270

Canada - Toronto

Tel: 905-695-1980
Fax: 905-695-2078

ASIA/PACIFIC

Australia - Sydney
Tel: 61-2-9868-6733

China - Beijing
Tel: 86-10-8569-7000

China - Chengdu
Tel: 86-28-8665-5511

China - Chongqing
Tel: 86-23-8980-9588

China - Dongguan
Tel: 86-769-8702-9880

China - Guangzhou
Tel: 86-20-8755-8029

China - Hangzhou
Tel: 86-571-8792-8115

China - Hong Kong SAR
Tel: 852-2943-5100

China - Nanjing
Tel: 86-25-8473-2460

China - Qingdao
Tel: 86-532-8502-7355

China - Shanghai
Tel: 86-21-3326-8000

China - Shenyang
Tel: 86-24-2334-2829

China - Shenzhen
Tel: 86-755-8864-2200

China - Suzhou
Tel: 86-186-6233-1526

China - Wuhan
Tel: 86-27-5980-5300

China - Xian
Tel: 86-29-8833-7252

China - Xiamen
Tel: 86-592-2388138

China - Zhuhai
Tel: 86-756-3210040

ASIA/PACIFIC

India - Bangalore
Tel: 91-80-3090-4444

India - New Delhi
Tel: 91-11-4160-8631

India - Pune
Tel: 91-20-4121-0141

Japan - Osaka
Tel: 81-6-6152-7160

Japan - Tokyo
Tel: 81-3-6880-3770

Korea - Daegu
Tel: 82-53-744-4301

Korea - Seoul
Tel: 82-2-554-7200

Malaysia - Kuala Lumpur
Tel: 60-3-7651-7906

Malaysia - Penang
Tel: 60-4-227-8870

Philippines - Manila
Tel: 63-2-634-9065

Singapore
Tel: 65-6334-8870

Taiwan - Hsin Chu
Tel: 886-3-577-8366

Taiwan - Kaohsiung
Tel: 886-7-213-7830

Taiwan - Taipei
Tel: 886-2-2508-8600

Thailand - Bangkok
Tel: 66-2-694-1351

Vietnam - Ho Chi Minh
Tel: 84-28-5448-2100

EUROPE

Austria - Wels
Tel: 43-7242-2244-39
Fax: 43-7242-2244-393

Denmark - Copenhagen
Tel: 45-4485-5910
Fax: 45-4485-2829

Finland - Espoo
Tel: 358-9-4520-820

France - Paris
Tel: 33-1-69-53-63-20
Fax: 33-1-69-30-90-79

Germany - Garching
Tel: 49-8931-9700

Germany - Haan
Tel: 49-2129-3766400

Germany - Heilbronn
Tel: 49-7131-72400

Germany - Karlsruhe
Tel: 49-721-625370

Germany - Munich
Tel: 49-89-627-144-0
Fax: 49-89-627-144-44

Germany - Rosenheim
Tel: 49-8031-354-560

Israel - Ra'anana
Tel: 972-9-744-7705

Italy - Milan
Tel: 39-0331-742611
Fax: 39-0331-466781

Italy - Padova
Tel: 39-049-7625286

Netherlands - Drunen
Tel: 31-416-690399
Fax: 31-416-690340

Norway - Trondheim
Tel: 47-7288-4388

Poland - Warsaw
Tel: 48-22-3325737

Romania - Bucharest
Tel: 40-21-407-87-50

Spain - Madrid
Tel: 34-91-708-08-90
Fax: 34-91-708-08-91

Sweden - Gothenberg
Tel: 46-31-704-60-40

Sweden - Stockholm
Tel: 46-8-5090-4654

UK - Wokingham
Tel: 44-118-921-5800
Fax: 44-118-921-5820