

REVISION RECORD

REV	ECN	DESCRIPTION	DRFT	DATE

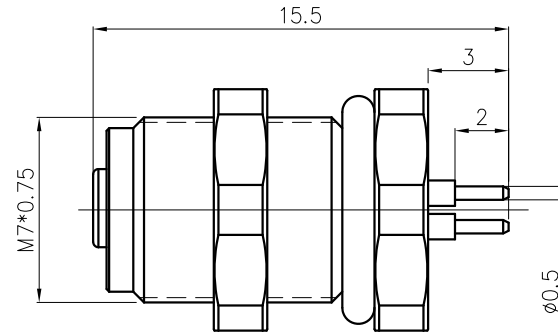
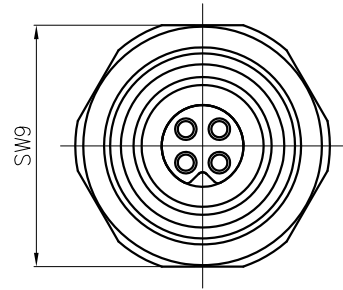

3pin A Coding

4pin A Coding

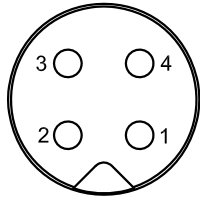
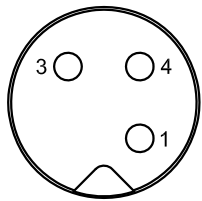

Pin Assignment Front View

Pin Assignment Front View

SP-M5A-XXP-FF-SF7002-00A(H)

Pin number: 03,04

NOTES:

1. Rated voltage/current : 60V / 1A
2. Withstanding voltage : 800V
3. Levels of protection: IP67
4. Wire connection mode: soldering(PCB)
5. Operating temperature: -40°C~+85°C
6. For Panel Thickness Range : 2.0~4.0mm
7. RoHS Compliance
8. Tolerance :
 - .X ±0.25mm
 - .XX ±0.1mm
 - Angles ±1°

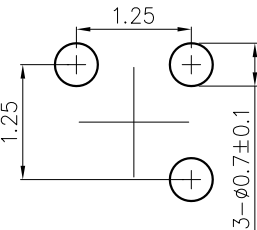

PCB layout

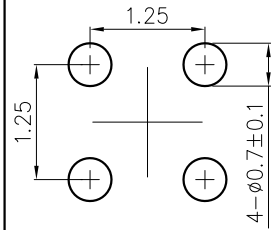

PCB layout

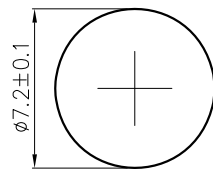

Panel cut

DETACHED LISTS	PART NO.: SPM5AXPPFFSF700200AH		宁波高松电子有限公司 NINGBO DEGSON ELECTRICAL CO., LTD	
	APPD:		NAME: SP-M5A-XXP-FF-SF7002-00A(H)	
	CHKD:		TITLE: CUSTOMER DRAWING	
	DRFT: SQ 2019.05.11		REV: D0-1	SHEET: 1/1
 THIRD ANGLE PROJECTION		DRAWING NO.: XXXXXXX-XX-CXX		SCALE: 1:1
		 MM (INCH)		DO NOT SCALE DRAWING