

REV.	DESCRIPTION	DRAWN	DATE
1	INITIAL RELEASE	FROS	2018/10/23

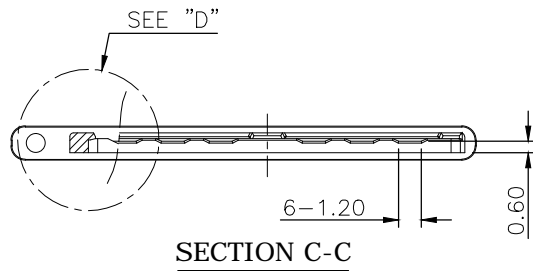

SECTION C-C

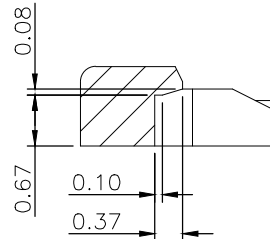

DETAIL D  
Scale 10/1

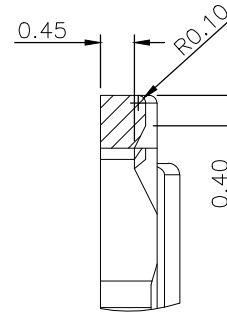

DETAIL B  
Scale 10/1

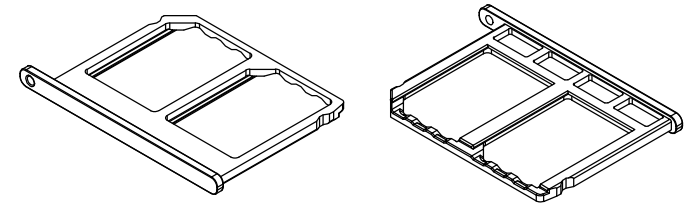

SCALE 2/1

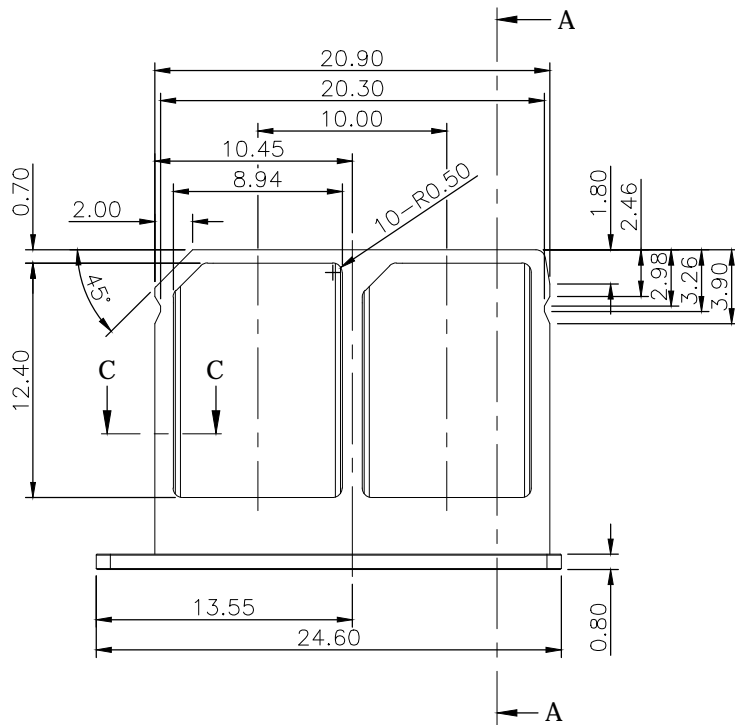

SECTION A-A

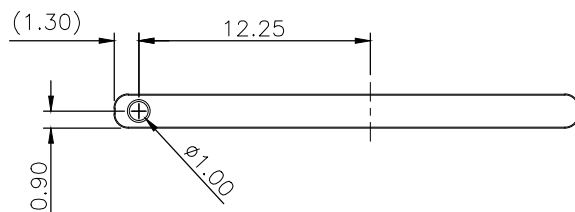
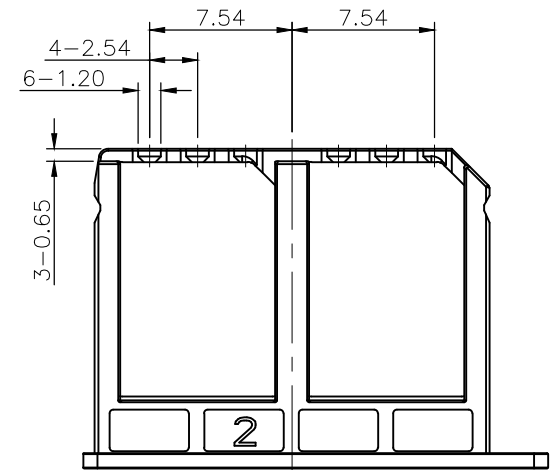

NO.	PART NAME	DESCRIPTION					
1	Tray	Stainless steel					
UNLESS OTHERWISE SPECIFIED TOLERANCE							
UNIT:	DECIMAL	LINEAR	ANGLES				
mm	X.	±0.50	±5°				
	X.X	±0.25	±3°				
	X.XX	±0.12	±1°				
www.attend.com.tw							
DRAWN	Fros	2018/10/23	DRAWN NAME:				
CHECKED	Tim	2018/10/23	Nano SIM Tray, Dual Card, SUS316 Natural color, 16.9mm, Reel				
APPROVED	Ken	2018/10/23	PRODUCT NO. 115S-BT00				
SCALE	2.5	SHEET	1/2	SIZE	A4	FILE NAME	115S-BT00_B_1

