



LA4598

Two-channel Power Amplifier for Radio Cassette Players (No Heat Sink Needed during 9 V Operation)

Overview

The LA4598 is a two-channel power IC that is intended for use in portable audio equipment. Needing no heat sink during 9 V operation facilitates set design with a small footprint.

Functions

- Thermal shutdown protector built in.
- Standby switch built in.

Features

- No heat sink needed during 9 V operation
- $P_O = 2.9 \text{ W} \times 2$ ($V_{CC} = 9 \text{ V}$, $R_L = 3.2 \Omega$, THD = 10%).
- Less quiescent current. ($V_{CC} = 9 \text{ V}$, 20 mA, typ).
- Operating voltage range: $V_{CC \text{ op}} = 4.2$ to 16 V.

Specifications

Maximum Ratings at $T_a = 25^\circ\text{C}$

Parameter	Symbol	Conditions	Ratings	Unit
Maximum supply voltage	$V_{CC \text{ max}}$		18	V
Allowable power dissipation	$P_d \text{ max}^*$	No heat sink	3.6	W
Junction temperature	$T_j \text{ max}$		+150	$^\circ\text{C}$
Operating temperature	T_{opr}		-20 to +75	$^\circ\text{C}$
Storage temperature	T_{stg}		-40 to +150	$^\circ\text{C}$

* With Sanyo-recommended board (9.0 cm \times 8.5 cm \times 1.5 mm (thickness))

Package Dimensions

unit : mm

3113A-SIP14HZ

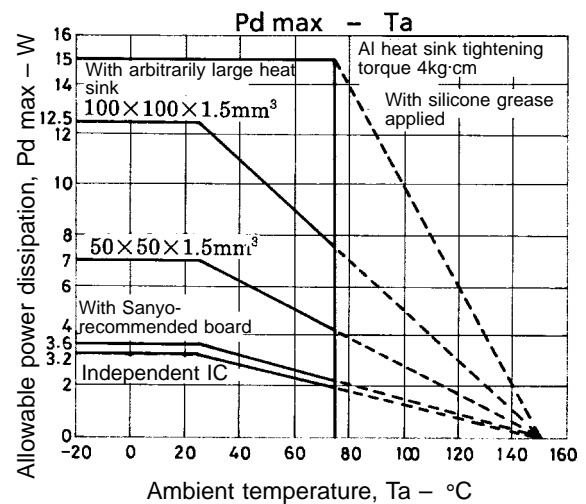
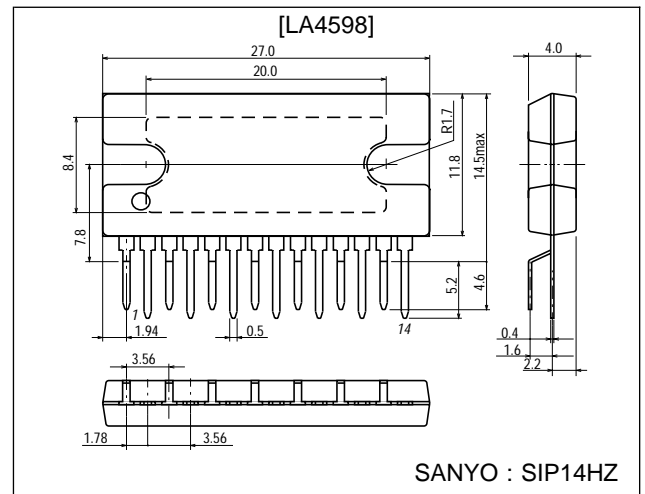

■ Any and all SANYO products described or contained herein do not have specifications that can handle applications that require extremely high levels of reliability, such as life-support systems, aircraft's control systems, or other applications whose failure can be reasonably expected to result in serious physical and/or material damage. Consult with your SANYO representative nearest you before using any SANYO products described or contained herein in such applications.

■ SANYO assumes no responsibility for equipment failures that result from using products at values that exceed, even momentarily, rated values (such as maximum ratings, operating condition ranges, or other parameters) listed in products specifications of any and all SANYO products described or contained herein.

SANYO Electric Co., Ltd. Semiconductor Company

TOKYO OFFICE Tokyo Bldg., 1-10, 1 Chome, Ueno, Taito-ku, TOKYO, 110-8534 JAPAN

D3095HA/N1792TS(II) No.4087-1/9

LA4598

Operating Conditions at $T_a = 25\text{ }^\circ\text{C}$

Parameter	Symbol	Conditions	Ratings	Unit
Recommended supply voltage	V_{CC}		9	V
Recommended load resistance	R_L		3.2	Ω
Operating voltage range	$V_{CC\text{ op}}$		4.2 to 16.0	V

Operating Characteristics at $T_a = 25\text{ }^\circ\text{C}$, $V_{CC} = 9\text{ V}$, $f = 1\text{ kHz}$, $R_g = 600\text{ }\Omega$, $R_L = 3.2\text{ }\Omega$

Parameter	Symbol	Conditions	min	typ	max	unit
Quiescent current	I_{CCO}		10	20	40	mA
Voltage gain	VG		47	49	51	dB
Output power	P_{O1}	THD = 10%	2.2	2.9		W
	P_{O2}	THD = 10%, $R_L = 4\text{ }\Omega$		2.3		W
Total harmonic distortion	THD	$V_O = 2\text{ V}$		0.3	1.0	%
Input resistance	r_i		20	30		$k\Omega$
Output noise voltage	V_{NO1}	$R_g = 0$, B.P.F = 20 Hz to 20 kHz		0.4	1.0	mV
	V_{NO2}	$R_g = 10\text{ k}\Omega$, B.P.F = 20 Hz to 20 kHz		0.6	2.0	mV
Ripple rejection ratio	Rr	$R_g = 0$, $f_r = 100\text{ Hz}$, $V_{CCr} = 150\text{ mV}$	40	50		dB
Channel separation	CH Sep	$R_g = 10\text{ k}\Omega$, $V_O = 0\text{ dB}$	45	55		dB
Standby current	I_{sd}				10	μA

Block Diagram

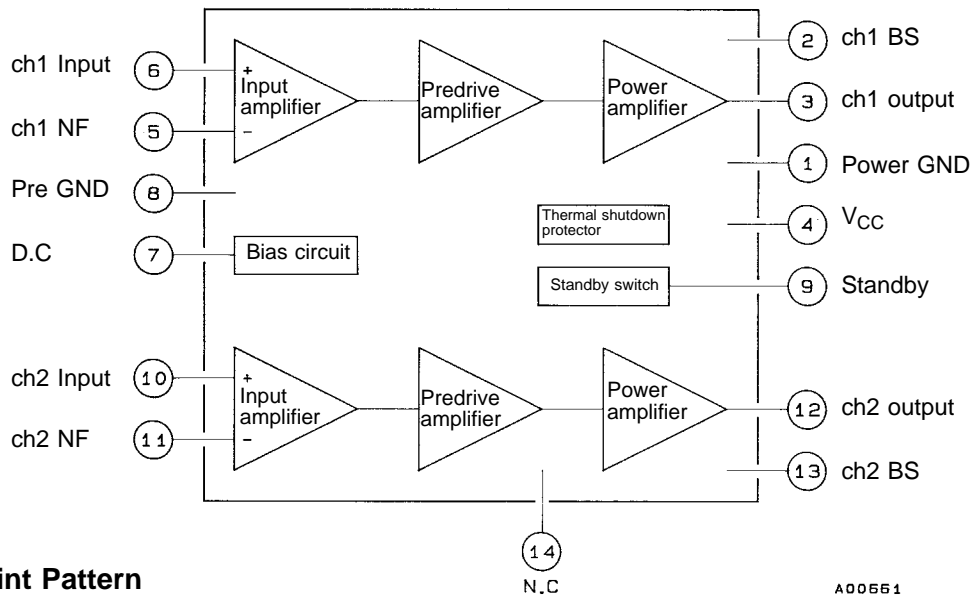

Sample Print Pattern

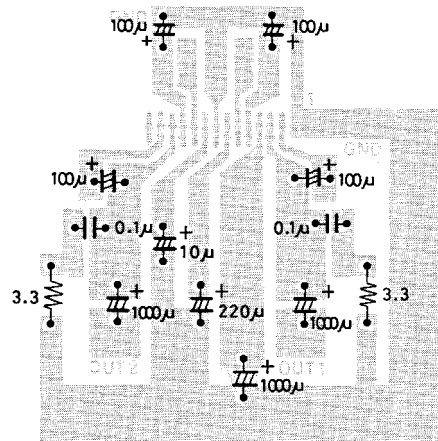

A00551

Unit (resistance: Ω , capacitance: F)

Copper-foiled side $85 \times 90\text{ mm}^2$

Sample Application Circuit

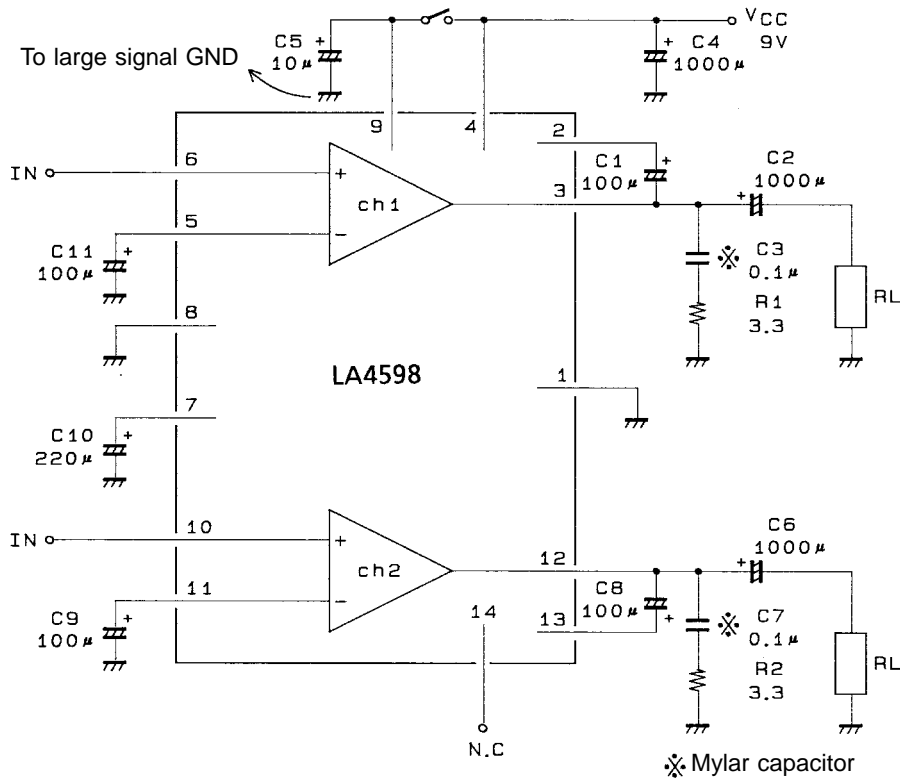

Unit (resistance:Ω, capacitance:F)

※ : Mylar capacitor

C + R can be added to the negative side of the output capacitor.

However, this is true only for a Sanyo-recommended board; for a set board, artwork must also be considered.

Description of External Components

C₁, C₈: Bootstrap capacitors

These capacitors affect low-region output; if the capacitor value is reduced, the low-region output decreases. Therefore, 47 µF or more is desirable.

C₂, C₆: Output capacitors

If the capacitor value is reduced, low-region roll-off frequency f_L and low-region P_o worsen.

C₃, C₇: Oscillation blocking capacitors

Mylar capacitor, which is excellent in temperature characteristics and frequency characteristics is used.

C₄: Power supply capacitor

The capacitor values depends on the power supply line loads (motor, and the like.) and transformer ripple component. 1000 µF to 2200 µF is recommended.

C₅: Standby capacitor

Pop noise reduction capacitor

C₉, C₁₁: Feedback capacitors

In addition to affecting low-region roll-off frequency f_L , if the capacitor value is increased, the start-up time is extended.

C₁₀: Decoupling capacitor

This capacitor absorbs power supply ripples; 220 µF is recommended.

R₁, R₂: Oscillation blocking resistors

The resistor value may be varied 3.3 Ω to 1.0 Ω.

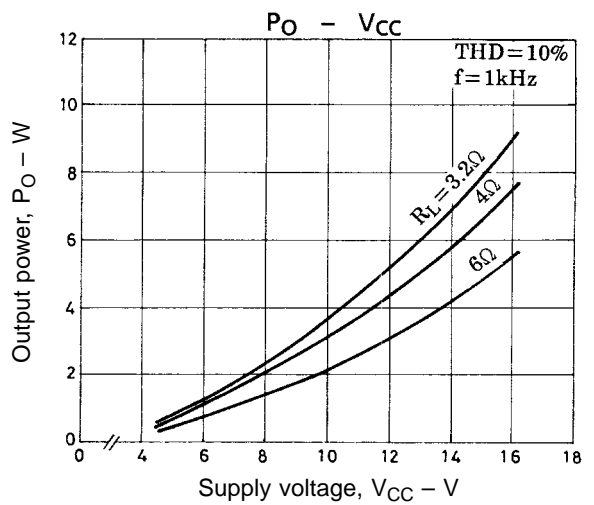
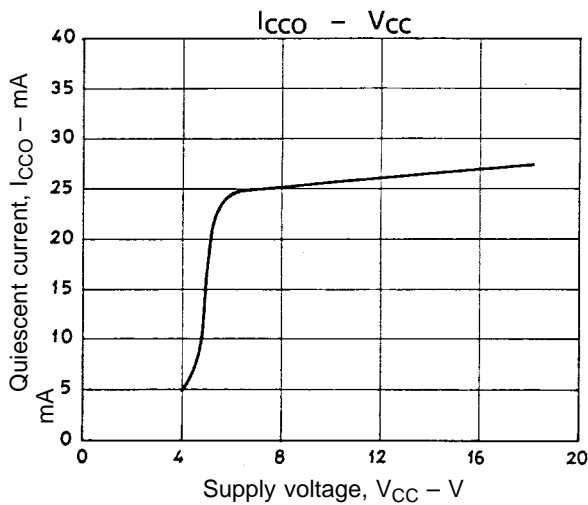
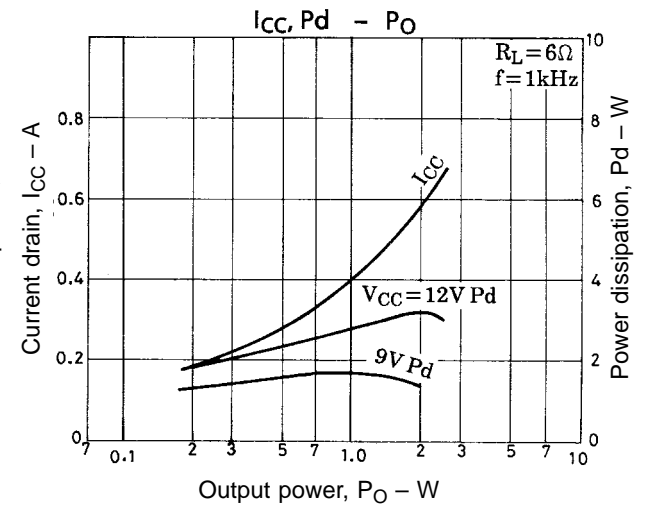
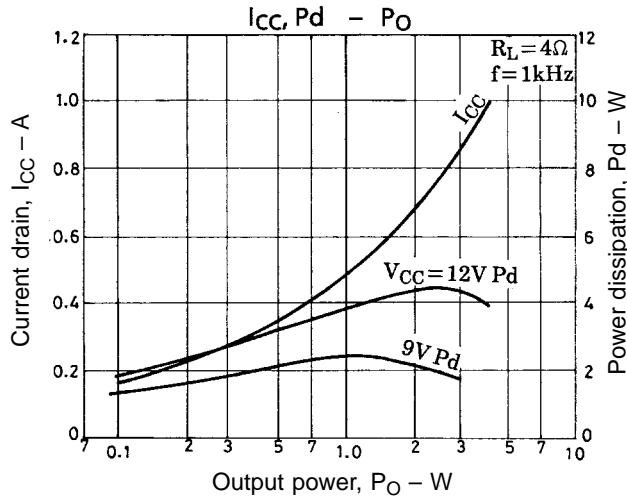
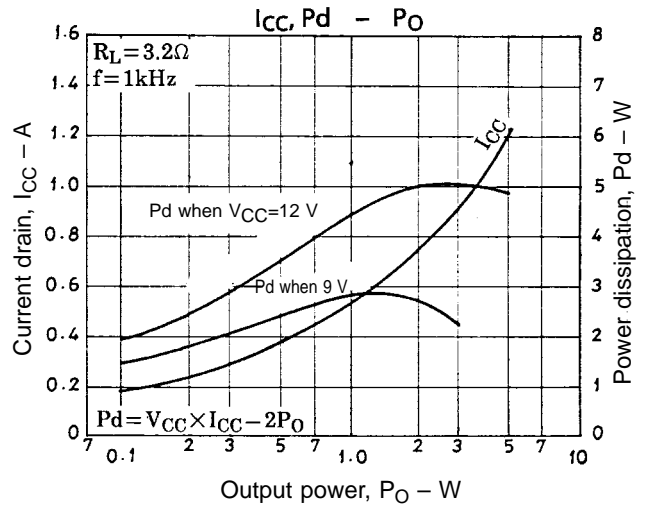
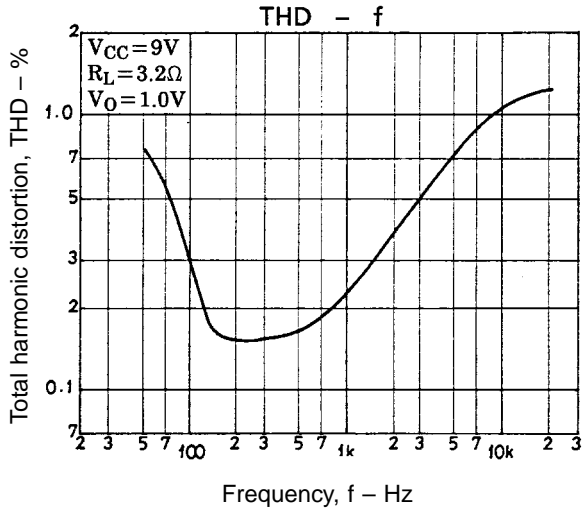

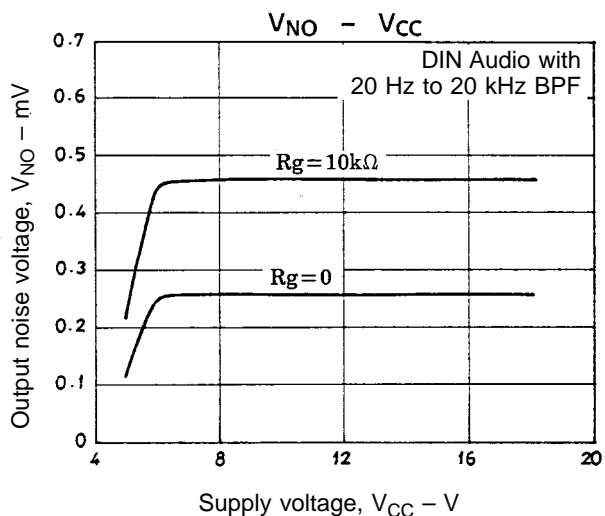
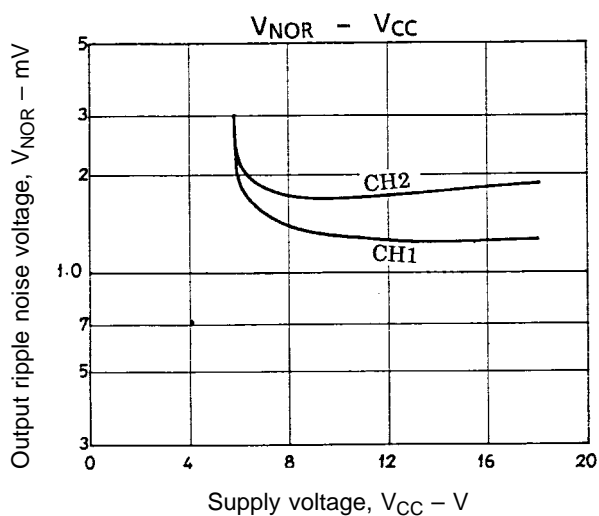
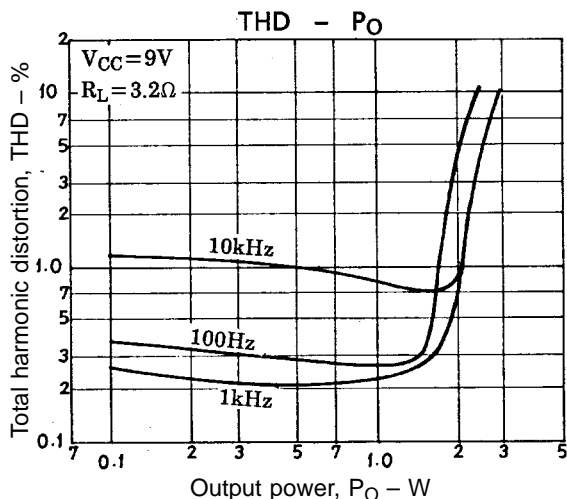
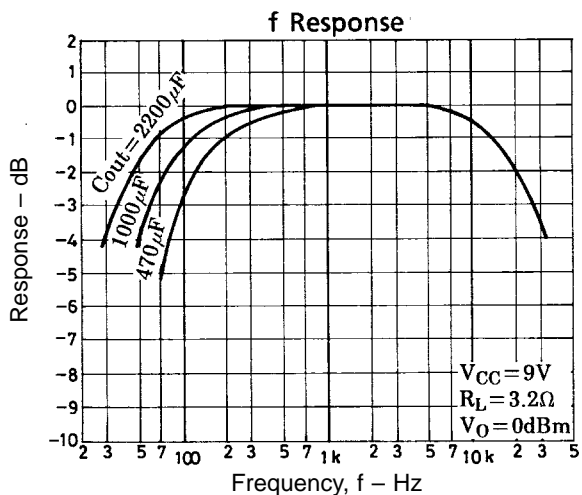
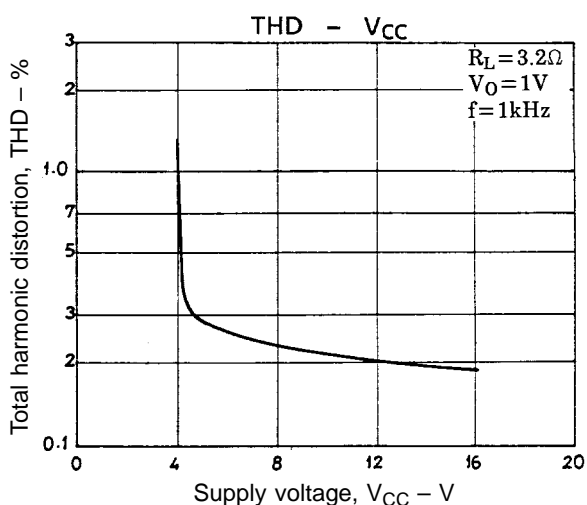
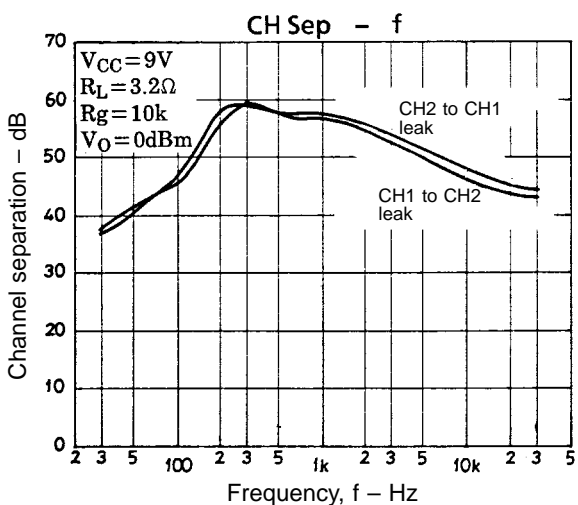

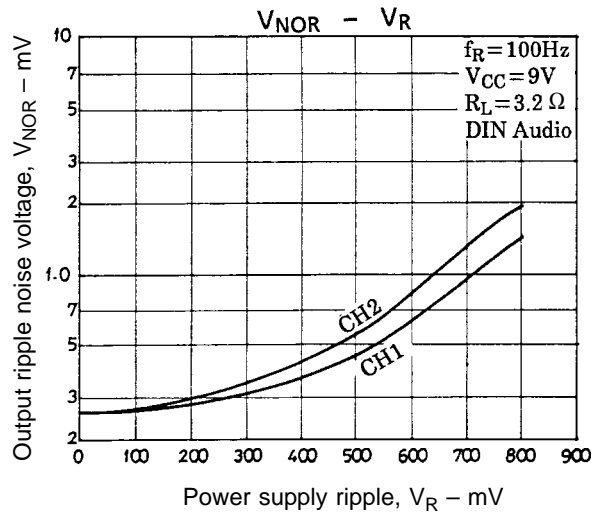
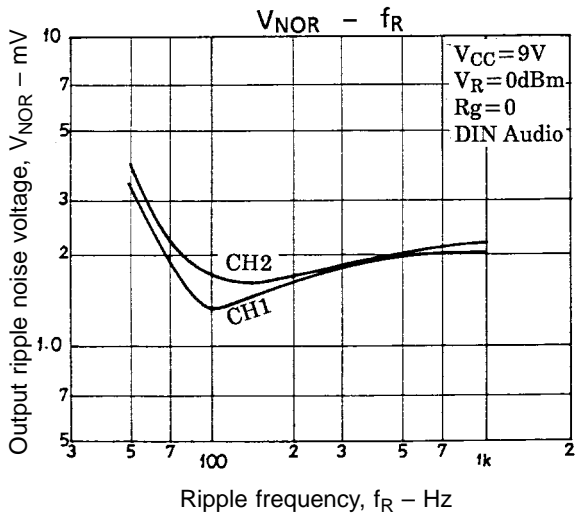

BTL Sample Application Circuit

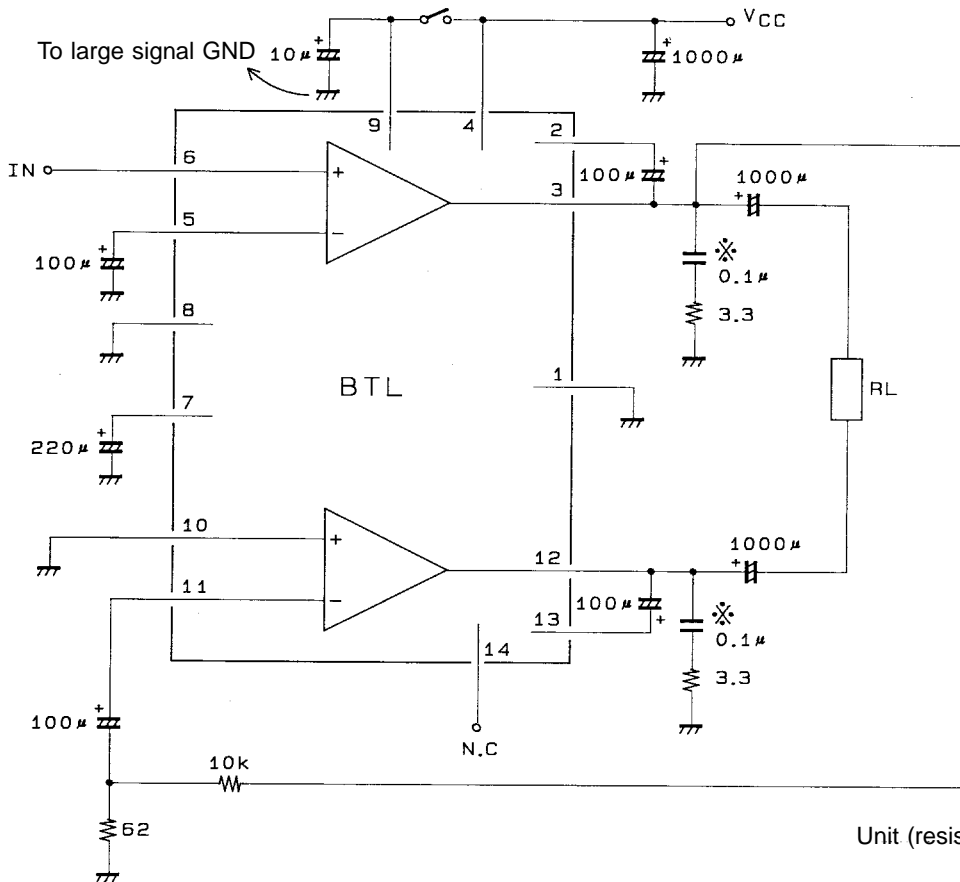

Unit (resistance: Ω , capacitance:F)

※ : Mylar capacitor

A00653

C + R can be added to the negative side of the output capacitor.

However, this is true only for a Sanyo-recommended board; for a set board, artwork must also be considered.

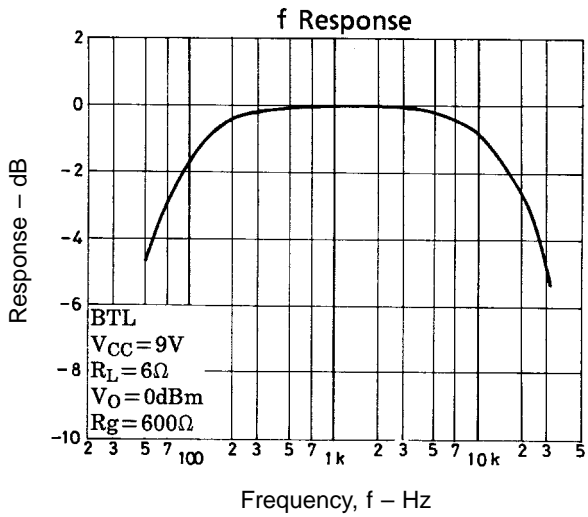
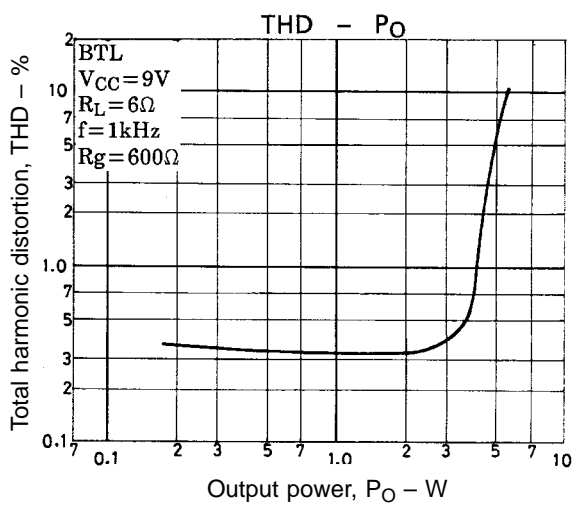
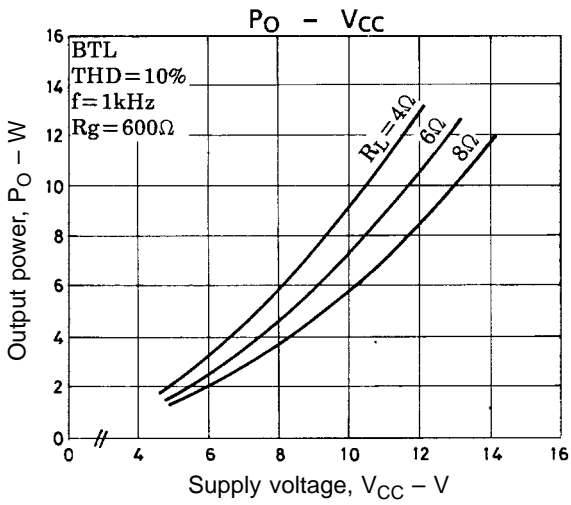
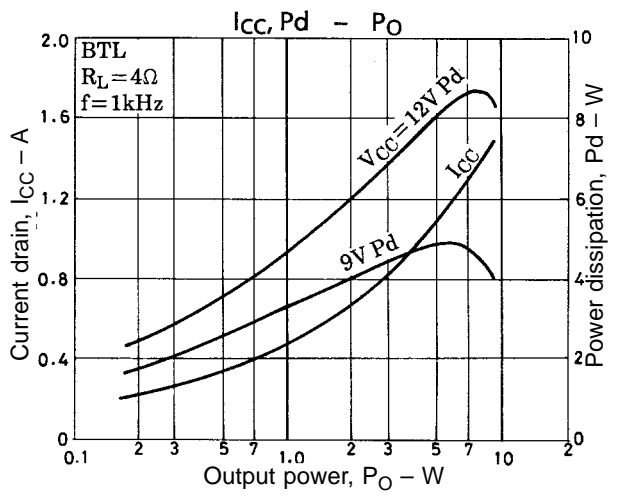
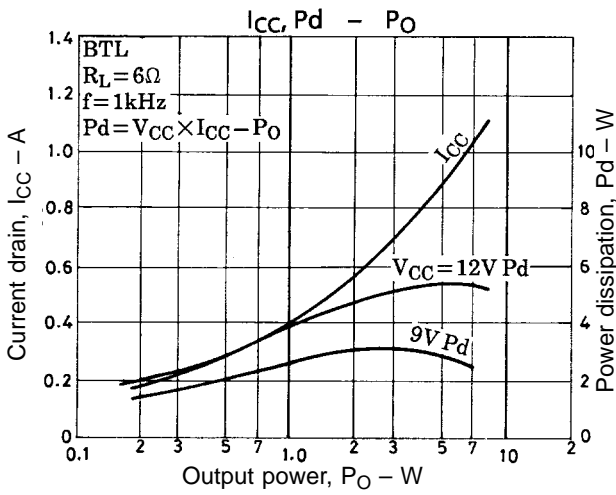

Features and Usage Notes

1. VG can be lowered by adding an R_{NF}' to the NF pins (pins 5 and 11).
Calculated as follows:
$$VG = 20 \log R_f / (R_{NF} + R_{NF}')$$
The IC contains $R_f = 20 \text{ k}\Omega$, $R_{NF} = 62 \Omega$.
However, the following must be noted:
 - a) If R_{NF}' is added, the ripple bypass effect due to the NF capacitor will worsen, resulting in a worsening of ripple rejection.
 - b) Oscillation stability requires, use at 40 dB or less to be avoided.
2. Pin 9 is intended for standby. It is used in conjunction with power supply pin 4. However, it should be noted that when power supply pin 9 and pin 4 are used for separate systems, the output power is affected by the pin 9 supply voltage.
3. It is recommendable to use no input capacitor. However when rubbing noise generated by the volume control is offensive to the ear, an input capacitor must be inserted.
4. Extreme caution must be exercised when the IC is used in the vicinity of the maximum ratings, since even a slight variation in conditions may cause the maximum ratings to be exceeded, thereby leading to breakdown.
5. When making the board, refer to the sample printed circuit pattern. No feedback loop must be formed between input and output. Thick and short wiring is required so that no common resistance exists between the preamplifier GND and power amplifier GND.
6. Addition of components as shown below enables use without introducing an increased distortion at V_{CC} of up to approximately 4.5 V. A capacitor of 470 μF is inserted against pop noise.

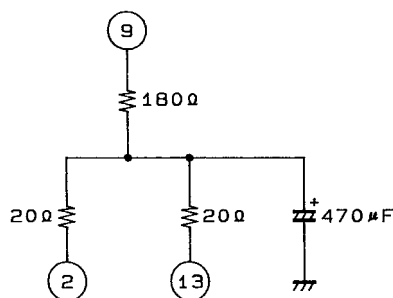

A04680

Proper Cares in Mounting a Radiator Fin

1. The tightening torque should be in a range from 4 to 6 kg.cm.
2. The spacing between the screw holes of the radiator fin must match the spacing between the screw holes of the IC. With case outline dimensions L and R referred to, the screws must be tightened with the distance between them as close to each other as possible.

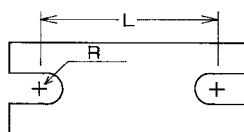

A00665

3. The screws to be used must have a head equivalent to the one of truss machine screw or binder machine screw defined by JIS. Washers must also be used to protect the IC case.
4. No foreign matter such as cutting particles should exist between heat sink and radiator fin. When applying grease on the junction surface, it must be applied uniformly on the whole surface.
5. IC lead pins should be soldered to the printed circuit board after the radiator fin is mounted on the IC.

- Specifications of any and all SANYO products described or contained herein stipulate the performance, characteristics, and functions of the described products in the independent state, and are not guarantees of the performance, characteristics, and functions of the described products as mounted in the customer's products or equipment. To verify symptoms and states that cannot be evaluated in an independent device, the customer should always evaluate and test devices mounted in the customer's products or equipment.
- SANYO Electric Co., Ltd. strives to supply high-quality high-reliability products. However, any and all semiconductor products fail with some probability. It is possible that these probabilistic failures could give rise to accidents or events that could endanger human lives, that could give rise to smoke or fire, or that could cause damage to other property. When designing equipment, adopt safety measures so that these kinds of accidents or events cannot occur. Such measures include but are not limited to protective circuits and error prevention circuits for safe design, redundant design, and structural design.
- In the event that any or all SANYO products(including technical data, services) described or contained herein are controlled under any of applicable local export control laws and regulations, such products must not be exported without obtaining the export license from the authorities concerned in accordance with the above law.
- No part of this publication may be reproduced or transmitted in any form or by any means, electronic or mechanical, including photocopying and recording, or any information storage or retrieval system, or otherwise, without the prior written permission of SANYO Electric Co., Ltd.
- Any and all information described or contained herein are subject to change without notice due to product/technology improvement, etc. When designing equipment, refer to the "Delivery Specification" for the SANYO product that you intend to use.
- Information (including circuit diagrams and circuit parameters) herein is for example only ; it is not guaranteed for volume production. SANYO believes information herein is accurate and reliable, but no guarantees are made or implied regarding its use or any infringements of intellectual property rights or other rights of third parties.

This catalog provides information as of December, 1995. Specifications and information herein are subject to change without notice.