

MOC3061M, MOC3062M, MOC3063M, MOC3162M, MOC3163M 6-Pin DIP Zero-Cross Phototriac Driver Optocoupler (600 Volt Peak)

Features

- Simplifies logic control of 115/240 VAC power
- Zero voltage crossing
- dv/dt of 1000V/ μ s guaranteed (MOC316X-M),
– 600V/ μ s guaranteed (MOC306X-M)
- VDE recognized (File # 94766)
– ordering option V (e.g., MOC3063V-M)
- Underwriters Laboratories (UL) recognized
(File #E90700, volume 2)

Applications

- Solenoid/valve controls
- Static power switches
- Temperature controls
- AC motor starters
- Lighting controls
- AC motor drives
- E.M. contactors
- Solid state relays

Description

The MOC306XM and MOC316XM devices consist of a GaAs infrared emitting diode optically coupled to a monolithic silicon detector performing the function of a zero voltage crossing bilateral triac driver. They are designed for use with a triac in the interface of logic systems to equipment powered from 115/240 VAC lines, such as solid-state relays, industrial controls, motors, solenoids and consumer appliances, etc.

Schematic



Package Outlines

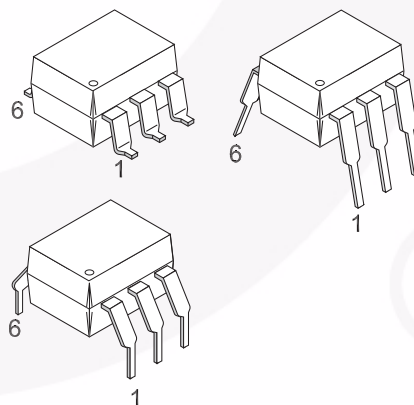

Absolute Maximum Ratings ($T_A = 25^\circ\text{C}$ unless otherwise noted)

Stresses exceeding the absolute maximum ratings may damage the device. The device may not function or be operable above the recommended operating conditions and stressing the parts to these levels is not recommended. In addition, extended exposure to stresses above the recommended operating conditions may affect device reliability. The absolute maximum ratings are stress ratings only.

Symbol	Parameters	Device	Value	Units
TOTAL DEVICE				
T_{STG}	Storage Temperature	All	-40 to +150	$^\circ\text{C}$
T_{OPR}	Operating Temperature	All	-40 to +85	$^\circ\text{C}$
T_{SOL}	Lead Solder Temperature	All	260 for 10 sec	$^\circ\text{C}$
T_J	Junction Temperature Range	All	-40 to +100	$^\circ\text{C}$
V_{ISO}	Isolation Surge Voltage ⁽¹⁾ (peak AC voltage, 60Hz, 1 sec. duration)	All	7500	Vac(pk)
P_D	Total Device Power Dissipation @ 25 $^\circ\text{C}$ Ambient Derate above 25 $^\circ\text{C}$	All	250	mW
			2.94	mW/ $^\circ\text{C}$
EMITTER				
I_F	Continuous Forward Current	All	60	mA
V_R	Reverse Voltage	All	6	V
P_D	Total Power Dissipation @ 25 $^\circ\text{C}$ Ambient Derate above 25 $^\circ\text{C}$	All	120	mW
			1.41	mW/ $^\circ\text{C}$
DETECTOR				
V_{DRM}	Off-State Output Terminal Voltage	All	600	V
I_{TSM}	Peak Repetitive Surge Current (PW = 100 μs , 120pps)	All	1	A
P_D	Total Power Dissipation @ 25 $^\circ\text{C}$ Ambient Derate above 25 $^\circ\text{C}$	All	150	mW
			1.76	mW/ $^\circ\text{C}$

Note:

1. Isolation surge voltage, V_{ISO} , is an internal device dielectric breakdown rating. For this test, Pins 1 and 2 are common, and Pins 4, 5 and 6 are common.

Electrical Characteristics ($T_A = 25^\circ\text{C}$ Unless otherwise specified)**Individual Component Characteristics**

Symbol	Parameters	Test Conditions	Device	Min.	Typ.*	Max.	Units
EMITTER							
V_F	Input Forward Voltage	$I_F = 30\text{mA}$	All		1.3	1.5	V
I_R	Reverse Leakage Current	$V_R = 6\text{V}$	All		0.005	100	μA
DETECTOR							
I_{DRM1}	Peak Blocking Current, Either Direction	$V_{\text{DRM}} = 600\text{V}$, $I_F = 0^{(2)}$	MOC316XM		10	100	nA
			MOC306XM		10	500	
dv/dt	Critical Rate of Rise of Off-State Voltage	$I_F = 0$ (Figure 9) ⁽³⁾	MOC306XM	600	1500		V/ μs
			MOC316XM	1000			

Transfer Characteristics

Symbol	DC Characteristics	Test Conditions	Device	Min.	Typ.*	Max.	Units
I_{FT}	LED Trigger Current (rated I_{FT})	Main Terminal Voltage = $3\text{V}^{(3)}$	MOC3061M			15	mA
			MOC3062M/ MOC3162M			10	
			MOC3063M/ MOC3163M			5	
V_{TM}	Peak On-State Voltage, Either Direction	$I_{\text{TM}} = 100\text{mA}$ peak, $I_F = \text{rated } I_{\text{FT}}$	All		1.8	3	V
I_{H}	Holding Current, Either Direction		All		500		μA

Zero Crossing Characteristics

Symbol	Characteristics	Test Conditions	Device	Min.	Typ.*	Max.	Units
V_{INH}	Inhibit Voltage (MT1-MT2 voltage above which device will not trigger)	$I_F = \text{Rated } I_{\text{FT}}$	MOC3061M/2M/3M		12	20	V
			MOC3162M/3M		12	15	
I_{DRM2}	Leakage in Inhibited State	$I_F = \text{Rated } I_{\text{FT}}$, $V_{\text{DRM}} = 600\text{V}$, off state	All			2	mA

Isolation Characteristics

Symbol	Characteristics	Test Conditions	Device	Min.	Typ.*	Max.	Units
V_{ISO}	Isolation Voltage	$f = 60\text{Hz}$, $t = 1\text{sec}$	All	7500			V

*Typical values at $T_A = 25^\circ\text{C}$ **Notes:**

- Test voltage must be applied within dv/dt rating.
- All devices are guaranteed to trigger at an I_F value less than or equal to max I_{FT} . Therefore, recommended operating I_F lies between max I_{FT} (15mA for MOC3061M, 10mA for MOC3062M & MOC3162M, 5mA for MOC3063M & MOC3163M) and absolute max I_F (60mA).
- This is static dv/dt. See Figure 9 for test circuit. Commutating dv/dt is a function of the load-driving thyristor(s) only.

Safety and Insulation Ratings

As per IEC 60747-5-2, this optocoupler is suitable for “safe electrical insulation” only within the safety limit data. Compliance with the safety ratings shall be ensured by means of protective circuits.

Symbol	Parameter	Min.	Typ.	Max.	Unit
	Installation Classifications per DIN VDE 0110/1.89 Table 1				
	For Rated Main Voltage < 150Vrms		I-IV		
	For Rated Main voltage < 300Vrms		I-IV		
	Climatic Classification		55/100/21		
	Pollution Degree (DIN VDE 0110/1.89)		2		
CTI	Comparative Tracking Index	175			
V_{PR}	Input to Output Test Voltage, Method b, $V_{IORM} \times 1.875 = V_{PR}$, 100% Production Test with $t_m = 1$ sec, Partial Discharge < 5pC	1594			V_{peak}
	Input to Output Test Voltage, Method a, $V_{IORM} \times 1.5 = V_{PR}$, Type and Sample Test with $t_m = 60$ sec, Partial Discharge < 5pC	1275			V_{peak}
V_{IORM}	Max. Working Insulation Voltage	850			V_{peak}
V_{IOTM}	Highest Allowable Over Voltage	6000			V_{peak}
	External Creepage	7			mm
	External Clearance	7			mm
	Insulation Thickness	0.5			mm
RIO	Insulation Resistance at T_s , $V_{IO} = 500V$	10^9			Ω

Typical Performance Curves

Figure 1. LED Forward Voltage vs. Forward Current

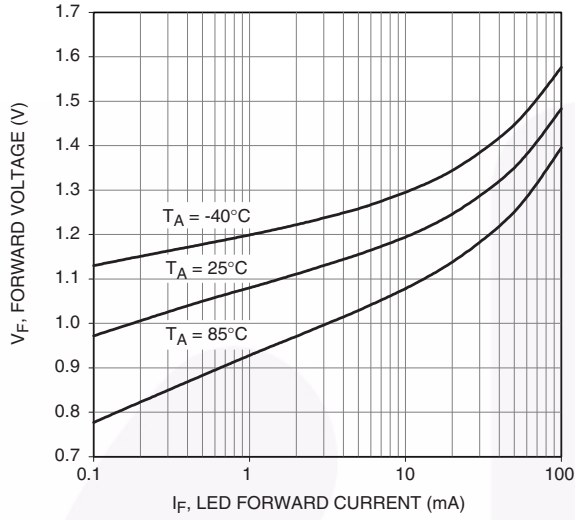

Figure 2. Trigger Current Vs. Temperature

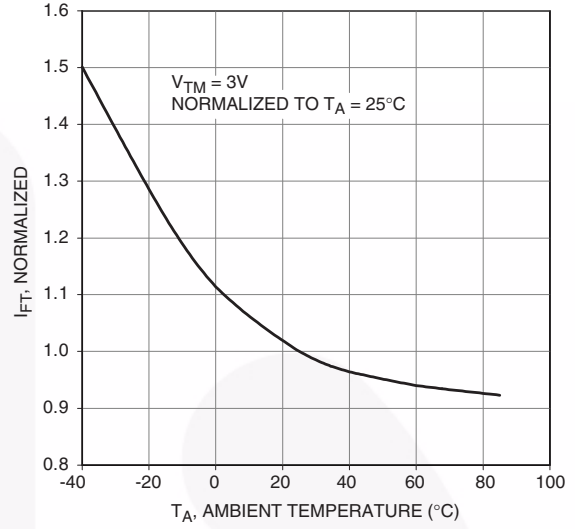

Figure 3. LED Current Required to Trigger vs. LED Pulse Width

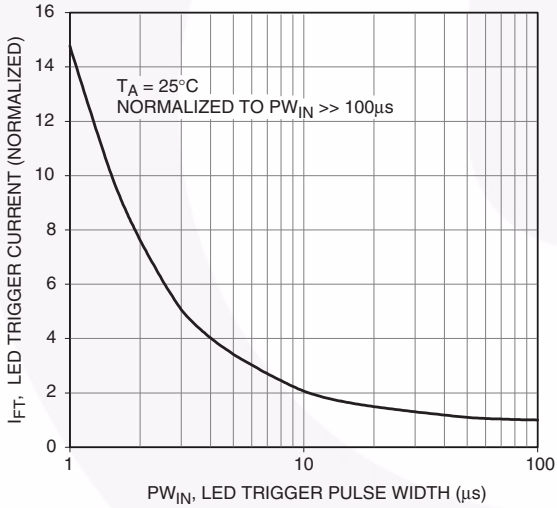
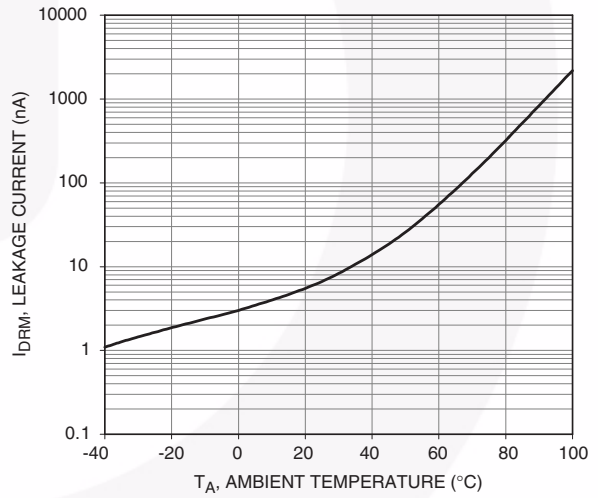

Figure 4. Leakage Current, I_{DRM} vs. Temperature



Typical Performance Curves (Continued)

Figure 5. I_{DRM2} , Leakage in Inhibit State vs. Temperature



Figure 6. On-State Characteristics

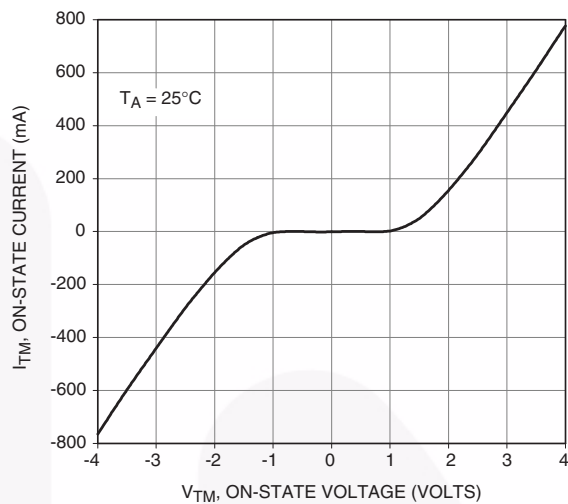

Figure 7. I_H , Holding Current vs. Temperature

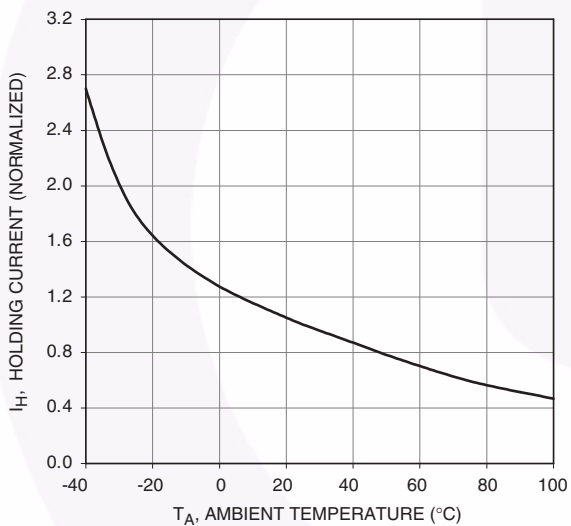
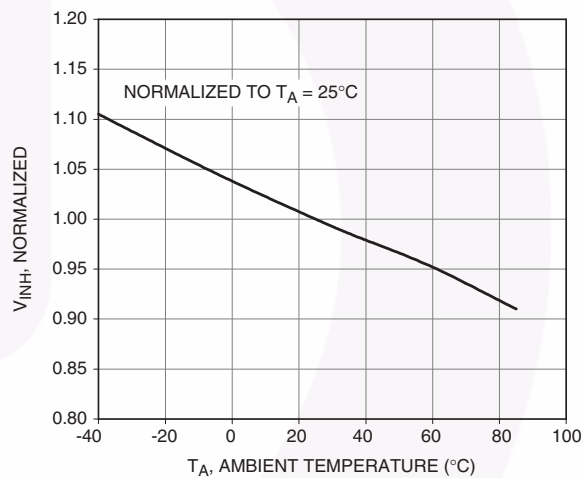
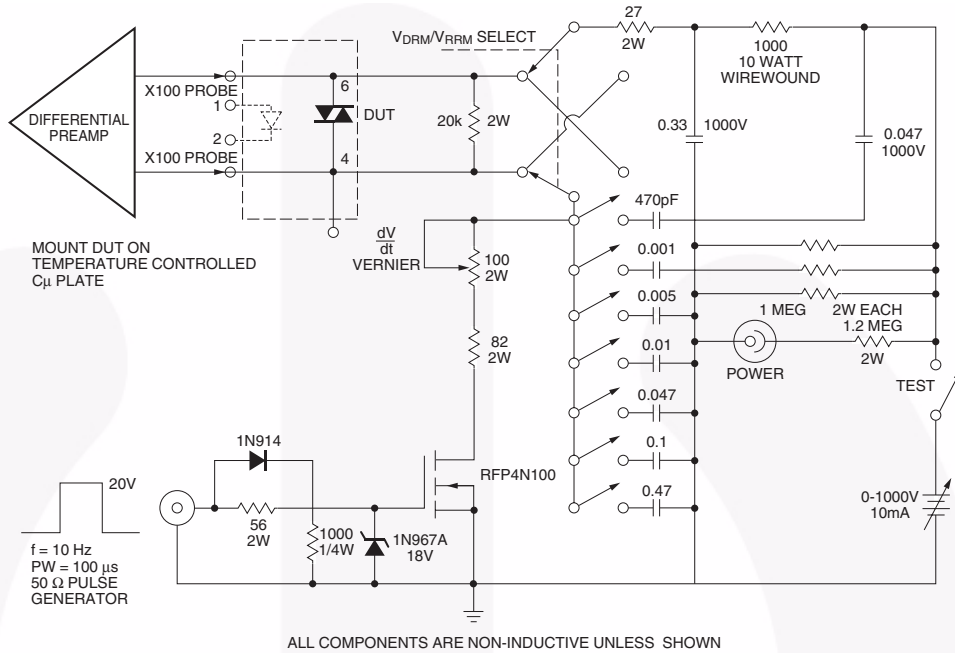

Figure 8. Inhibit Voltage vs. Temperature



1. 100x scope probes are used, to allow high speeds and voltages.
2. The worst-case condition for static dv/dt is established by triggering the D.U.T. with a normal LED input current, then removing the current. The variable vernier resistor combined with various capacitor combinations allows the dv/dt to be gradually increased until the D.U.T. continues to trigger in response to the applied voltage pulse, even after the LED current has been removed. The dv/dt is then decreased until the D.U.T. stops triggering. t_{RC} is measured at this point and recorded.



ALL COMPONENTS ARE NON-INDUCTIVE UNLESS SHOWN

Figure 9. Circuit for Static $\frac{dv}{dt}$ Measurement of Power Thyristors

Basic Applications

Typical circuit for use when hot line switching is required. In this circuit the “hot” side of the line is switched and the load connected to the cold or neutral side. The load may be connected to either the neutral or hot line.

R_{in} is calculated so that I_F is equal to the rated I_{FT} of the part, 15mA for the MOC3061M, 10mA for the MOC3062M, or 5mA for the MOC3063M. The 39Ω resistor and 0.01μF capacitor are for snubbing of the triac and is often, but not always, necessary depending upon the particular triac and load used.

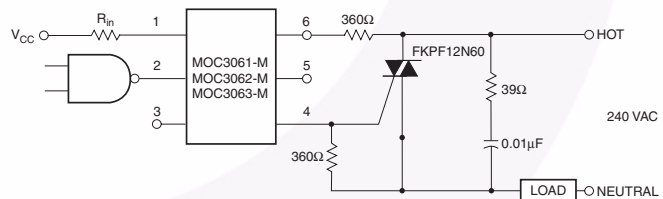

Figure 10. Hot-Line Switching Application Circuit

Suggested method of firing two, back-to-back SCR's with a Fairchild triac driver. Diodes can be 1N4001; resistors, R1 and R2, are optional 330Ω.

Note:

This optoisolator should not be used to drive a load directly. It is intended to be a trigger device only.

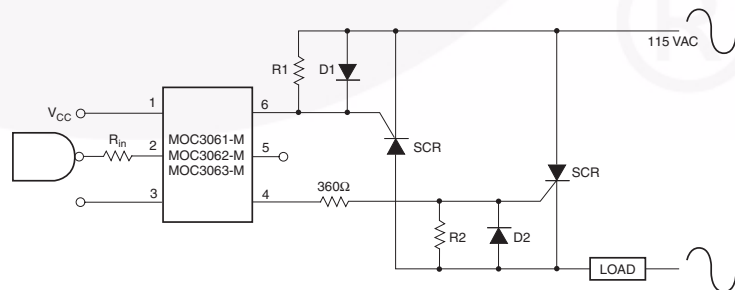

Figure 11. Inverse-Parallel SCR Driver Circuit

Package Dimensions

Through Hole



0.4" Lead Spacing



Surface Mount



Recommended Pad Layout

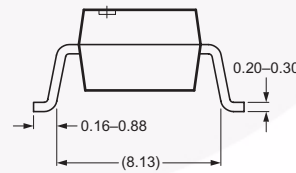

Note:
All dimensions in mm.

Ordering Information

Option	Order Entry Identifier (Example)	Description
No option	MOC3061M	Standard Through Hole Device
S	MOC3061SM	Surface Mount Lead Bend
SR2	MOC3061SR2M	Surface Mount; Tape and Reel
T	MOC3061TM	0.4" Lead Spacing
V	MOC3061VM	VDE 0884
TV	MOC3061TVM	VDE 0884, 0.4" Lead Spacing
SV	MOC3061SVM	VDE 0884, Surface Mount
SR2V	MOC3061SR2VM	VDE 0884, Surface Mount, Tape and Reel

Marking Information



Definitions	
1	Fairchild logo
2	Device number
3	VDE mark (Note: Only appears on parts ordered with VDE option – See order entry table)
4	One digit year code, e.g., '3'
5	Two digit work week ranging from '01' to '53'
6	Assembly package code

*Note – Parts that do not have the 'V' option (see definition 3 above) that are marked with date code '325' or earlier are marked in portrait format.

Carrier Tape Specification







Reflow Profile





TRADEMARKS

The following includes registered and unregistered trademarks and service marks, owned by Fairchild Semiconductor and/or its global subsidiaries, and is not intended to be an exhaustive list of all such trademarks.

- | | | | |
|--|--|---|--|
| AccuPower™ | F-PFS™ | Power-SPM™ |  SYSTEM GENERAL®* |
| Auto-SPM™ | FRFET® | PowerTrench® | The Power Franchise® |
| Build it Now™ | Global Power Resource™ | PowerXS™ | the power franchise |
| CorePLUS™ | Green FPS™ | Programmable Active Droop™ | TinyBoost™ |
| CorePOWER™ | Green FPS™ e-Series™ | QFET® | TinyBuck™ |
| CROSSVOLT™ | Gmax™ | QS™ | TinyCalc™ |
| CTL™ | GTO™ | Quiet Series™ | TinyLogic® |
| Current Transfer Logic™ | IntelliMAX™ | RapidConfigure™ | TINYOPTO™ |
| DEUXPEED® | ISOPLANAR™ |  SignalWise™ | TinyPower™ |
| Dual Cool™ | MegaBuck™ | Saving our world, 1mW/W/kW at a time™ | TinyPWM™ |
| EcoSPARK® | MICROCOUPLER™ | SmartMax™ | TinyWire™ |
| EfficientMax™ | MicroFET™ | SMART START™ | TriFault Detect™ |
| ESBC™ | MicroPak™ | SPM® | TRUECURRENT™* |
|  Fairchild® | MicroPak2™ | STEALTH™ | "SerDes™ |
| Fairchild Semiconductor® | MillerDrive™ | SuperFET™ |  SerDes™ |
| FACT Quiet Series™ | MotionMax™ | SuperSOT™-3 | UHC® |
| FACT® | Motion-SPM™ | SuperSOT™-6 | Ultra FRFET™ |
| FAST® | OptoHiT™ | SuperSOT™-8 | UniFET™ |
| FastvCore™ | OPTOLOGIC® | SupreMOS® | VCX™ |
| FETBench™ | OPTOPLANAR® | SyncFET™ | VisualMax™ |
| FlashWriter®* |  PDP SPM™ | Sync-Lock™ | XS™ |
| FPS™ | | | |

* Trademarks of System General Corporation, used under license by Fairchild Semiconductor.

DISCLAIMER

FAIRCHILD SEMICONDUCTOR RESERVES THE RIGHT TO MAKE CHANGES WITHOUT FURTHER NOTICE TO ANY PRODUCTS HEREIN TO IMPROVE RELIABILITY, FUNCTION, OR DESIGN. FAIRCHILD DOES NOT ASSUME ANY LIABILITY ARISING OUT OF THE APPLICATION OR USE OF ANY PRODUCT OR CIRCUIT DESCRIBED HEREIN; NEITHER DOES IT CONVEY ANY LICENSE UNDER ITS PATENT RIGHTS, NOR THE RIGHTS OF OTHERS. THESE SPECIFICATIONS DO NOT EXPAND THE TERMS OF FAIRCHILD'S WORLDWIDE TERMS AND CONDITIONS, SPECIFICALLY THE WARRANTY THEREIN, WHICH COVERS THESE PRODUCTS.

LIFE SUPPORT POLICY

FAIRCHILD'S PRODUCTS ARE NOT AUTHORIZED FOR USE AS CRITICAL COMPONENTS IN LIFE SUPPORT DEVICES OR SYSTEMS WITHOUT THE EXPRESS WRITTEN APPROVAL OF FAIRCHILD SEMICONDUCTOR CORPORATION.

As used herein:

1. Life support devices or systems are devices or systems which, (a) are intended for surgical implant into the body or (b) support or sustain life, and (c) whose failure to perform when properly used in accordance with instructions for use provided in the labeling, can be reasonably expected to result in a significant injury of the user.
2. A critical component in any component of a life support, device, or system whose failure to perform can be reasonably expected to cause the failure of the life support device or system, or to affect its safety or effectiveness.

ANTI-COUNTERFEITING POLICY

Fairchild Semiconductor Corporation's Anti-Counterfeiting Policy. Fairchild's Anti-Counterfeiting Policy is also stated on our external website, www.fairchildsemi.com, under Sales Support.

Counterfeiting of semiconductor parts is a growing problem in the industry. All manufacturers of semiconductor products are experiencing counterfeiting of their parts. Customers who inadvertently purchase counterfeit parts experience many problems such as loss of brand reputation, substandard performance, failed applications, and increased cost of production and manufacturing delays. Fairchild is taking strong measures to protect ourselves and our customers from the proliferation of counterfeit parts. Fairchild strongly encourages customers to purchase Fairchild parts either directly from Fairchild or from Authorized Fairchild Distributors who are listed by country on our web page cited above. Products customers buy either from Fairchild directly or from Authorized Fairchild Distributors are genuine parts, have full traceability, meet Fairchild's quality standards for handling and storage and provide access to Fairchild's full range of up-to-date technical and product information. Fairchild and our Authorized Distributors will stand behind all warranties and will appropriately address any warranty issues that may arise. Fairchild will not provide any warranty coverage or other assistance for parts bought from Unauthorized Sources. Fairchild is committed to combat this global problem and encourage our customers to do their part in stopping this practice by buying direct or from authorized distributors.

PRODUCT STATUS DEFINITIONS

Definition of Terms

Datasheet Identification	Product Status	Definition
Advance Information	Formative / In Design	Datasheet contains the design specifications for product development. Specifications may change in any manner without notice.
Preliminary	First Production	Datasheet contains preliminary data; supplementary data will be published at a later date. Fairchild Semiconductor reserves the right to make changes at any time without notice to improve design.
No Identification Needed	Full Production	Datasheet contains final specifications. Fairchild Semiconductor reserves the right to make changes at any time without notice to improve the design.
Obsolete	Not In Production	Datasheet contains specifications on a product that is discontinued by Fairchild Semiconductor. The datasheet is for reference information only.

Rev. I49