

HF118F

MINIATURE HIGH POWER RELAY



File No.: E134517



File No.: 40010480



File No.: CQC09002035071

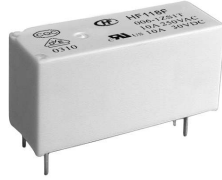

Features

- 10A switching capability
- 5kV dielectric strength (between coil and contacts)
- Low height: 12.5 mm
- Creepage distance >8mm
- Meeting VDE 0700, 0631 reinforce insulation
- Product in accordance to IEC 60335-1 available
- UL insulation system: Class F
- Sockets available
- Plastic sealed and flux proofed types available
- Environmental friendly product (RoHS compliant)
- Outline Dimensions: 28.5mm x 10.1mm x 12.5mm

CONTACT DATA

Contact arrangement	1A, 1B, 1C
Contact material	See ordering info.
Contact resistance ¹⁾	100mΩ max.(at 1A 6VDC)
Contact rating (Res. load)	10A 250VAC/30VDC
Max. switching voltage	440VAC / 125VDC
Max. switching current	10A
Max. switching power	2500VA / 300W
Mechanical endurance	1 x 10 ⁷ OPS
Electrical endurance	1H type: 1 x 10 ⁵ OPS (8A 250VAC, Resistive load, AgNi, at 85°C, 5s on 5s off)

Notes: 1) The data shown above are initial values.

CHARACTERISTICS

Insulation resistance	1000MΩ (at 500VDC)	
Dielectric strength	Between coil & contacts	5000VAC 1min
	Between open contacts	1000VAC 1min
Surge voltage (between coil & contacts)	10kV (1.2 / 50μs)	
Operate time (at nomi. vot.)	10ms max.	
Release time (at nomi. vot.)	5ms max.	
Temperature rise (at nomi. Volt.)	55K max.	
Shock resistance *	Functional	NC: 49m/s ² NO: 98m/s ²
	Destructive	980m/s ²
Vibration resistance *	NC (no coil voltage)	10Hz to 55Hz 0.8mm DA
	NO	10Hz to 55Hz 1.65mm DA
Ambient temperature	-40°C to 85°C	
Humidity	5% to 85% RH	
Termination	PCB	
Unit weight	Approx. 8g	
Construction	Plastic sealed, Flux proofed	

Notes: 1) The data shown above are initial values.

2) * Index is not in relay length direction.

COIL

Coil power	Approx. 220mW to 290mW
------------	------------------------

COIL DATA

at 23°C

Nominal Voltage VDC	Pick-up Voltage VDC max. ¹⁾	Drop-out Voltage VDC min. ¹⁾	Max. Voltage VDC ²⁾	Coil Resistance Ω
5	3.50	0.5	7.5	113 x (1±10%)
6	4.20	0.6	9.0	164 x (1±10%)
9	6.30	0.9	13.5	360 x (1±10%)
12	8.40	1.2	18.0	620 x (1±10%)
18	12.60	1.8	27.0	1295 x (1±10%)
24	16.80	2.4	36.0	2350 x (1±15%)
48 ³⁾	33.60	4.8	72.0	8000 x (1±15%)
60 ³⁾	42.00	6.0	90.0	12500 x (1±15%)

Notes: 1) The data shown above are initial values.

2) Maximum voltage refers to the maximum voltage which relay coil could endure in a short period of time.

3) For products with rated voltage ≥ 48V, measures should be taken to prevent coil overvoltage in order to protect coil in test and application (eg. Connect diodes in parallel).



HONGFA RELAY

ISO9001, ISO/TS16949, ISO14001, OHSAS18001, IECQ QC 080000 CERTIFIED

2018 Rev. 1.10

SAFETY APPROVAL RATINGS

UL/CUL (AgNi, AgSnO ₂)	version 1,3,5,6	10A 250VAC at 85°C
		10A 30VDC at 85°C
VDE (AgNi, AgNi+Au)	1H (;S) (1;3;5) (-;G)	B300 at 85°C
	1D (;S) (1;3;6) (-;G)	R300 at 85°C
	1Z (-;S) (1;3) (-;G)	1/2HP 240VAC at 85°C
VDE (AgSnO ₂ , AgSnO ₂ +Au)		AgSnO ₂ : 1/3HP 120VAC at 85°C
	1H (-;S) (1;3;5), T.(-;G)	8A 250VAC at 85°C
	1D (-;S) (1;3;6), T.(-;G)	8A 250VAC at 85°C
	1Z (-;S) (1;3), T.(-;G)	8A 250VAC at 85°C
	1H (-;S) (1;3;5), T.(-;G)	AC-15 (Make: 30A 250VAC COS Ø=0.7 at 85°C Break: 3A 250VAC COS Ø=0.4 at 85°C)
	1Z (-;S) (1;3), T.(-;G)	NO: AC-15 (Make: 30A 250VAC COS Ø=0.7 at 85°C Break: 3A 250VAC COS Ø=0.4 at 85°C)

Notes: 1) All values unspecified are at room temperature.

2) Only typical loads are listed above. Other load specifications can be available upon request.

ORDERING INFORMATION

Type	HF118F / 012 -1H S 1 G (XXX)
Coil voltage	5, 6, 9, 12, 18, 24, 48, 60VDC
Contact arrangement	1H: 1 Form A 1D: 1 Form B 1Z: 1 Form C
Construction ¹⁾²⁾	S: Plastic sealed Nil: Flux proofed
Version (See Wiring Diagram below)	1: 3.2mm 1 pole 8A 3: 3.2mm 1 pole 10A, double pinning 5: 5mm 8A, only 1 Form A 6: 5mm 8A, only 1 Form B
Contact material ³⁾	T: AgSnO ₂ G: AgNi+Au plated TG: AgSnO ₂ +Au plated Nil: AgNi
Special code ⁴⁾	XXX: Customer special requirement Nil: Standard

Notes: 1) We recommend flux proofed types for a clean environment (free from contaminations like H₂S, SO₂, NO₂, dust, etc.).

We suggest to choose plastic sealed types and validate it in real application for an unclean environment (with contaminations like H₂S, SO₂, NO₂, dust, etc.).

2) Contact is recommended for suitable condition and specifications if water cleaning or surface process is involved in assembling relays on PCB.

3) For gold plated type, the min. switching current and min. switching voltage is 10mA 5VDC.

4) The customer special requirement express as special code after evaluating by Hongfa. e.g.(335) stands for product in accordance to IEC 60335-1 (GWT). e.g.(253) stands for Reflow soldering version.

OUTLINE DIMENSIONS, WIRING DIAGRAM AND PC BOARD LAYOUT

Unit: mm

Outline Dimensions

3.2mm pinning

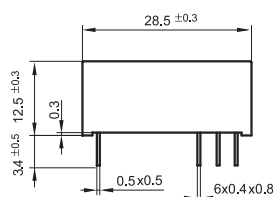

5mm pinning

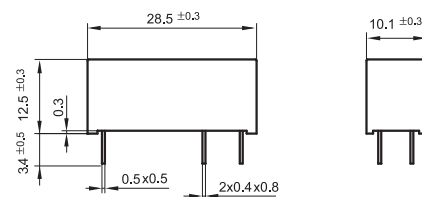

OUTLINE DIMENSIONS, WIRING DIAGRAM AND PC BOARD LAYOUT

Unit: mm

Wiring Diagram (Bottom view)

Version 1



Version 3

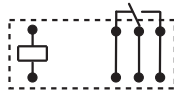

Version 5



Version 6



PCB Layout (Bottom view)

Version 1

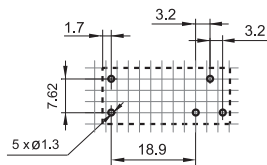

Version 3

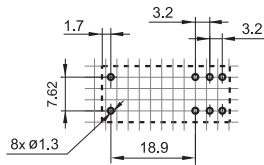

Version 5/6

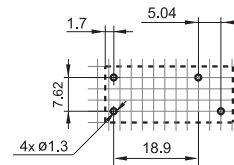

- Remark: 1) In case of no tolerance shown in outline dimension: outline dimension ≤ 1 mm, tolerance should be ± 0.2 mm; outline dimension > 1 mm and ≤ 5 mm, tolerance should be ± 0.3 mm; outline dimension > 5 mm, tolerance should be ± 0.4 mm.
 2) The tolerance without indicating for PCB layout is always ± 0.1 mm.
 3) The width of the gridding is 2.54mm.

CHARACTERISTIC CURVES

MAXIMUM SWITCHING POWER

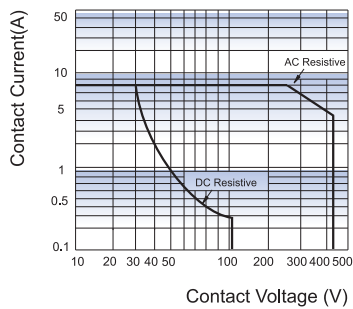

ENDURANCE CURVE

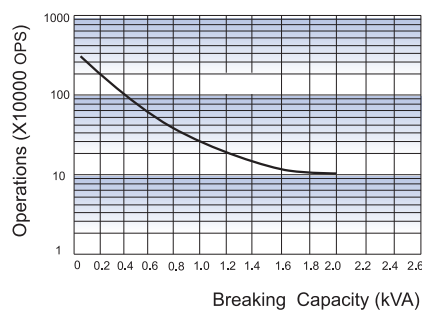

REFLOW WELDING TEMPERATURE
(Reflow soldering version)

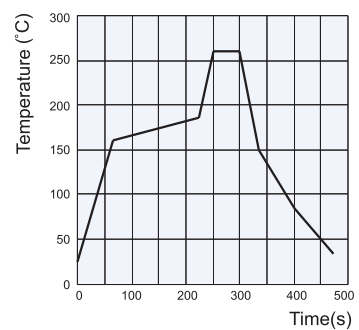

Notes:

- 1) Curve: 1Z1 type
- 2) Test conditions:
 NO, Resistive load, 250VAC
 Flux proofed, Room temp., 1s on 9s off.

Relay Sockets



Features

- The dielectric strength can reach 5000VAC and the insulation resistance is 1000MΩ
- Two mounting types are available: PCB and screw mounting.
- Environmental friendly product (RoHS compliant)

CHARACTERISTICS

Type	Nominal Voltage	Nominal Current	Ambient Temperature	Dielectric Strength min.	Unit weight
118F-1Z-A1-1	250VAC	10A	-40 °C to 70°C	5000VAC	Approx.3g
118F-2Z-A1	250VAC	10A	-40 °C to 70°C	5000VAC	Approx.3g

OUTLINE DIMENSIONS, WIRING DIAGRAM AND PC BOARD LAYOUT

Unit: mm

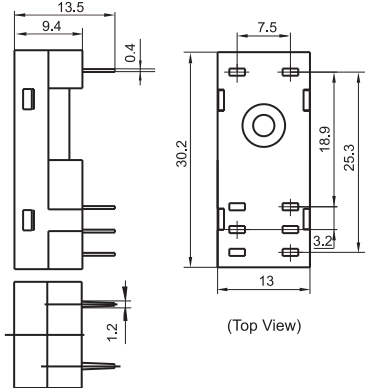
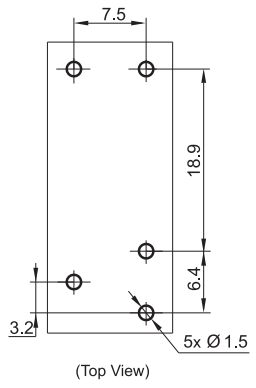
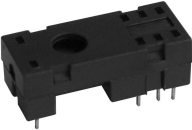
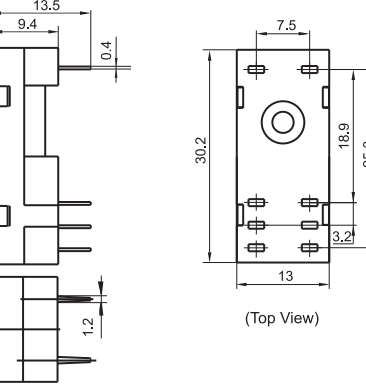
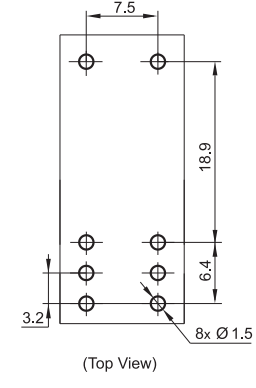
Socket	Outline Dimensions	Wiring Diagram	Components Available
<p>118F-1Z-A1-1</p>  <p>PCB terminal, PCB or Screw mounting Applicable for HF118F/XXX-1XX1XX</p>	 <p>(Top View)</p>	 <p>(Top View)</p>	<p>metallic retainer 118F-H1</p>
<p>118F-2Z-A1</p>  <p>PCB terminal, PCB or Screw mounting Applicable for HF118F/XXX-1XX3XX</p>	 <p>(Top View)</p>	 <p>(Top View)</p>	<p>metallic retainer 118F-H1</p>

Retainer

118F-H1 (Metallic retainer)

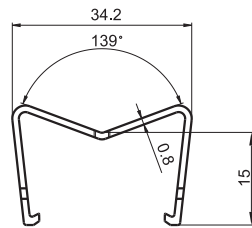

Things to be noticed when selecting sockets:

1. Please choose suitable relay socket according to the actual mounting environment, relay contact poles and terminal layout. If there is any query on selection, please contact Hongfa for the technical service.
2. As for related components, they should be selected separately. Please do give clear indication of the types of relay sockets and related components you choose while placing order.
3. The above is only an example of typical socket and related component type which is suitable to HF118F 1 poles relay. If you have any special requirements, please contact us.
4. Main outline dimension(L, W, H) ≥ 50 mm, tolerance should be ± 1 mm; outline dimension > 20 mm and < 50 mm, tolerance should be ± 0.5 mm; outline dimension ≤ 20 mm, tolerance should be ± 0.3 mm.

Disclaimer

The specification is for reference only. See to "Terminology and Guidelines" for more information. Specifications subject to change without notice.. We could not evaluate all the performance and all the parameters for every possible application. Thus the user should be in a right position to choose the suitable product for their own application. If there is any query, please contact Hongfa for the technical service. However, it is the user's responsibility to determine which product should be used only.

© Xiamen Hongfa Electroacoustic Co., Ltd. All rights of Hongfa are reserved.