

Headers(Sockets) for pluggable terminal blocks / ECH & EHD series

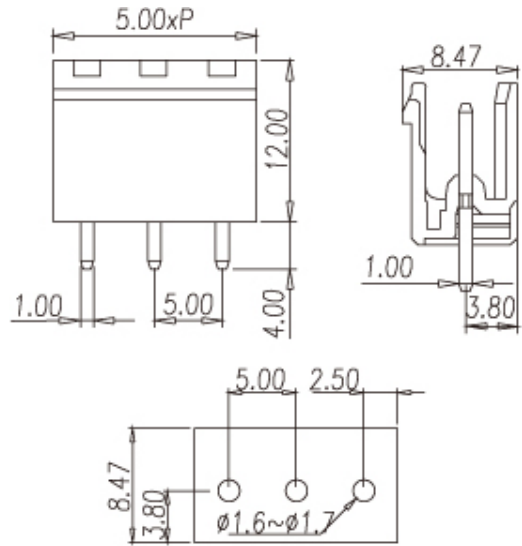

5EHDV

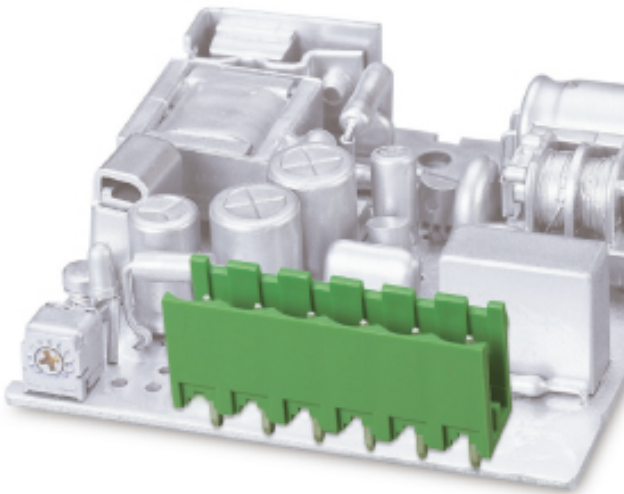

Pitch: 5.00mm

Approval		
Technical Data	UL	IEC
Rated voltage	300V	250V
Rated current	15A	17.5A
Wire range		
Solid wire (AWG)		
Stranded wire (AWG/mm ²)		
Rated surge voltage (UL/IEC/Max.)	1.6 / 2 / 4 KV	
Torque (Lb-in)		
Screw		
Wire strip length		
Pole	Cat. No.	
02	5EHDV-02P	
:	:	
:	:	
24	5EHDV-24P	

TEL: +886-2-2908-0614

FAX: +886-2-2908-8549

E-mail: infor@dinkle.com.tw