

DC/DC Converter

E_S-1WR3 & F_S-1WR3 Series

MORNSUN®

1W isolated DC-DC converter

Fixed input voltage, unregulated dual/single output

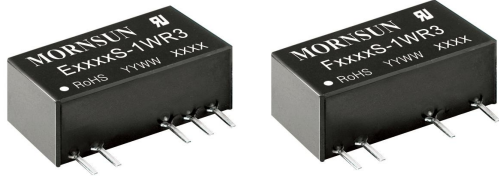

Continuous Short Circuit Protection



3 years Warranty

RoHS Patent Protection



UL 62368-1



EN 62368-1



BS EN 62368-1



IEC 62368-1

FEATURES

- Continuous short-circuit protection
- No-load input current as low as 8mA
- Operating ambient temperature range: -40°C to +105°C
- High efficiency up to 85%
- I/O isolation test voltage: 3k VDC
- Industry standard pin-out

E_S-1WR3 & F_S-1WR3 series are specially designed for applications where an isolated (two isolated) voltage is required in a distributed power supply system. They are suitable for: pure digital circuits, low frequency analog circuits, relay-driven circuits and data switching circuits.

Selection Guide						
Certification	Part No.	Input Voltage (VDC)	Output		Full Load Efficiency (%) Min./Typ.	Capacitive Load(μF) Max.*
		Nominal (Range)	Voltage (VDC)	Current (mA) Max./Min.		
--	E0303S-1WR3	3.3 (2.97-3.63)	±3.3	±150/±15	74/78	1200
	E0305S-1WR3		±5	±100/±10	78/82	1200
	E0309S-1WR3		±9	±56/±6	81/85	470
	E0312S-1WR3		±12	±42/±5	78/82	220
	E0315S-1WR3		±15	±34/±4	78/82	220
	E0324S-1WR3		±24	±21/±2	80/84	100
	F0303S-1WR3		3.3	303/30	75/79	2400
	F0305S-1WR3		5	200/20	78/82	2400
	F0309S-1WR3		9	111/11	81/85	1000
	F0312S-1WR3		12	83/8	78/82	560
	F0315S-1WR3		15	67/7	78/82	560
	F0324S-1WR3		24	42/4	80/84	220
	EN/BS EN		E0503S-1WR3	5 (4.5-5.5)	±3.3	±152/±15
UL/EN/BS EN/IEC	E0505S-1WR3	±5	±100/±10		78/82	1200
	E0509S-1WR3	±9	±56/±6		79/83	470
	E0512S-1WR3	±12	±42/±5		79/83	220
	E0515S-1WR3	±15	±34/±4		79/83	220
	E0524S-1WR3	±24	±21/±3		81/85	100
	F0503S-1WR3	3.3	303/30		70/74	2400
	F0505S-1WR3	5	200/20		78/82	2400
	F0509S-1WR3	9	111/12		79/83	1000
	F0512S-1WR3	12	84/9		79/83	560
	F0515S-1WR3	15	67/7		79/83	560
	F0524S-1WR3	24	42/4		81/85	220
	--	F0909S-1WR3	9 (8.1-9.9)		9	111/12

MORNSUN®

MORNSUN Guangzhou Science & Technology Co., Ltd.

UL/EN/BS EN/IEC	E1203S-1WR3	12 (10.8-13.2)	±3.3	±152/±15	71/75	1200	
	E1205S-1WR3		±5	±100/±10	76/80	1200	
--	E1209S-1WR3		±9	±56/±5	76/80	470	
UL/EN/BS EN/IEC	E1212S-1WR3		±12	±42/±5	77/81	220	
	E1215S-1WR3		±15	±34/±4	77/81	220	
	E1224S-1WR3		±24	±21/±2	76/80	100	
	F1203S-1WR3		3.3	303/30	71/75	2400	
	F1205S-1WR3		5	200/20	76/80	2400	
	F1209S-1WR3		9	111/12	76/80	1000	
	F1212S-1WR3		12	83/9	76/80	560	
	F1215S-1WR3		15	67/7	77/81	560	
--	F1224S-1WR3		24	42/5	77/81	220	
	E1505S-1WR3	15 (13.5-16.5)	±5	±100/±10	76/80	1200	
--	E1509S-1WR3		±9	±56/±5	76/80	470	
UL/EN/BS EN/IEC	E1512S-1WR3		±12	±42/±5	76/80	220	
	E1515S-1WR3		±15	±34/±4	77/81	220	
--	E1524S-1WR3		±24	±21/±2	77/81	100	
UL/EN/BS EN/IEC	F1505S-1WR3		5	200/20	76/80	2400	
	F1509S-1WR3		9	111/12	76/80	1000	
	F1512S-1WR3		12	83/9	76/80	560	
	F1515S-1WR3		15	67/7	77/81	560	
--	F1524S-1WR3		24	42/5	77/81	220	
--	E2403S-1WR3		24 (21.6-26.4)	±3.3	±150/±15	72/76	1200
UL/EN/BS EN/IEC	E2405S-1WR3			±5	±100/±10	74/80	1200
--	E2409S-1WR3	±9		±56/±5	74/80	470	
UL/EN/BS EN/IEC	E2412S-1WR3	±12		±42/±5	75/81	220	
	E2415S-1WR3	±15		±34/±4	73/79	220	
	E2424S-1WR3	±24		±21/±2	74/80	100	
UL/EN/BS EN/IEC	F2403S-1WR3	3.3		303/30	69/75	2400	
	F2405S-1WR3	5		200/20	73/79	2400	
--	F2407S-1WR3	7.2		139/13	74/80	1000	
UL/EN/BS EN/IEC	F2409S-1WR3	9		111/12	74/80	1000	
	F2412S-1WR3	12		83/9	75/81	560	
	F2415S-1WR3	15		67/7	75/81	560	
UL/EN/BS EN/IEC	F2424S-1WR3	24	42/5	75/81	220		

Note: *The specified maximum capacitive load for positive and negative output is identical.

Input Specifications

Item	Operating Conditions		Min.	Typ.	Max.	Unit
Input Current (full load / no-load)	3.3VDC input	3.3VDC output	--	384/10	405/--	mA
		other output	--	370/18	389/--	
	5VDC input	3.3VDC/5VDC output	--	270/8	286/--	
		9VDC/12VDC output	--	241/12	254/--	
		15VDC/24VDC output	--	241/18	254/--	
	9V input		--	137/8	144/--	
	12V input	3.3VDC output	--	112/8	118/--	
		5VDC/9VDC output	--	105/8	110/--	
		12VDC/15VDC output	--	103/8	109/--	

Input Current (full load / no-load)	12V input	24VDC output	--	105/8	110/--	mA
	15V input	5VDC/9VDC/12VDC output	--	84/8	88/--	
		15VDC/24VDC output	--	83/8	87/--	
	24V input	3.3VDC output	--	55/8	58/--	
		5VDC/9VDC/24VDC output	--	53/8	57/--	
		12VDC output	--	53/8	56/--	
		15VDC output	--	53/8	58/--	
Reflected Ripple Current*			--	15	--	
Surge Voltage(1sec. max.)	3.3VDC input		-0.7	--	5	VDC
	5VDC input		-0.7	--	9	
	9VDC input		-0.7	--	12	
	12VDC input		-0.7	--	18	
	15VDC input		-0.7	--	21	
	24VDC input		-0.7	--	30	
Input Filter				Capacitance filter		
Hot Plug				Unavailable		

Note: * Refer to DC-DC Converter Application Notes for detailed description of reflected ripple current test method.

Output Specifications

Item	Operating Conditions		Min.	Typ.	Max.	Unit
Voltage Accuracy			See output regulation curves (Fig. 1)			
Linear Regulation	Input voltage change: $\pm 1\%$	3.3VDC output	--	--	1.5	--
		Other output	--	--	1.2	
Load Regulation	3.3VDC input 10% -100% load	3.3VDC output	--	12	18	%
		Other output	--	8	15	
	5VDC input 10% -100% load	3.3VDC output	--	15	20	
		5VDC output	--	10	15	
		9VDC output	--	8	10	
		12VDC output	--	7	10	
		15VDC output	--	6	10	
		24VDC output	--	5	10	
	9/12/15/24VDC input 10%-100% load	3.3VDC output	--	15	20	
		5VDC output	--	10	15	
Other output		--	8	10		
Ripple & Noise*	20MHz bandwidth	24VDC output	--	50	100	mVp-p
		Other output	--	30	75	
Temperature Coefficient	Full load		--	± 0.02	--	$\%/^{\circ}\text{C}$
Short-Circuit Protection			Continuous, self-recovery			

Note: * The "parallel cable" method is used for Ripple and Noise test, please refer to DC-DC Converter Application Notes for specific information.

General Specifications

Item	Operating Conditions	Min.	Typ.	Max.	Unit
Isolation	Input-output electric strength test for 1 minute with a leakage current of 1mA max.	3000	--	--	VDC
Insulation Resistance	Input-output resistance at 500VDC	1000	--	--	M Ω
Isolation Capacitance	Input-output capacitance at 100kHz/0.1V	--	20	--	pF

Operating Temperature	5VDC input	Derating when operating temperature $\geq 85^{\circ}\text{C}$, (see Fig. 2)	-40	--	105	$^{\circ}\text{C}$
Operating Temperature	Other input	Derating when operating temperature $\geq 100^{\circ}\text{C}$, (see Fig. 2)	-40	--	105	$^{\circ}\text{C}$
Storage Temperature			-55	--	125	
Case Temperature Rise	Ta=25 $^{\circ}\text{C}$		--	25	--	
Pin Soldering Resistance Temperature	Soldering spot is 1.5mm away from case for 10 seconds		--	--	300	
Storage Humidity	Non-condensing	3.3/5VDC input	--	--	95	%RH
		Other input	5	--	95	
Vibration	9/12/15/24VDC input		10-150Hz, 5G, 0.75mm. along X, Y and Z			
Switching Frequency	Full load, nominal input voltage	3.3VDC input	--	220	--	kHz
		5VDC input	--	270	--	
		9/12/15/24VDC input	--	260	--	
MTBF	MIL-HDBK-217F@25 $^{\circ}\text{C}$		3500	--	--	k hours

Mechanical Specifications

Case Material	Black plastic; flame-retardant and heat-resistant (UL94V-0)
Dimensions	19.65 x 6.00 x 10.16mm
Weight	2.1g(Typ.)
Cooling Method	Free air convection

Electromagnetic Compatibility (EMC)

Emissions	CE	CISPR32/EN55032	CLASS B
	RE	CISPR32/EN55032	CLASS B
Immunity	ESD	IEC/EN61000-4-2	Air $\pm 8\text{kV}$, Contact $\pm 6\text{kV}$ perf. Criteria B

Note: Refer to Fig. 4 for recommended circuit test.

Typical Performance Curves

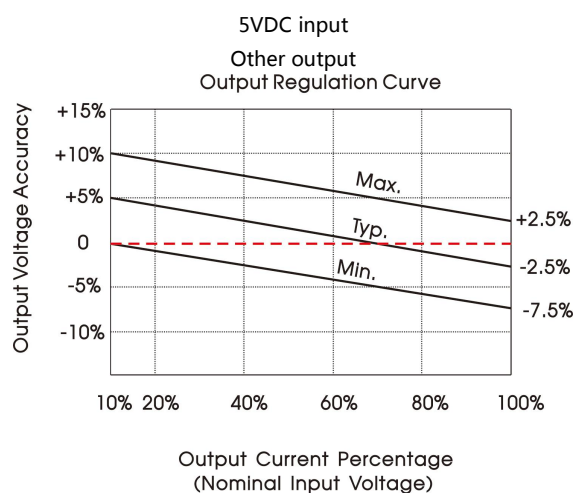
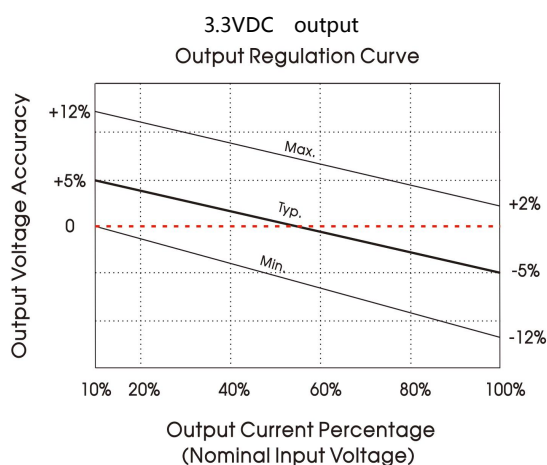

3.3/9/12/15/24VDC input

Other output

Output Regulation Curve

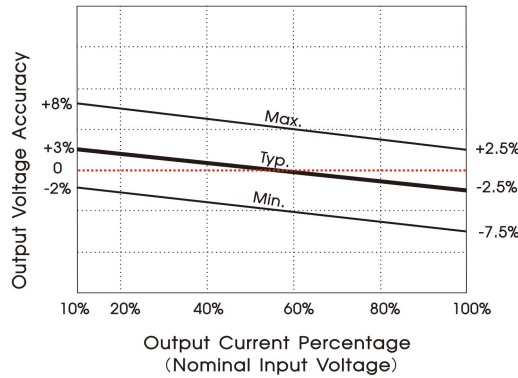
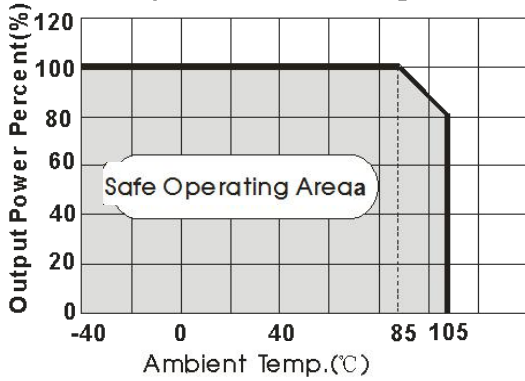

Fig. 1

5VDC input

Temperature Derating Curve



3.3/9/12/15/24VDC input

Temperature Derating Curve

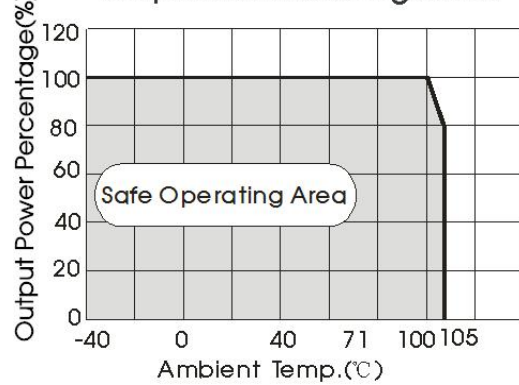
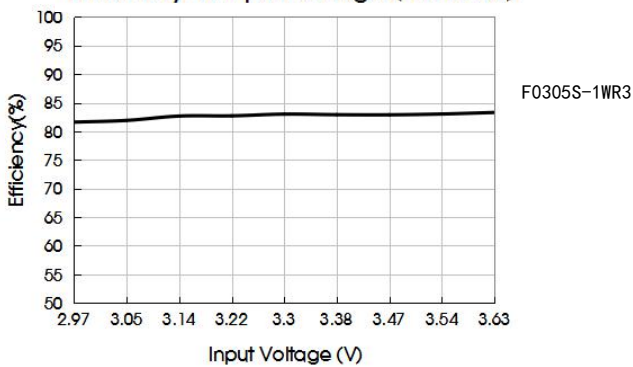
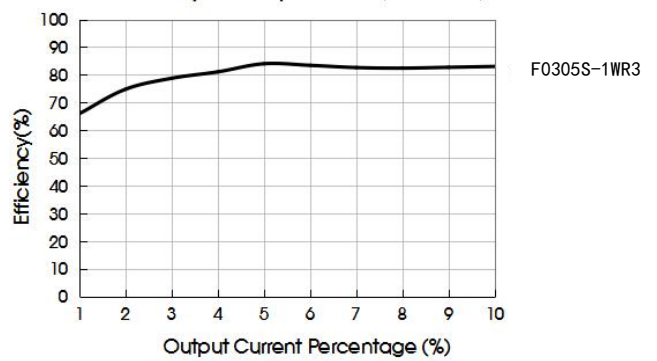

Fig. 2

Efficiency Vs Input Voltage (Full Load)



Efficiency Vs Output Load (Vin=3.3V)



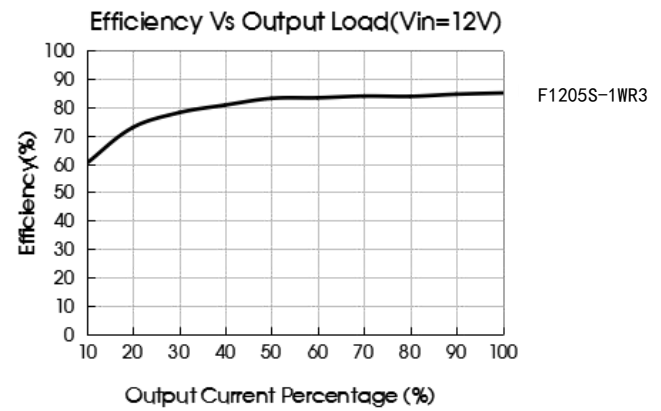
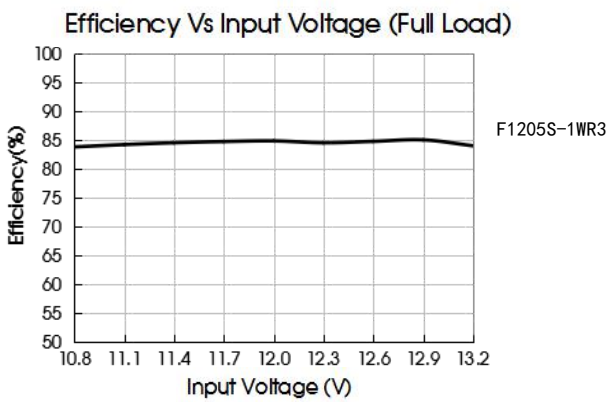
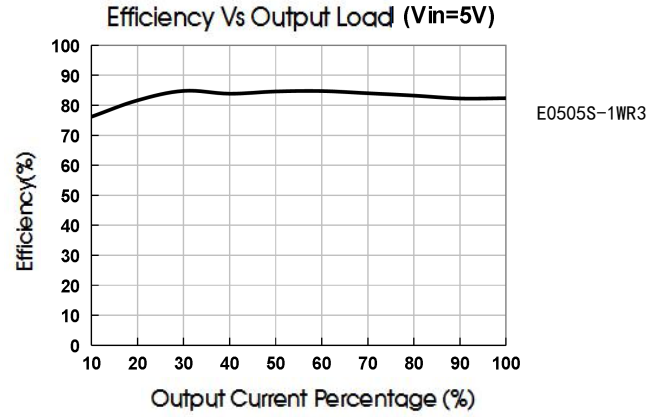
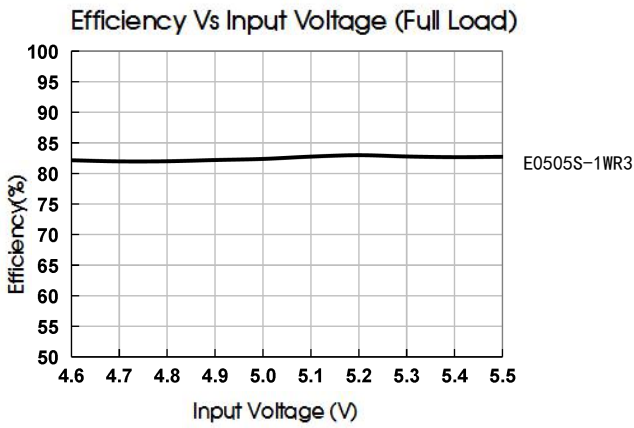

Design Reference

1. Typical application

Input and/or output ripple can be further reduced, by connecting a filter capacitor from the input and/or output terminals to ground as shown in Fig. 3.

Choosing suitable filter capacitor values is very important for a smooth operation of the modules, particularly to avoid start-up problems caused by capacitor values that are too high. For recommended input and output capacitor values refer to Table 1.

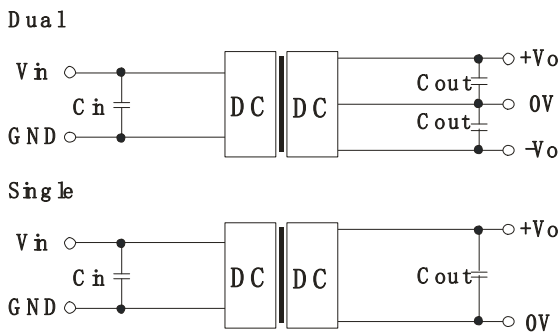

Fig. 3

Table 1: Recommended input and output capacitor values

Vin	Cin	Single output	Cout	Dual output	Cout
3.3VDC	10μF/16V	3.3VDC	10μF/16V	±3.3VDC	4.7μF/16V
5VDC	4.7μF/16V	5VDC	10μF/16V	±5VDC	4.7μF/16V
9VDC	2.2μF/25V	7.2VDC	2.2μF/16V	±9VDC	1μF/16V
12VDC	2.2μF/25V	9VDC	2.2μF/16V	±12VDC	1μF/25V
15VDC	2.2μF/25V	12VDC	2.2μF/25V	±15VDC	0.47μF/25V
24VDC	1μF/50V	15VDC	1μF/25V	±24VDC	0.47μF/50V
--	--	24VDC	1μF/50V	--	--

2. EMC compliance circuit

Dual

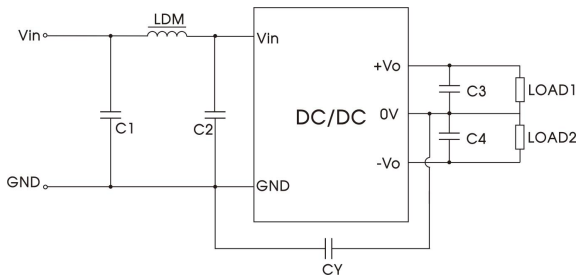

Single

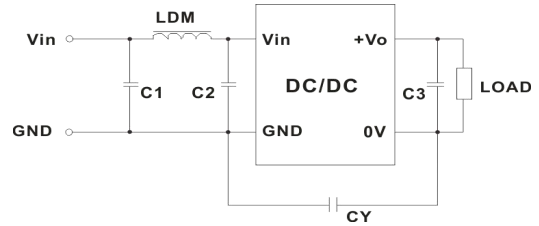

Fig. 4

Table 2: EMC recommended circuit value table

Input voltage		3.3VDC		5VDC		Other input
Output voltage		3.3/5VDC	9/12/15/24VDC	3.3/5/9VDC	12/15/24VDC	--
EMI	C1/C2	4.7uF/16V	4.7uF/16V	4.7uF/25V	4.7uF/25V	4.7uF/50V
	CY	--	270pF /4kVDC VISHAY HGZ102MBP TDK CD45-E2GA102M-GKA	100pF/4kV	1000pF/4kV	270pF /3kVDC
	C3/C4	Refer to the Cout in table 1				
	LDM	6.8μH				

3. For additional information please refer to DC-DC converter application notes on

www.mornsun-power.com

Dimensions and Recommended Layout

THIRD ANGLE PROJECTION 

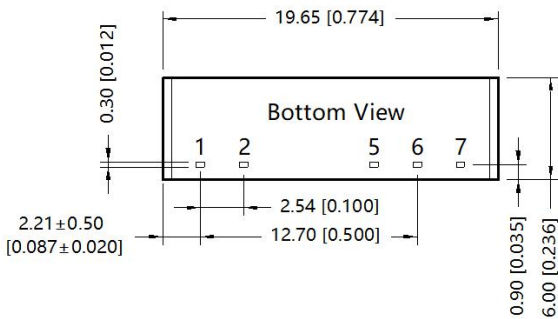
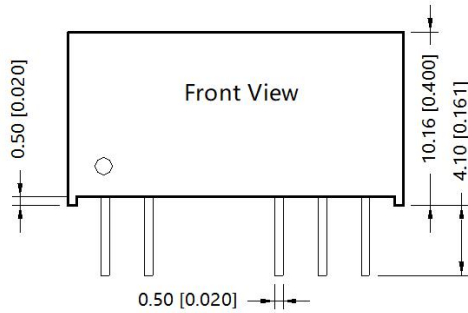

Note:
Unit: mm[inch]
Pin section tolerances: $\pm 0.10[\pm 0.004]$
General tolerances: $\pm 0.25[\pm 0.010]$

Duals Output

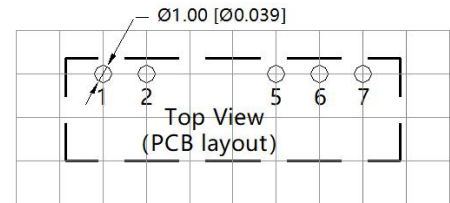

Singles Output

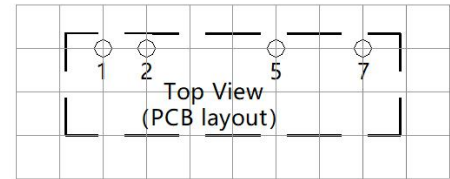

Note: Grid 2.54*2.54mm

Pin	Single	Dual
1	Vin	Vin
2	GND	GND
5	0V	-Vo
6	No Pin	0V
7	+Vo	+Vo

Notes:

1. For additional information on Product Packaging please refer to www.mornsun-power.com. Tube Packaging bag number: 58200001;
2. If the product is not operated within the required load range, the product performance cannot be guaranteed to comply with all parameters in the datasheet;
3. The maximum capacitive load offered were tested at input voltage range and full load;
4. Unless otherwise specified, parameters in this datasheet were measured under the conditions of Ta=25°C, humidity<75%RH with nominal input voltage and rated output load;
5. All index testing methods in this datasheet are based on our company corporate standards;
6. We can provide product customization service, please contact our technicians directly for specific information;
7. Products are related to laws and regulations: see "Features" and "EMC";
8. Our products shall be classified according to ISO14001 and related environmental laws and regulations, and shall be handled by qualified units.

MORNSUN Guangzhou Science & Technology Co., Ltd.

Address: No. 5, Kehui St. 1, Kehui Development Center, Science Ave., Guangzhou Science City, Huangpu District, Guangzhou, P. R. China

Tel: 86-20-38601850

Fax: 86-20-38601272

E-mail: info@mornsun.cn

www.mornsun-power.com