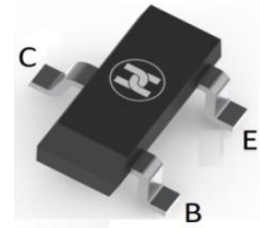
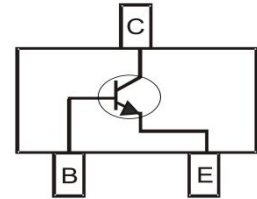

**BIPOLAR TRANSISTOR (NPN)**
**FEATURES**

- Complementary to BC807
- High Collector Current
- Low Collector-emitter saturation voltage
- High current gain
- Surface Mount device

**SOT-23**
**MECHANICAL DATA**

- Case: SOT-23
- Case Material: Molded Plastic. UL flammability
- Classification Rating: 94V-0
- Weight: 0.008 grams (approximate)

**MAXIMUM RATINGS (T<sub>A</sub> = 25°C unless otherwise noted)**

Parameter	Symbol	Value	Unit
Collector-Base Voltage	V <sub>CB0</sub>	50	V
Collector-Emitter Voltage	V <sub>CEO</sub>	45	V
Emitter-Base Voltage	V <sub>EBO</sub>	5	V
Collector Current	I <sub>C</sub>	800	mA
Collector Power Dissipation	P <sub>C</sub>	625	mW
Thermal Resistance From Junction To Ambient	R <sub>θJA</sub>	417	°C/W
Junction Temperature	T <sub>J</sub>	150	°C
Storage Temperature	T <sub>STG</sub>	-55 ~+150	°C

**ELECTRICAL CHARACTERISTICS (T<sub>A</sub> = 25°C unless otherwise specified)**

Parameter	Symbol	Min	Typ	Max	Unit	Conditions
Collector-base breakdown voltage	V <sub>(BR)CBO</sub>	50			V	I <sub>C</sub> =10μA, I <sub>E</sub> =0
Collector-emitter breakdown voltage	V <sub>(BR)CEO</sub>	45			V	I <sub>C</sub> =10mA, I <sub>B</sub> =0
Emitter-base breakdown voltage	V <sub>(BR)EBO</sub>	5			V	I <sub>E</sub> =1μA, I <sub>C</sub> =0
Collector cut-off current	I <sub>CB0</sub>			0.1	μA	V <sub>CB</sub> =50V, I <sub>E</sub> =0
Emitter cut-off current	I <sub>EBO</sub>			0.1	μA	V <sub>EB</sub> =5V, I <sub>C</sub> =0
DC current gain	h <sub>FE1</sub>	100		600		V <sub>CE</sub> =1V, I <sub>C</sub> =100mA
	h <sub>FE2</sub>	40				V <sub>CE</sub> =1V, I <sub>C</sub> =500mA
Collector-emitter saturation voltage	V <sub>CE(sat)</sub>			0.5	V	I <sub>C</sub> =800mA, I <sub>B</sub> =80mA
Base-emitter saturation voltage	V <sub>BE(sat)</sub>			1.2	V	I <sub>C</sub> =800mA, I <sub>B</sub> =80mA
Base-emitter voltage	V <sub>BE</sub>			1.2	V	V <sub>CE</sub> =1V, I <sub>C</sub> =800mA
Transition frequency	f <sub>T</sub>	100			MHz	V <sub>CE</sub> =5V, I <sub>C</sub> =10mA, f=30MHz
Collector output capacitance	C <sub>ob</sub>		10		pF	V <sub>CE</sub> =10V, f=1MHz

**CLASSIFICATION OF h<sub>FE</sub>**

Rank	BC817-16	BC817-25	BC817-40
Range	100-250	160-400	250-600
Marking	6A	6B	6C

**BIPOLAR TRANSISTOR (NPN)**

**Typical Characteristics**

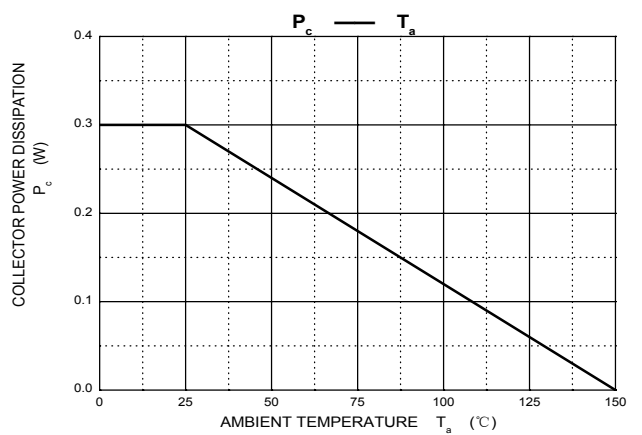
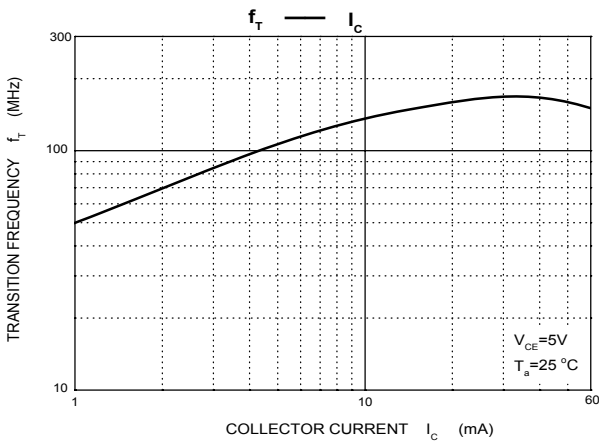
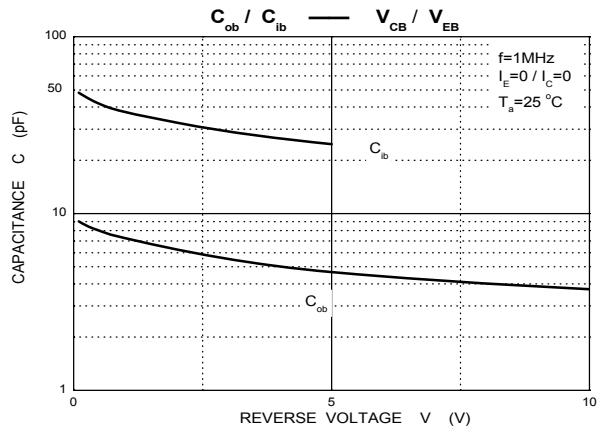
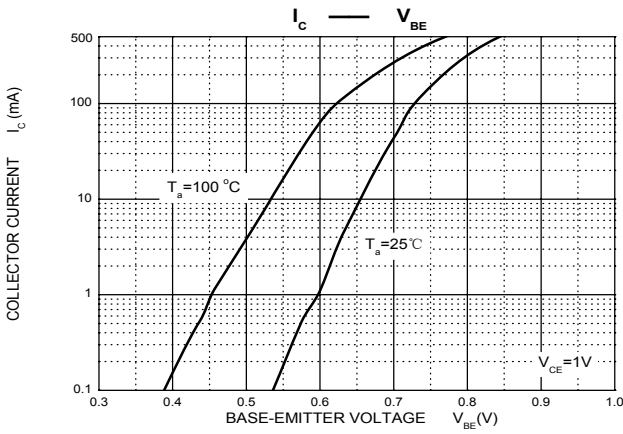
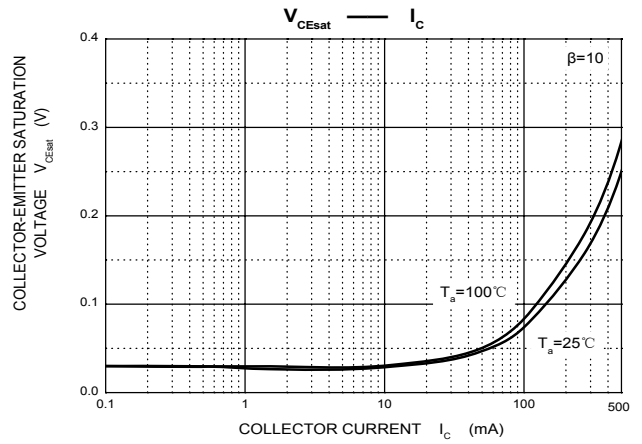
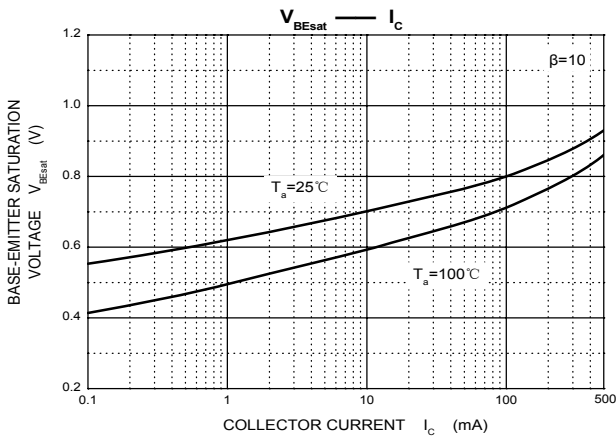
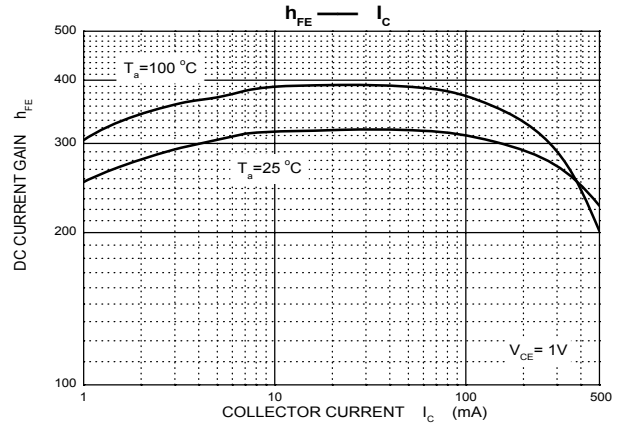
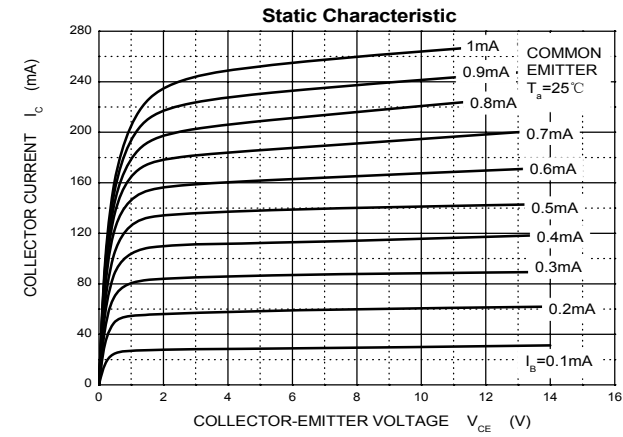

**BIPOLAR TRANSISTOR (NPN)**
**SOT-23 Package Outline Dimensions**

Symbol	Dimensions In Millimeters		Dimensions In Inches	
	Min.	Max.	Min.	Max.
A	0.900	1.150	0.035	0.045
A1	0.000	0.100	0.000	0.004
A2	0.900	1.050	0.035	0.041
b	0.300	0.500	0.012	0.020
c	0.080	0.150	0.003	0.006
D	2.800	3.000	0.110	0.118
E	1.200	1.400	0.047	0.055
E1	2.250	2.550	0.089	0.100
e	0.950 TYP		0.037 TYP	
e1	1.800	2.000	0.071	0.079
L	0.550 REF		0.022 REF	
L1	0.300	0.500	0.012	0.020
θ	0°	8°	0°	8°

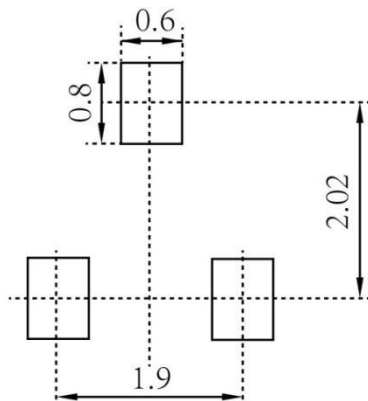
**SOT-23 Suggested Pad Layout**

**Note:**

1. Controlling dimension: in millimeters
2. General tolerance:  $\pm 0.05\text{mm}$
3. The pad layout is for reference purposes only

BIPOLAR TRANSISTOR (NPN)

SOT-23 Tape and Reel

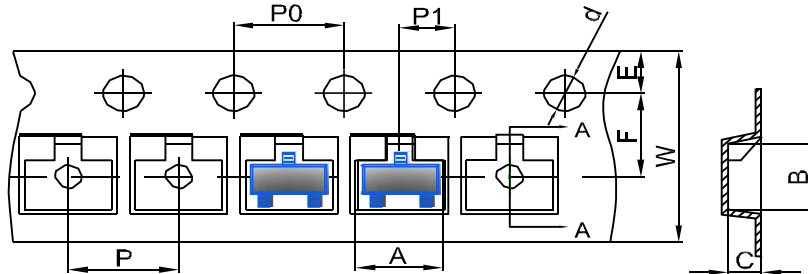
SOT-23 Embossed Carrier Tape



DIMENSIONS ARE IN MILLIMETER										
TYPE	A	B	C	d	E	F	P0	P	P1	W
SOT-23	3.15	2.77	1.22	Ø1.50	1.75	3.50	4.00	4.00	2.00	8.00
TOLERANCE	±0.1	±0.1	±0.1	±0.1	±0.1	±0.1	±0.1	±0.1	±0.1	±0.1

SOT-23 Tape Leader and Trailer

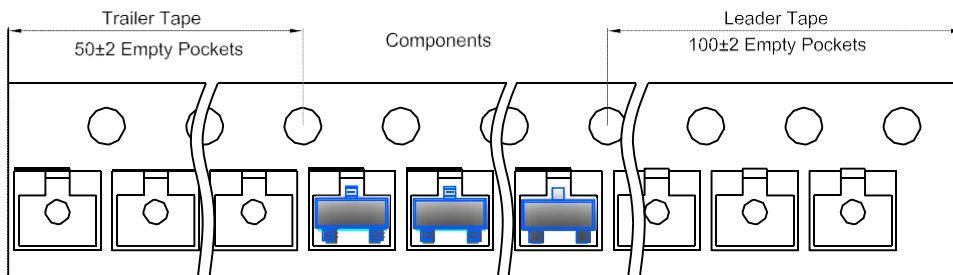

SOT-23 Reel

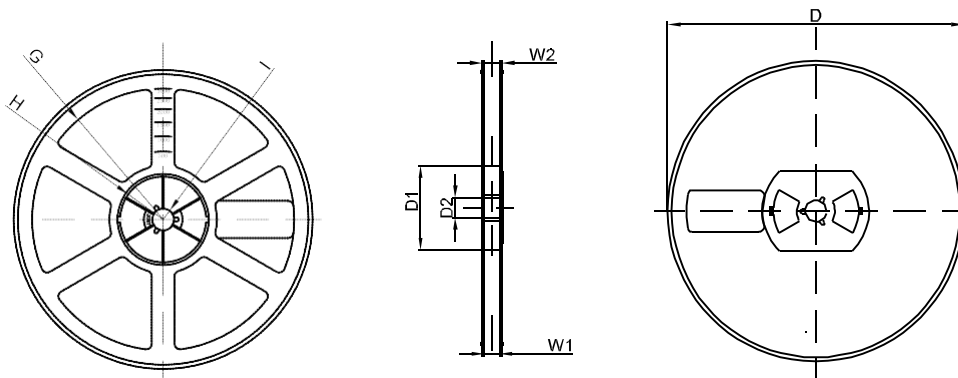

DIMENSIONS ARE IN MILLIMETER								
REEL OPTION	D	D1	D2	G	H	I	W1	W2
7" DIA	Ø178	54.40	13.00	R78	R25.60	R6.50	9.50	12.30
TOLERANCE	±2	±1	±1	±1	±1	±1	±1	±1