

HF7FD

SUBMINIATURE HIGH POWER RELAY



File No.:E134517



File No.: R50457893



File No.: 40008374



File No.:CQC16002153649



Features

- 20A switching capability
- TV-10 load capability
- 2kV dielectric strength (between coil and contacts)
- The ambient temperature can reach 105°C
- Product in accordance to IEC 60335-1 available
- Double pins type available
- 1 Form A and 1 Form C configurations
- UL insulation system:Class F

CONTACT DATA

Contact arrangement	1A	1C
Contact resistance ¹⁾	≤100mΩ (1A 24VDC)	
Contact material	AgSnO ₂	
Contact rating (Res.load)	16A 250VAC 20A 250VAC	NO: 16A 250VAC 20A 250VAC NC: 7A 250VAC/28VDC 10A 250VAC
Max. switching voltage	277VAC / 28VDC	
Max. switching current	20A	20A
Max. switching power	5000VA / 280W	5000VA /280W
Mechanical endurance	1 x 10 ⁷ OPS	
Electrical endurance (See approval reports for more details)	HF7FD	NO:85°C 16A 250VAC 5 x 10 ⁶ OPS Resistive load, 1s on 9s off NO:85°C 20A 250VAC 5 x 10 ⁶ OPS Resistive load, 1s on 9s off NC:85°C 10A 250VAC 5 x 10 ⁶ OPS Resistive load, 1s on 9s off
	HF7FD-T	NO:105°C 17A 125VAC 1x 10 ⁷ OPS Resistive load, 1s on 9s off NO:105°C 12A 250VAC 1x 10 ⁷ OPS Resistive load, 1s on 9s off

Notes: 1) The data shown above are initial values.
2) Open the air permeability hole when testing plastic encapsulated products.

CHARACTERISTICS

Insulation resistance	100MΩ (at 500VDC)	
Dielectric strength	Between coil & contacts	2000VAC 1min
	Between open contacts	750VAC 1min
Operate time (at nomi. volt.)	10ms max.	
Release time (at nomi. volt.)	5ms max.	
Humidity	5% to 85% RH	
Shock resistance	Functional	98m/s ²
	Destructive	980m/s ²
Ambient temperature	-40°C to 105°C	
Vibration resistance	10Hz to 55Hz 1.5mm DA	
Termination	PCB	
Unit weight	Approx. 10g	
Construction	Plastic sealed, Flux proofed	

Notes: 1) The data shown above are initial values.
2) If the ambient temperature is higher than 85 °C, please contact Hongfa.

COIL

Coil power	Approx. 360mW
------------	---------------

COIL DATA

at 23°C

Nominal Voltage VDC	Pick-up Voltage VDC (max. 1)	Drop-out Voltage VDC (min. 1)	Max. Voltage VDC ²⁾	Coil Resistance Ω
3	≤2.25	≥0.3	3.9	25 x (1±10%)
5	≤3.75	≥0.5	6.5	70 x (1±10%)
6	≤4.50	≥0.6	7.8	100 x (1±10%)
9	≤6.75	≥0.9	11.7	225 x (1±10%)
12	≤9.00	≥1.2	15.6	400 x (1±10%)
18	≤13.5	≥1.8	23.4	900 x (1±10%)
24	≤18.0	≥2.4	31.2	1600 x (1±15%)
48	≤36.0	≥4.8	62.4	6400 x (1±15%)

Notes: 1) The data shown above are initial values.
2) *Maximum voltage refers to the maximum voltage which relay coil could endure in a short period of time.

SAFETY APPROVAL RATINGS

UL/CUL	HF7FD	NO:20A 250VAC 85°C (530) 16A 250VAC Resistive load / General load 85°C TV-10 240VAC/120VAC 40°C (530) TV-8 120VAC 40°C (590) 1HP 250VAC 40°C 1/2HP 125VAC 40°C NC:10A 250VAC 85°C (530) 10A 250VAC 40°C 7A 277VAC 85°C 7A 28VDC 85°C
	HF7FD-T	NO:17A 125VAC 105°C TV-10 240VAC/120VAC 40°C (530) TV-8 120VAC 40°C (590) 16A 250VAC Resistive load / General load 85°C 1HP 250VAC 40°C 1/2HP 125VAC 40°C NC:12A 277VAC/250VAC/120VAC 105°C 10A 250VAC 40°C
VDE	HF7FD	NO:16A 250VAC 85°C 17A 250VAC 85°C (530) NC:10A 250VAC 85°C 7A 250VAC 85°C
	HF7FD-T	NO:16A 250VAC 105°C 12A 250VAC 105°C NC:7A 250VAC 105°C
TUV	HF7FD	NO:16A 250VAC 85°C 17A 250VAC 85°C (530) 20A 250VAC 85°C (530) NC:10A 250VAC 85°C (530)
CQC	HF7FD	NO:20A 250VAC 85°C NO:16A 250VAC 85°C NC:10A 250VAC 85°C
	HF7FD-T	NO:16A 250VAC 105°C NC:10A 250VAC 105°C

Notes: Only typical loads are listed above. Other load specifications can be available upon request.



HONGFA RELAY

ISO9001, IATF16949, ISO14001, OHSAS18001, IECQ QC 080000 CERTIFIED

2022 Rev. 1.00

ORDERING INFORMATION

HF7FD / 012-1H P S T F (XXX)	
Type	HF7FD, HF7FD-T
Coil voltage	3, 5, 6, 9, 12, 18, 24, 48VDC
Contact arrangement	1H: 1 Form A 1Z: 1 Form C
Pin version	P: Double pins type Nil: Single pin type
Construction¹⁾	S: Plastic sealed Nil: Flux proofed
Contact material	T: AgSnO ₂
Insulation standard	F: Class F
Special code¹⁾	XXX: Customer special requirement Nil: Standard

- Notes:** 1) Under the ambience with dangerous gas like H₂S, SO₂ or NO₂, plastic sealed type is recommended; Please test the relay in real applications. If the ambience allows, flux proofed type is preferentially recommended.
 2) Contact is recommended for suitable condition and specifications if water cleaning or surface process is involved in assembling relays on PCB.
 3) If plastic sealed type is selected for cleaning purpose, the vent-hole cover should be excised after cleaning.

OUTLINE DIMENSIONS, WIRING DIAGRAM AND PC BOARD LAYOUT

Unit: mm

Outline Dimensions

Wiring Diagram
(Bottom view)

PCB Layout
(Bottom View)

1 Form A (Single pin type)

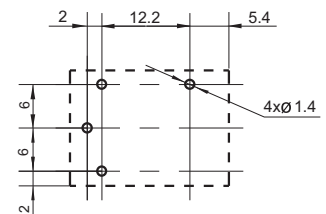
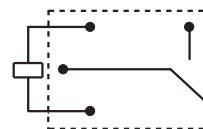
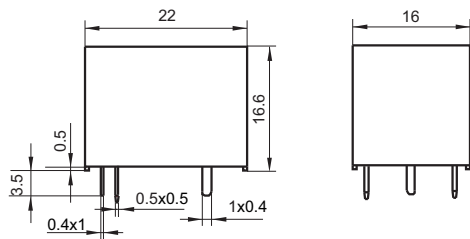

1 Form C (Single pin type)

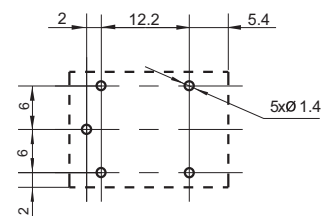
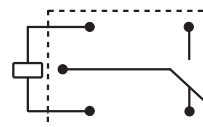
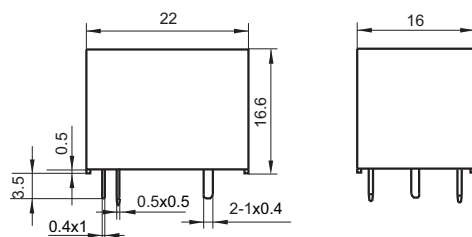

Outline Dimensions

Wiring Diagram
(Bottom View)

PCB Layout
(Bottom view)

(530)1 Form A

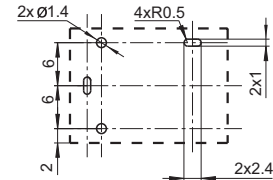
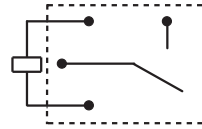
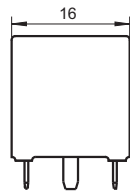
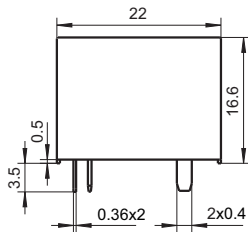

(530)1 Form C

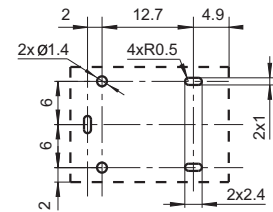
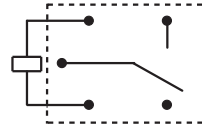
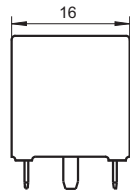
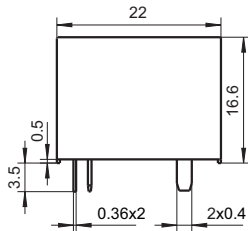

1 Form A (Double pins type)

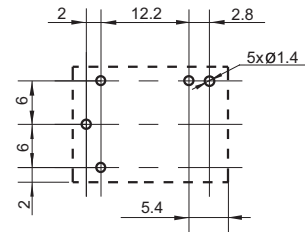
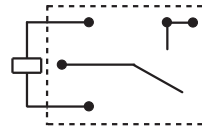
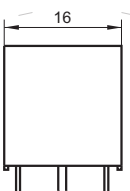
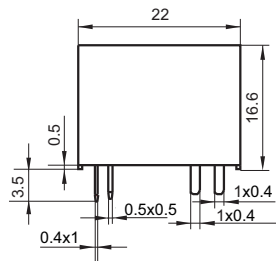

1 Form C (Double pins type)

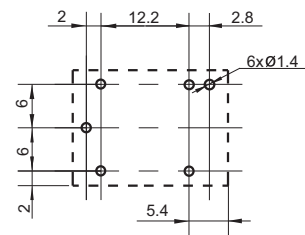
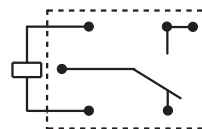
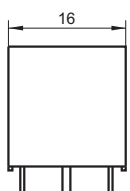
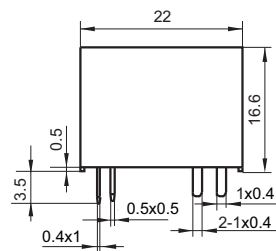

- Remark: 1) The pin dimension of the product outline drawing is the size before tinning (it will become larger after tinning), and the mounting hole size is the recommended design size of the PCB board hole. The specific PCB board hole design size can be mapped and adjusted according to the actual product.
- 2) In case of no tolerance shown in outline dimension: outline dimension $\leq 1\text{mm}$, tolerance should be $\pm 0.2\text{mm}$; outline dimension $> 1\text{mm}$ and $\leq 5\text{mm}$, tolerance should be $\pm 0.3\text{mm}$; outline dimension $> 5\text{mm}$, tolerance should be $\pm 0.4\text{mm}$.
- 3) The tolerance without indicating for PCB layout is always $\pm 0.1\text{mm}$.

CHARACTERISTIC CURVES

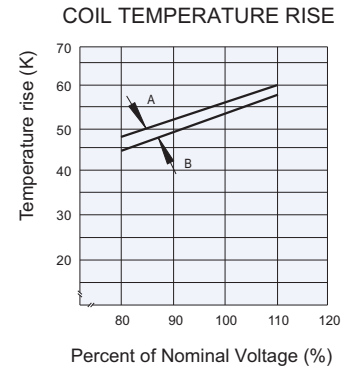
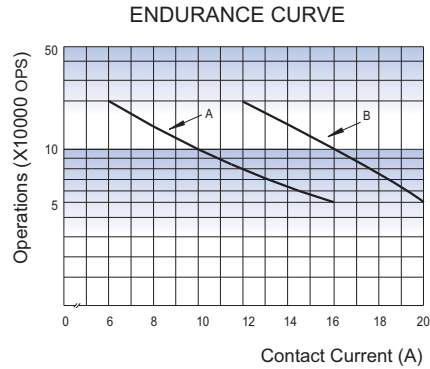
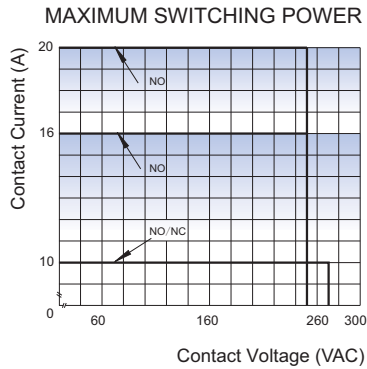

Test conditions:

Curve A: NO, Resistive load, 85°C,
flux proofed, 16A 250VAC, 1s on 9s off
Curve B: NO, Resistive load, 85°C,
flux proofed, 20A 250VAC, 1s on 9s off

Test conditions:

A: 20A at 85°C.
B: 16A at 85°C.
Mounting distance: 25mm

Disclaimer

The specification is for reference only. See to "Terminology and Guidelines" for more information. Specifications subject to change without notice. We could not evaluate all the performance and all the parameters for every possible application. Thus the user should be in a right position to choose the suitable product for their own application. If there is any query, please contact Hongfa for the technical service. However, it is the user's responsibility to determine which product should be used only.

© Xiamen Hongfa Electroacoustic Co., Ltd. All rights of Hongfa are reserved.