

SNx4HC00 Quadruple 2-Input Positive-NAND Gates

1 Features

- Wide Operating Voltage Range of 2 V to 6 V
- Outputs Can Drive Up to 10 LSTTL Loads
- Low Power Consumption: I_{CC} 20- μ A (Maximum)
- Typical t_{pd} : 8 ns
- \pm 4-mA Output Drive at 5 V
- Low Input Current: 1 μ A (Maximum)
- On Products Compliant to MIL-PRF-38535, All Parameters Are Tested Unless Otherwise Noted. On All Other Products, Production Processing Does Not Necessarily Include Testing of All Parameters.

2 Applications

- AV Receivers
- Portable Audio Docks
- Blu-ray Players and Home Theater
- MP3 Players or Recorders
- Personal Digital Assistants (PDAs)
- Power: Telecom or Server AC/DC Supply (Single Controller: Analog and Digital)
- Solid State Drives (SSDs): Client and Enterprise
- TVs: LCD, Digital, and High-Definition (HDTV)
- Tablets: Enterprise
- Video Analytics: Server
- Wireless Headsets, Keyboards, and Mice

3 Description

The SN54HC00 and SN74HC00 devices contain four independent, 2-input $\overline{\text{NAND}}$ gates. They perform the Boolean function $Y = \overline{A \times B}$ or $Y = \overline{A + B}$ in positive logic.

Device Information⁽¹⁾

PART NUMBER	PACKAGE (PINS)	BODY SIZE (NOM)
SN54HC00	CDIP (14)	6.92 mm x 19.94 mm
	CFP (14)	6.20 mm x 9.41 mm
	LCCC (20)	8.89 mm x 8.89 mm
SN74HC00D	SOIC (14)	8.65 mm x 3.91 mm
SN74HC00DB	SSOP (14)	6.20 mm x 5.30 mm
SN74HC00N	PDIP (14)	19.30 mm x 6.35 mm
SN74HC00NS	SOP (14)	10.30 mm x 5.30 mm
SN74HC00PW	TSSOP (14)	5.00 mm x 4.40 mm

(1) For all available packages, see the orderable addendum at the end of the data sheet.

Logic Diagram (Positive Logic)

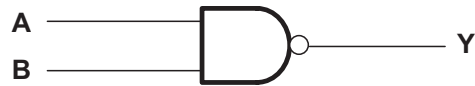

Copyright © 2016, Texas Instruments Incorporated



Table of Contents

1 Features	1	8.4 Device Functional Modes.....	8
2 Applications	1	9 Application and Implementation	9
3 Description	1	9.1 Application Information.....	9
4 Revision History	2	9.2 Typical Application	9
5 Pin Configuration and Functions	3	10 Power Supply Recommendations	10
6 Specifications	4	11 Layout	10
6.1 Absolute Maximum Ratings	4	11.1 Layout Guidelines	10
6.2 ESD Ratings.....	4	11.2 Layout Example	10
6.3 Recommended Operating Conditions.....	4	12 Device and Documentation Support	11
6.4 Thermal Information	5	12.1 Documentation Support	11
6.5 Electrical Characteristics.....	5	12.2 Related Links	11
6.6 Switching Characteristics	6	12.3 Receiving Notification of Documentation Updates	11
6.7 Typical Characteristics	6	12.4 Community Resources.....	11
7 Parameter Measurement Information	7	12.5 Trademarks	11
8 Detailed Description	8	12.6 Electrostatic Discharge Caution.....	11
8.1 Overview	8	12.7 Glossary	11
8.2 Functional Block Diagram	8	13 Mechanical, Packaging, and Orderable	
8.3 Feature Description.....	8	Information	11

4 Revision History

NOTE: Page numbers for previous revisions may differ from page numbers in the current version.

Changes from Revision E (August 2003) to Revision F	Page
• Added <i>Applications</i> section, <i>Device Information</i> table, <i>ESD Ratings</i> table, <i>Typical Characteristics</i> section, <i>Feature Description</i> section, <i>Device Functional Modes</i> , <i>Application and Implementation</i> section, <i>Power Supply Recommendations</i> section, <i>Layout</i> section, <i>Device and Documentation Support</i> section, and <i>Mechanical, Packaging, and Orderable Information</i> section	1
• Added Military Disclaimer to Features list	1
• Removed <i>Ordering Information</i> table; see POA at the end of data sheet.....	1
• Changed values in the <i>Thermal Information</i> table to align with JEDEC standards.....	5
• Deleted <i>Operating Characteristics</i> table; moved Cpd row to <i>Electrical Characteristics</i>	5

5 Pin Configuration and Functions

**D, DB, J, N, NS, PW, and W Package
14-Pin SOIC, SSOP, CDIP, PDIP, SOP, TSSOP, and CFP
Top View**

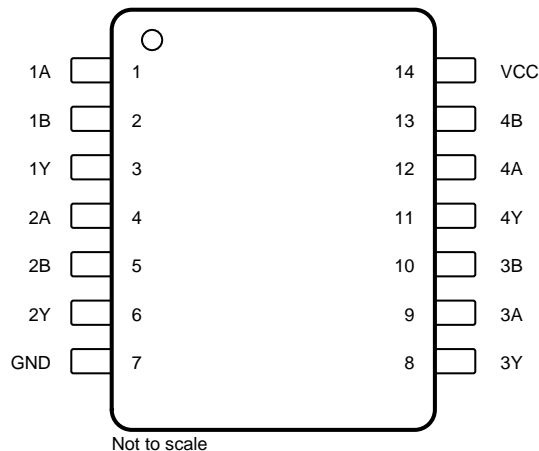

Not to scale

**FK Package
20-Pin LCCC
Top View**

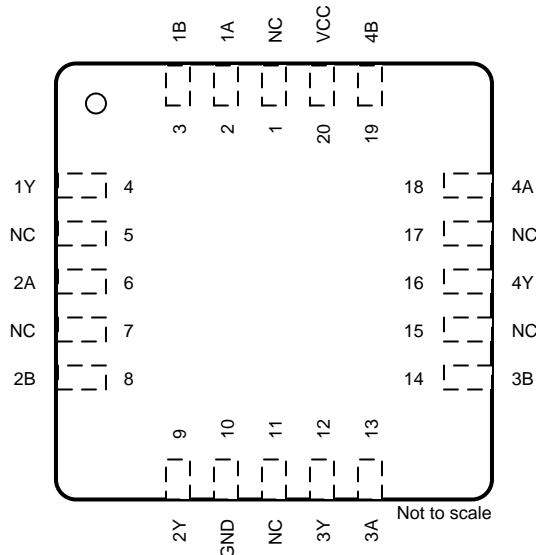

Not to scale

Pin Functions

NAME	PIN		I/O	DESCRIPTION
	SOIC, SSOP, CDIP, PDIP, SOP, TSSOP, CFP	LCCC		
1A	1	2	I	Gate 1 input
1B	2	3	I	Gate 1 input
1Y	3	4	O	Gate 1 output
2A	4	6	I	Gate 2 input
2B	5	8	I	Gate 2 input
2Y	6	9	O	Gate 2 output
3A	9	13	I	Gate 3 input
3B	10	14	I	Gate 3 input
3Y	8	12	O	Gate 3 output
4A	12	18	I	Gate 4 input
4B	13	19	I	Gate 4 input
4Y	11	16	O	Gate 4 output
GND	7	10	—	Ground pin
NC	—	1, 5, 7, 11, 15, 17	—	No internal connection
V _{CC}	14	20	—	Power pin

6 Specifications

6.1 Absolute Maximum Ratings

over operating free-air temperature range (unless otherwise noted)⁽¹⁾

	MIN	MAX	UNIT
Supply voltage, V_{CC}	-0.5	7	V
Input clamp current, I_{IK} ($V_I < 0$ or $V_I > V_{CC}$) ⁽²⁾		±20	mA
Output clamp current, I_{OK} ($V_O < 0$ or $V_O > V_{CC}$) ⁽²⁾		±20	mA
Continuous output current, I_O ($V_O = 0$ to V_{CC})		±25	mA
Continuous current through V_{CC} or GND		±50	mA
Storage temperature, T_{stg}	-65	150	°C

- (1) Stresses beyond those listed under *Absolute Maximum Ratings* may cause permanent damage to the device. These are stress ratings only, which do not imply functional operation of the device at these or any other conditions beyond those indicated under *Recommended Operating Conditions*. Exposure to absolute-maximum-rated conditions for extended periods may affect device reliability.
- (2) The input and output voltage ratings may be exceeded if the input and output current ratings are observed.

6.2 ESD Ratings

		VALUE	UNIT
$V_{(ESD)}$ Electrostatic discharge	Human-body model (HBM), per ANSI/ESDA/JEDEC JS-001 ⁽¹⁾	±2000	V
	Charged-device model (CDM), per JEDEC specification JESD22-C101 ⁽²⁾	±1000	

- (1) JEDEC document JEP155 states that 500-V HBM allows safe manufacturing with a standard ESD control process.
- (2) JEDEC document JEP157 states that 250-V CDM allows safe manufacturing with a standard ESD control process.

6.3 Recommended Operating Conditions

over operating free-air temperature range (unless otherwise noted)⁽¹⁾

		MIN	NOM	MAX	UNIT
V_{CC}	Supply voltage	2	5	6	V
V_{IH}	High-level input voltage	$V_{CC} = 2$ V	1.5		V
		$V_{CC} = 4.5$ V	3.15		
		$V_{CC} = 6$ V	4.2		
V_{IL}	Low-level input voltage	$V_{CC} = 2$ V		0.5	V
		$V_{CC} = 4.5$ V		1.35	
		$V_{CC} = 6$ V		1.8	
V_I	Input voltage	0		V_{CC}	V
V_O	Output voltage	0		V_{CC}	V
$\Delta t/\Delta v$	Input transition rise and fall time	$V_{CC} = 2$ V		1000	ns
		$V_{CC} = 4.5$ V		500	
		$V_{CC} = 6$ V		400	
T_A	Operating free-air temperature	SN54HC00	-55	125	°C
		SN74HC00	-40	85	

- (1) All unused inputs of the device must be held at V_{CC} or GND to ensure proper device operation. Refer to [Implications of Slow or Floating CMOS Inputs](#) application report.

6.4 Thermal Information

THERMAL METRIC ⁽¹⁾	SN74HC00					UNIT	
	D (SOIC)	DB (SSOP)	N (PDIP)	NS (SOP)	PW (TSSOP)		
	14 PINS	14 PINS	14 PINS	14 PINS	14 PINS		
$R_{\theta JA}$	Junction-to-ambient thermal resistance	94.7	108.3	57.5	91	122.9	°C/W
$R_{\theta JC(top)}$	Junction-to-case (top) thermal resistance	54.6	60.3	45.1	48.8	51.5	°C/W
$R_{\theta JB}$	Junction-to-board thermal resistance	49	55.7	37.3	49.8	64.6	°C/W
Ψ_{JT}	Junction-to-top characterization parameter	21.1	25	30.3	18.4	6.6	°C/W
Ψ_{JB}	Junction-to-board characterization parameter	48.7	55.2	37.2	49.5	64	°C/W

(1) For more information about traditional and new thermal metrics, see the [Semiconductor and IC Package Thermal Metrics](#) application report.

6.5 Electrical Characteristics

over recommended operating free-air temperature range (unless otherwise noted)

PARAMETER	TEST CONDITIONS	MIN	TYP	MAX	UNIT		
V_{OH}	$V_I = V_{IH}$ or V_{IL}	$I_{OH} = -20 \mu A$	$V_{CC} = 2 V$	1.9	1.998	V	
			$V_{CC} = 4.5 V$	4.4	4.499		
			$V_{CC} = 6 V$	5.9	5.999		
		$I_{OH} = -4 mA, V_{CC} = 4.5 V$	$T_A = 25^\circ C$	3.98	4.3		
			SN54HC00	3.7			
			SN74HC00	3.84			
		$I_{OH} = -5.2 mA, V_{CC} = 6 V$	$T_A = 25^\circ C$	5.48	5.8		
			SN54HC00	5.2			
SN74HC00	5.34						
V_{OL}	$V_I = V_{IH}$ or V_{IL}	$I_{OL} = 20 \mu A$	$V_{CC} = 2 V$		0.002	0.1	V
			$V_{CC} = 4.5 V$		0.001	0.1	
			$V_{CC} = 6 V$		0.001	0.1	
		$I_{OL} = 4 mA, V_{CC} = 4.5 V$	$T_A = 25^\circ C$		0.17	0.26	
			SN54HC00			0.4	
			SN74HC00			0.33	
		$I_{OL} = 5.2 mA, V_{CC} = 6 V$	$T_A = 25^\circ C$		0.15	0.26	
			SN54HC00			0.4	
SN74HC00				0.33			
I_I	$V_I = V_{CC}$ or 0, $V_{CC} = 6 V$	$T_A = 25^\circ C$		± 0.1	± 100	nA	
		SNx4HC00			± 1000		
I_{CC}	$V_I = V_{CC}$ or 0, $I_O = 0$, $V_{CC} = 6 V$	$T_A = 25^\circ C$			2	μA	
		SN54HC00			40		
		SN74HC00			20		
C_i	$V_{CC} = 2 V$ to $6 V$			3	10	pF	
C_{pd}	Power dissipation capacitance per gate No load, $T_A = 25^\circ C$			20		pF	

6.6 Switching Characteristics

over recommended operating free-air temperature range, $C_L = 50$ pF, see [Figure 2](#) (unless otherwise noted)

PARAMETER	TEST CONDITIONS		MIN	TYP	MAX	UNIT
t_{pd}	From A or B (input) to Y (output)	$V_{CC} = 2$ V	$T_A = 25^\circ\text{C}$	45	90	ns
			SN54HC00	135		
			SN74HC00	115		
		$V_{CC} = 4.5$ V	$T_A = 25^\circ\text{C}$	9	18	
			SN54HC00	27		
			SN74HC00	23		
		$V_{CC} = 6$ V	$T_A = 25^\circ\text{C}$	8	15	
			SN54HC00	23		
			SN74HC00	20		
t_t	To Y (output)	$V_{CC} = 2$ V	$T_A = 25^\circ\text{C}$	38	75	ns
			SN54HC00	110		
			SN74HC00	95		
		$V_{CC} = 4.5$ V	$T_A = 25^\circ\text{C}$	8	15	
			SN54HC00	22		
			SN74HC00	19		
		$V_{CC} = 6$ V	$T_A = 25^\circ\text{C}$	6	13	
			SN54HC00	19		
			SN74HC00	16		

6.7 Typical Characteristics

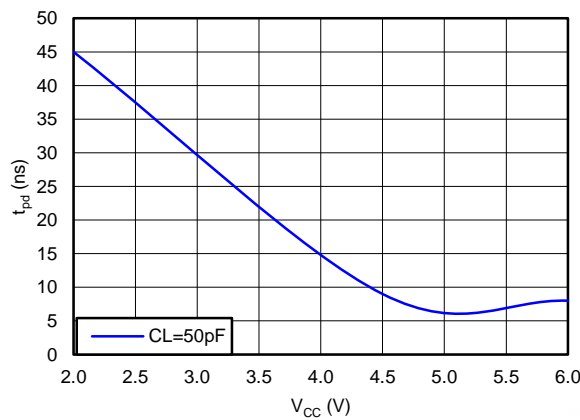
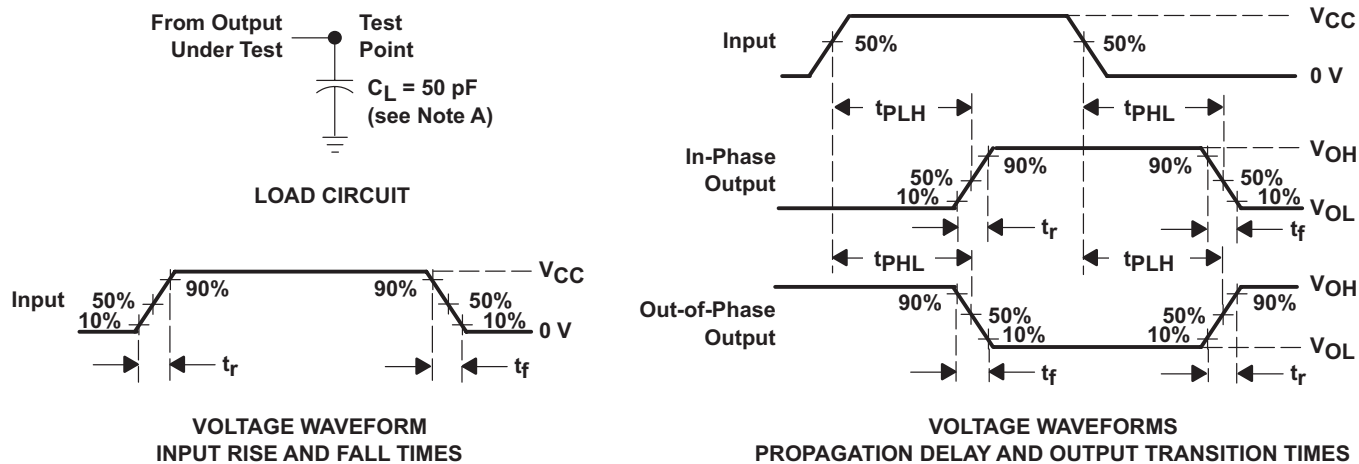

Figure 1. Propagation Delay vs V_{CC}

7 Parameter Measurement Information



- NOTES:
- A. C_L includes probe and test-fixtue capacitance.
 - B. Phase relationships between waveforms were chosen arbitrarily. All input pulses are supplied by generators having the following characteristics: $PRR \leq 1 \text{ MHz}$, $Z_O = 50 \Omega$, $t_r = 6 \text{ ns}$, $t_f = 6 \text{ ns}$.
 - C. The outputs are measured one at a time with one input transition per measurement.
 - D. t_{PLH} and t_{PHL} are the same as t_{pd} .

Figure 2. Load Circuit and Voltage Waveforms

8 Detailed Description

8.1 Overview

The SNx4HC00 devices perform the NAND Boolean function $Y = \bar{A} \times \bar{B}$ or $Y = \bar{A} + \bar{B}$ in positive logic. The devices have a wide operating range of V_{CC} from 2 V to 6 V.

8.2 Functional Block Diagram

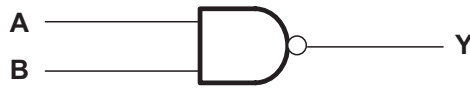

Copyright © 2016, Texas Instruments Incorporated

8.3 Feature Description

The SNx4HC00 devices have a wide operating voltage range that operates from 2 V to 6 V. They allow inputs and outputs up to V_{CC} . The devices can drive outputs at 4 mA at 5-V V_{CC} .

8.4 Device Functional Modes

[Table 1](#) lists the functional modes for the SNx4HC00.

Table 1. Function Table

INPUTS		OUTPUT
A	B	Y
H	H	L
L	X	H
X	L	H

9 Application and Implementation

NOTE

Information in the following applications sections is not part of the TI component specification, and TI does not warrant its accuracy or completeness. TI's customers are responsible for determining suitability of components for their purposes. Customers should validate and test their design implementation to confirm system functionality.

9.1 Application Information

The SNx4HC00 is a low-power, wide-operating-voltage NAND gate. This device can drive up to 10 LSTTL loads and can drive 4-mA outputs at 5-V V_{CC} .

9.2 Typical Application

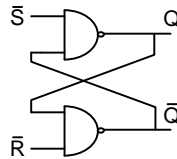

Copyright © 2016,
Texas Instruments Incorporated

Figure 3. Typical NAND Gate Application and Supply Voltage

9.2.1 Design Requirements

The SNx4HC00 devices use CMOS technology and have balanced output drive. Take care to avoid bus contention because it drives currents that would exceed maximum limits. The high drive also creates fast edges into light loads. Routing and load conditions must be considered to prevent ringing.

9.2.2 Detailed Design Procedure

- Recommended input conditions:
 - Specified high and low levels. See V_{IH} and V_{IL} in [Recommended Operating Conditions](#).
- Recommended output conditions:
 - Load currents must not exceed 25 mA per output and 50 mA total for the part.
 - Outputs must not be pulled above V_{CC} .

9.2.3 Application Curve

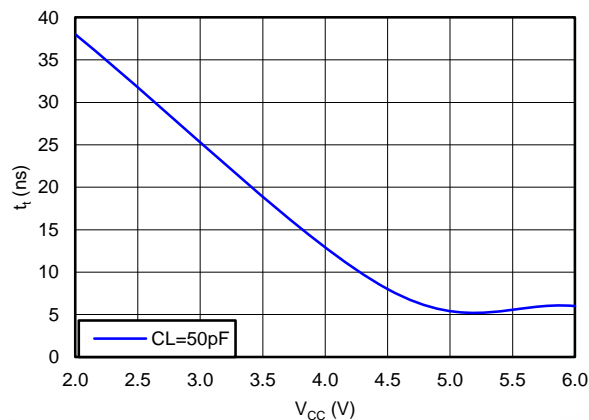

Figure 4. Transition Time vs V_{CC}

10 Power Supply Recommendations

The power supply can be any voltage between the MIN and MAX supply voltage rating located in [Recommended Operating Conditions](#).

Each V_{CC} pin must have a good bypass capacitor to prevent power disturbance. For devices with a single supply, TI recommends a 0.1- μF bypass capacitor; if there are multiple V_{CC} pins, then TI recommends 0.01- μF or 0.022- μF bypass capacitors for each power pin. It is acceptable to parallel multiple bypass capacitors to reject different frequencies of noise. A 0.1 μF and a 1 μF are commonly used in parallel. The bypass capacitor must be installed as close to the power pin as possible for best results.

11 Layout

11.1 Layout Guidelines

When using multiple bit logic devices inputs must never float.

In many cases, functions or parts of functions of digital logic devices are unused, for example, when only two inputs of a triple-input and gate are used or only 3 of the 4 buffer gates are used. Such input pins must not be left unconnected because the undefined voltages at the outside connections result in undefined operational states. [Figure 5](#) specifies the rules that must be observed under all circumstances. All unused inputs of digital logic devices must be connected to a high or low bias to prevent them from floating. The logic level that must be applied to any particular unused input depends on the function of the device. Generally they are tied to GND or V_{CC} , whichever makes more sense or is more convenient. It is generally acceptable to float outputs, unless the part is a transceiver.

11.2 Layout Example

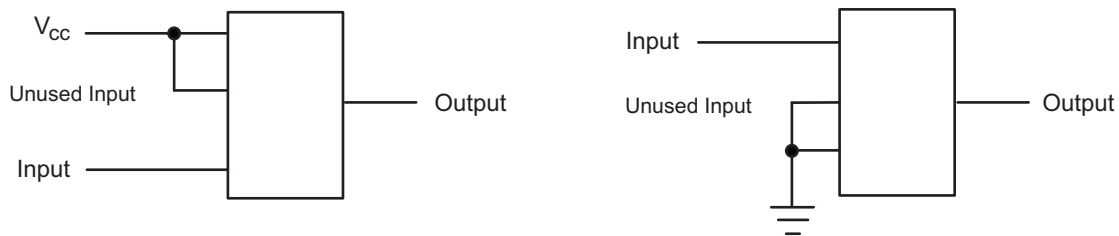

Figure 5. Layout Diagram

12 Device and Documentation Support

12.1 Documentation Support

12.1.1 Related Documentation

For related documentation see the following:

[Implications of Slow or Floating CMOS Inputs](#) (SCBA004)

12.2 Related Links

The table below lists quick access links. Categories include technical documents, support and community resources, tools and software, and quick access to sample or buy.

Table 2. Related Links

PARTS	PRODUCT FOLDER	SAMPLE & BUY	TECHNICAL DOCUMENTS	TOOLS & SOFTWARE	SUPPORT & COMMUNITY
SN54HC00	Click here	Click here	Click here	Click here	Click here
SN74HC00	Click here	Click here	Click here	Click here	Click here

12.3 Receiving Notification of Documentation Updates

To receive notification of documentation updates, navigate to the device product folder on ti.com. In the upper right corner, click on *Alert me* to register and receive a weekly digest of any product information that has changed. For change details, review the revision history included in any revised document.

12.4 Community Resources

The following links connect to TI community resources. Linked contents are provided "AS IS" by the respective contributors. They do not constitute TI specifications and do not necessarily reflect TI's views; see TI's [Terms of Use](#).

TI E2E™ Online Community *TI's Engineer-to-Engineer (E2E) Community*. Created to foster collaboration among engineers. At e2e.ti.com, you can ask questions, share knowledge, explore ideas and help solve problems with fellow engineers.

Design Support *TI's Design Support* Quickly find helpful E2E forums along with design support tools and contact information for technical support.

12.5 Trademarks

E2E is a trademark of Texas Instruments.
All other trademarks are the property of their respective owners.

12.6 Electrostatic Discharge Caution



These devices have limited built-in ESD protection. The leads should be shorted together or the device placed in conductive foam during storage or handling to prevent electrostatic damage to the MOS gates.

12.7 Glossary

[SLYZ022](#) — *TI Glossary*.

This glossary lists and explains terms, acronyms, and definitions.

13 Mechanical, Packaging, and Orderable Information

The following pages include mechanical, packaging, and orderable information. This information is the most current data available for the designated devices. This data is subject to change without notice and revision of this document. For browser-based versions of this data sheet, refer to the left-hand navigation.

PACKAGING INFORMATION

Orderable Device	Status (1)	Package Type	Package Drawing	Pins	Package Qty	Eco Plan (2)	Lead/Ball Finish (6)	MSL Peak Temp (3)	Op Temp (°C)	Device Marking (4/5)	Samples
5962-8403701VCA	ACTIVE	CDIP	J	14	1	TBD	A42	N / A for Pkg Type	-55 to 125	5962-8403701VC A SNV54HC00J	Samples
5962-8403701VDA	ACTIVE	CFP	W	14	1	TBD	A42	N / A for Pkg Type	-55 to 125	5962-8403701VD A SNV54HC00W	Samples
84037012A	ACTIVE	LCCC	FK	20	1	TBD	POST-PLATE	N / A for Pkg Type	-55 to 125	84037012A SNJ54HC 00FK	Samples
8403701CA	ACTIVE	CDIP	J	14	1	TBD	A42	N / A for Pkg Type	-55 to 125	8403701CA SNJ54HC00J	Samples
8403701DA	ACTIVE	CFP	W	14	1	TBD	A42	N / A for Pkg Type	-55 to 125	8403701DA SNJ54HC00W	Samples
JM38510/65001B2A	ACTIVE	LCCC	FK	20	1	TBD	POST-PLATE	N / A for Pkg Type	-55 to 125	JM38510/ 65001B2A	Samples
JM38510/65001BCA	ACTIVE	CDIP	J	14	1	TBD	A42	N / A for Pkg Type	-55 to 125	JM38510/ 65001BCA	Samples
JM38510/65001BDA	ACTIVE	CFP	W	14	1	TBD	A42	N / A for Pkg Type	-55 to 125	JM38510/ 65001BDA	Samples
M38510/65001B2A	ACTIVE	LCCC	FK	20	1	TBD	POST-PLATE	N / A for Pkg Type	-55 to 125	JM38510/ 65001B2A	Samples
M38510/65001BCA	ACTIVE	CDIP	J	14	1	TBD	A42	N / A for Pkg Type	-55 to 125	JM38510/ 65001BCA	Samples
M38510/65001BDA	ACTIVE	CFP	W	14	1	TBD	A42	N / A for Pkg Type	-55 to 125	JM38510/ 65001BDA	Samples
SN54HC00J	ACTIVE	CDIP	J	14	1	TBD	A42	N / A for Pkg Type	-55 to 125	SN54HC00J	Samples
SN74HC00D	ACTIVE	SOIC	D	14	50	Green (RoHS & no Sb/Br)	CU NIPDAU	Level-1-260C-UNLIM	-40 to 85	HC00	Samples
SN74HC00DBR	ACTIVE	SSOP	DB	14	2000	Green (RoHS & no Sb/Br)	CU NIPDAU	Level-1-260C-UNLIM	-40 to 85	HC00	Samples
SN74HC00DE4	ACTIVE	SOIC	D	14	50	Green (RoHS & no Sb/Br)	CU NIPDAU	Level-1-260C-UNLIM	-40 to 85	HC00	Samples
SN74HC00DG4	ACTIVE	SOIC	D	14	50	Green (RoHS & no Sb/Br)	CU NIPDAU	Level-1-260C-UNLIM	-40 to 85	HC00	Samples

Orderable Device	Status (1)	Package Type	Package Drawing	Pins	Package Qty	Eco Plan (2)	Lead/Ball Finish (6)	MSL Peak Temp (3)	Op Temp (°C)	Device Marking (4/5)	Samples
SN74HC00DR	ACTIVE	SOIC	D	14	2500	Green (RoHS & no Sb/Br)	CU NIPDAU CU SN	Level-1-260C-UNLIM	-40 to 85	HC00	Samples
SN74HC00DRE4	ACTIVE	SOIC	D	14	2500	Green (RoHS & no Sb/Br)	CU NIPDAU	Level-1-260C-UNLIM	-40 to 85	HC00	Samples
SN74HC00DRG4	ACTIVE	SOIC	D	14	2500	Green (RoHS & no Sb/Br)	CU NIPDAU	Level-1-260C-UNLIM	-40 to 85	HC00	Samples
SN74HC00DT	ACTIVE	SOIC	D	14	250	Green (RoHS & no Sb/Br)	CU NIPDAU	Level-1-260C-UNLIM	-40 to 85	HC00	Samples
SN74HC00DTE4	ACTIVE	SOIC	D	14	250	Green (RoHS & no Sb/Br)	CU NIPDAU	Level-1-260C-UNLIM	-40 to 85	HC00	Samples
SN74HC00DTG4	ACTIVE	SOIC	D	14	250	Green (RoHS & no Sb/Br)	CU NIPDAU	Level-1-260C-UNLIM	-40 to 85	HC00	Samples
SN74HC00N	ACTIVE	PDIP	N	14	25	Pb-Free (RoHS)	CU NIPDAU CU SN	N / A for Pkg Type	-40 to 85	SN74HC00N	Samples
SN74HC00NE4	ACTIVE	PDIP	N	14	25	Pb-Free (RoHS)	CU NIPDAU	N / A for Pkg Type	-40 to 85	SN74HC00N	Samples
SN74HC00NSR	ACTIVE	SO	NS	14	2000	Green (RoHS & no Sb/Br)	CU NIPDAU	Level-1-260C-UNLIM	-40 to 85	HC00	Samples
SN74HC00PW	ACTIVE	TSSOP	PW	14	90	Green (RoHS & no Sb/Br)	CU NIPDAU	Level-1-260C-UNLIM	-40 to 85	HC00	Samples
SN74HC00PWG4	ACTIVE	TSSOP	PW	14	90	Green (RoHS & no Sb/Br)	CU NIPDAU	Level-1-260C-UNLIM	-40 to 85	HC00	Samples
SN74HC00PWR	ACTIVE	TSSOP	PW	14	2000	Green (RoHS & no Sb/Br)	CU NIPDAU CU SN	Level-1-260C-UNLIM	-40 to 85	HC00	Samples
SN74HC00PWRG4	ACTIVE	TSSOP	PW	14	2000	Green (RoHS & no Sb/Br)	CU NIPDAU	Level-1-260C-UNLIM	-40 to 85	HC00	Samples
SN74HC00PWT	ACTIVE	TSSOP	PW	14	250	Green (RoHS & no Sb/Br)	CU NIPDAU	Level-1-260C-UNLIM	-40 to 85	HC00	Samples
SNJ54HC00FK	ACTIVE	LCCC	FK	20	1	TBD	POST-PLATE	N / A for Pkg Type	-55 to 125	84037012A SNJ54HC 00FK	Samples
SNJ54HC00J	ACTIVE	CDIP	J	14	1	TBD	A42	N / A for Pkg Type	-55 to 125	8403701CA SNJ54HC00J	Samples
SNJ54HC00W	ACTIVE	CFP	W	14	1	TBD	A42	N / A for Pkg Type	-55 to 125	8403701DA SNJ54HC00W	Samples

(1) The marketing status values are defined as follows:

ACTIVE: Product device recommended for new designs.

LIFEBUY: TI has announced that the device will be discontinued, and a lifetime-buy period is in effect.

NRND: Not recommended for new designs. Device is in production to support existing customers, but TI does not recommend using this part in a new design.

PREVIEW: Device has been announced but is not in production. Samples may or may not be available.

OBSOLETE: TI has discontinued the production of the device.

(2) Eco Plan - The planned eco-friendly classification: Pb-Free (RoHS), Pb-Free (RoHS Exempt), or Green (RoHS & no Sb/Br) - please check <http://www.ti.com/productcontent> for the latest availability information and additional product content details.

TBD: The Pb-Free/Green conversion plan has not been defined.

Pb-Free (RoHS): TI's terms "Lead-Free" or "Pb-Free" mean semiconductor products that are compatible with the current RoHS requirements for all 6 substances, including the requirement that lead not exceed 0.1% by weight in homogeneous materials. Where designed to be soldered at high temperatures, TI Pb-Free products are suitable for use in specified lead-free processes.

Pb-Free (RoHS Exempt): This component has a RoHS exemption for either 1) lead-based flip-chip solder bumps used between the die and package, or 2) lead-based die adhesive used between the die and leadframe. The component is otherwise considered Pb-Free (RoHS compatible) as defined above.

Green (RoHS & no Sb/Br): TI defines "Green" to mean Pb-Free (RoHS compatible), and free of Bromine (Br) and Antimony (Sb) based flame retardants (Br or Sb do not exceed 0.1% by weight in homogeneous material)

(3) MSL, Peak Temp. - The Moisture Sensitivity Level rating according to the JEDEC industry standard classifications, and peak solder temperature.

(4) There may be additional marking, which relates to the logo, the lot trace code information, or the environmental category on the device.

(5) Multiple Device Markings will be inside parentheses. Only one Device Marking contained in parentheses and separated by a "-" will appear on a device. If a line is indented then it is a continuation of the previous line and the two combined represent the entire Device Marking for that device.

(6) Lead/Ball Finish - Orderable Devices may have multiple material finish options. Finish options are separated by a vertical ruled line. Lead/Ball Finish values may wrap to two lines if the finish value exceeds the maximum column width.

Important Information and Disclaimer:The information provided on this page represents TI's knowledge and belief as of the date that it is provided. TI bases its knowledge and belief on information provided by third parties, and makes no representation or warranty as to the accuracy of such information. Efforts are underway to better integrate information from third parties. TI has taken and continues to take reasonable steps to provide representative and accurate information but may not have conducted destructive testing or chemical analysis on incoming materials and chemicals. TI and TI suppliers consider certain information to be proprietary, and thus CAS numbers and other limited information may not be available for release.

In no event shall TI's liability arising out of such information exceed the total purchase price of the TI part(s) at issue in this document sold by TI to Customer on an annual basis.

OTHER QUALIFIED VERSIONS OF SN54HC00, SN54HC00-SP, SN74HC00 :

● Catalog: [SN74HC00](#), [SN54HC00](#)

● Automotive: [SN74HC00-Q1](#), [SN74HC00-Q1](#)

- Military: [SN54HC00](#)
- Space: [SN54HC00-SP](#)

NOTE: Qualified Version Definitions:

- Catalog - TI's standard catalog product
- Automotive - Q100 devices qualified for high-reliability automotive applications targeting zero defects
- Military - QML certified for Military and Defense Applications
- Space - Radiation tolerant, ceramic packaging and qualified for use in Space-based application

TAPE AND REEL INFORMATION

QUADRANT ASSIGNMENTS FOR PIN 1 ORIENTATION IN TAPE

*All dimensions are nominal

Device	Package Type	Package Drawing	Pins	SPQ	Reel Diameter (mm)	Reel Width W1 (mm)	A0 (mm)	B0 (mm)	K0 (mm)	P1 (mm)	W (mm)	Pin1 Quadrant
SN74HC00DBR	SSOP	DB	14	2000	330.0	16.4	8.2	6.6	2.5	12.0	16.0	Q1
SN74HC00DR	SOIC	D	14	2500	330.0	16.4	6.5	9.0	2.1	8.0	16.0	Q1
SN74HC00DR	SOIC	D	14	2500	330.0	16.4	6.5	9.0	2.1	8.0	16.0	Q1
SN74HC00DR	SOIC	D	14	2500	330.0	16.8	6.5	9.5	2.3	8.0	16.0	Q1
SN74HC00DRG4	SOIC	D	14	2500	330.0	16.4	6.5	9.0	2.1	8.0	16.0	Q1
SN74HC00DT	SOIC	D	14	250	330.0	16.4	6.5	9.0	2.1	8.0	16.0	Q1
SN74HC00PWR	TSSOP	PW	14	2000	330.0	12.4	6.9	5.6	1.6	8.0	12.0	Q1
SN74HC00PWR	TSSOP	PW	14	2000	330.0	12.4	6.9	5.6	1.6	8.0	12.0	Q1
SN74HC00PWRG4	TSSOP	PW	14	2000	330.0	12.4	6.9	5.6	1.6	8.0	12.0	Q1
SN74HC00PWT	TSSOP	PW	14	250	330.0	12.4	6.9	5.6	1.6	8.0	12.0	Q1

TAPE AND REEL BOX DIMENSIONS

*All dimensions are nominal

Device	Package Type	Package Drawing	Pins	SPQ	Length (mm)	Width (mm)	Height (mm)
SN74HC00DBR	SSOP	DB	14	2000	367.0	367.0	38.0
SN74HC00DR	SOIC	D	14	2500	367.0	367.0	38.0
SN74HC00DR	SOIC	D	14	2500	333.2	345.9	28.6
SN74HC00DR	SOIC	D	14	2500	364.0	364.0	27.0
SN74HC00DRG4	SOIC	D	14	2500	333.2	345.9	28.6
SN74HC00DT	SOIC	D	14	250	367.0	367.0	38.0
SN74HC00PWR	TSSOP	PW	14	2000	364.0	364.0	27.0
SN74HC00PWR	TSSOP	PW	14	2000	367.0	367.0	35.0
SN74HC00PWRG4	TSSOP	PW	14	2000	367.0	367.0	35.0
SN74HC00PWT	TSSOP	PW	14	250	367.0	367.0	35.0

FK (S-CQCC-N**)

LEADLESS CERAMIC CHIP CARRIER

28 TERMINAL SHOWN



NO. OF TERMINALS **	A		B	
	MIN	MAX	MIN	MAX
20	0.342 (8,69)	0.358 (9,09)	0.307 (7,80)	0.358 (9,09)
28	0.442 (11,23)	0.458 (11,63)	0.406 (10,31)	0.458 (11,63)
44	0.640 (16,26)	0.660 (16,76)	0.495 (12,58)	0.560 (14,22)
52	0.740 (18,78)	0.761 (19,32)	0.495 (12,58)	0.560 (14,22)
68	0.938 (23,83)	0.962 (24,43)	0.850 (21,6)	0.858 (21,8)
84	1.141 (28,99)	1.165 (29,59)	1.047 (26,6)	1.063 (27,0)



4040140/D 01/11

- NOTES:
- All linear dimensions are in inches (millimeters).
 - This drawing is subject to change without notice.
 - This package can be hermetically sealed with a metal lid.
 - Falls within JEDEC MS-004

MECHANICAL DATA

NS (R-PDSO-G)**

PLASTIC SMALL-OUTLINE PACKAGE

14-PINS SHOWN



- NOTES:
- All linear dimensions are in millimeters.
 - This drawing is subject to change without notice.
 - Body dimensions do not include mold flash or protrusion, not to exceed 0,15.

W (R-GDFP-F14)

CERAMIC DUAL FLATPACK



4040180-2/F 04/14

- NOTES:
- A. All linear dimensions are in inches (millimeters).
 - B. This drawing is subject to change without notice.
 - C. This package can be hermetically sealed with a ceramic lid using glass frit.
 - D. Index point is provided on cap for terminal identification only.
 - E. Falls within MIL STD 1835 GDFP1-F14

J 14

GENERIC PACKAGE VIEW
CDIP - 5.08 mm max height
CERAMIC DUAL IN LINE PACKAGE



Images above are just a representation of the package family, actual package may vary.
Refer to the product data sheet for package details.

4040083-5/G

J0014A



PACKAGE OUTLINE

CDIP - 5.08 mm max height

CERAMIC DUAL IN LINE PACKAGE



4214771/A 05/2017

NOTES:

1. All controlling linear dimensions are in inches. Dimensions in brackets are in millimeters. Any dimension in brackets or parenthesis are for reference only. Dimensioning and tolerancing per ASME Y14.5M.
2. This drawing is subject to change without notice.
3. This package is hermetically sealed with a ceramic lid using glass frit.
4. Index point is provided on cap for terminal identification only and on press ceramic glass frit seal only.
5. Falls within MIL-STD-1835 and GDIP1-T14.

EXAMPLE BOARD LAYOUT

J0014A

CDIP - 5.08 mm max height

CERAMIC DUAL IN LINE PACKAGE



LAND PATTERN EXAMPLE
NON-SOLDER MASK DEFINED
SCALE: 5X

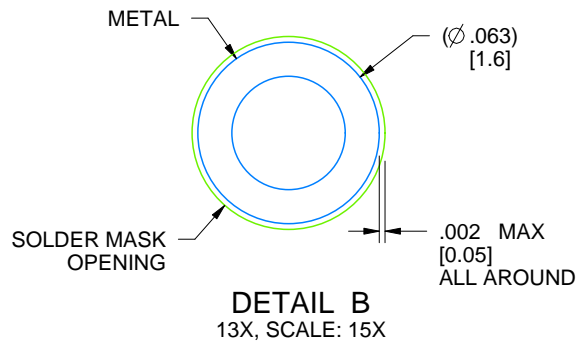

4214771/A 05/2017

D (R-PDSO-G14)

PLASTIC SMALL OUTLINE



- NOTES:
- A. All linear dimensions are in inches (millimeters).
 - B. This drawing is subject to change without notice.
 - $\triangle C$ Body length does not include mold flash, protrusions, or gate burrs. Mold flash, protrusions, or gate burrs shall not exceed 0.006 (0,15) each side.
 - $\triangle D$ Body width does not include interlead flash. Interlead flash shall not exceed 0.017 (0,43) each side.
 - E. Reference JEDEC MS-012 variation AB.

D (R-PDSO-G14)

PLASTIC SMALL OUTLINE



- NOTES:
- A. All linear dimensions are in millimeters.
 - B. This drawing is subject to change without notice.
 - C. Publication IPC-7351 is recommended for alternate designs.
 - D. Laser cutting apertures with trapezoidal walls and also rounding corners will offer better paste release. Customers should contact their board assembly site for stencil design recommendations. Refer to IPC-7525 for other stencil recommendations.
 - E. Customers should contact their board fabrication site for solder mask tolerances between and around signal pads.

PW (R-PDSO-G14)

PLASTIC SMALL OUTLINE



- NOTES:
- A. All linear dimensions are in millimeters. Dimensioning and tolerancing per ASME Y14.5M-1994.
 - B. This drawing is subject to change without notice.
 -  Body length does not include mold flash, protrusions, or gate burrs. Mold flash, protrusions, or gate burrs shall not exceed 0,15 each side.
 -  Body width does not include interlead flash. Interlead flash shall not exceed 0,25 each side.
 - E. Falls within JEDEC MO-153

PW (R-PDSO-G14)

PLASTIC SMALL OUTLINE



4211284-2/G 08/15

- NOTES:
- All linear dimensions are in millimeters.
 - This drawing is subject to change without notice.
 - Publication IPC-7351 is recommended for alternate designs.
 - Laser cutting apertures with trapezoidal walls and also rounding corners will offer better paste release. Customers should contact their board assembly site for stencil design recommendations. Refer to IPC-7525 for other stencil recommendations.
 - Customers should contact their board fabrication site for solder mask tolerances between and around signal pads.

N (R-PDIP-T**)

PLASTIC DUAL-IN-LINE PACKAGE

16 PINS SHOWN



- NOTES:
- A. All linear dimensions are in inches (millimeters).
 - B. This drawing is subject to change without notice.
 - C Falls within JEDEC MS-001, except 18 and 20 pin minimum body length (Dim A).
 - D The 20 pin end lead shoulder width is a vendor option, either half or full width.

4040049/E 12/2002

DB (R-PDSO-G**)

PLASTIC SMALL-OUTLINE

28 PINS SHOWN



- NOTES: A. All linear dimensions are in millimeters.
 B. This drawing is subject to change without notice.
 C. Body dimensions do not include mold flash or protrusion not to exceed 0,15.
 D. Falls within JEDEC MO-150

IMPORTANT NOTICE

Texas Instruments Incorporated (TI) reserves the right to make corrections, enhancements, improvements and other changes to its semiconductor products and services per JESD46, latest issue, and to discontinue any product or service per JESD48, latest issue. Buyers should obtain the latest relevant information before placing orders and should verify that such information is current and complete.

TI's published terms of sale for semiconductor products (<http://www.ti.com/sc/docs/stdterms.htm>) apply to the sale of packaged integrated circuit products that TI has qualified and released to market. Additional terms may apply to the use or sale of other types of TI products and services.

Reproduction of significant portions of TI information in TI data sheets is permissible only if reproduction is without alteration and is accompanied by all associated warranties, conditions, limitations, and notices. TI is not responsible or liable for such reproduced documentation. Information of third parties may be subject to additional restrictions. Resale of TI products or services with statements different from or beyond the parameters stated by TI for that product or service voids all express and any implied warranties for the associated TI product or service and is an unfair and deceptive business practice. TI is not responsible or liable for any such statements.

Buyers and others who are developing systems that incorporate TI products (collectively, "Designers") understand and agree that Designers remain responsible for using their independent analysis, evaluation and judgment in designing their applications and that Designers have full and exclusive responsibility to assure the safety of Designers' applications and compliance of their applications (and of all TI products used in or for Designers' applications) with all applicable regulations, laws and other applicable requirements. Designer represents that, with respect to their applications, Designer has all the necessary expertise to create and implement safeguards that (1) anticipate dangerous consequences of failures, (2) monitor failures and their consequences, and (3) lessen the likelihood of failures that might cause harm and take appropriate actions. Designer agrees that prior to using or distributing any applications that include TI products, Designer will thoroughly test such applications and the functionality of such TI products as used in such applications.

TI's provision of technical, application or other design advice, quality characterization, reliability data or other services or information, including, but not limited to, reference designs and materials relating to evaluation modules, (collectively, "TI Resources") are intended to assist designers who are developing applications that incorporate TI products; by downloading, accessing or using TI Resources in any way, Designer (individually or, if Designer is acting on behalf of a company, Designer's company) agrees to use any particular TI Resource solely for this purpose and subject to the terms of this Notice.

TI's provision of TI Resources does not expand or otherwise alter TI's applicable published warranties or warranty disclaimers for TI products, and no additional obligations or liabilities arise from TI providing such TI Resources. TI reserves the right to make corrections, enhancements, improvements and other changes to its TI Resources. TI has not conducted any testing other than that specifically described in the published documentation for a particular TI Resource.

Designer is authorized to use, copy and modify any individual TI Resource only in connection with the development of applications that include the TI product(s) identified in such TI Resource. NO OTHER LICENSE, EXPRESS OR IMPLIED, BY ESTOPPEL OR OTHERWISE TO ANY OTHER TI INTELLECTUAL PROPERTY RIGHT, AND NO LICENSE TO ANY TECHNOLOGY OR INTELLECTUAL PROPERTY RIGHT OF TI OR ANY THIRD PARTY IS GRANTED HEREIN, including but not limited to any patent right, copyright, mask work right, or other intellectual property right relating to any combination, machine, or process in which TI products or services are used. Information regarding or referencing third-party products or services does not constitute a license to use such products or services, or a warranty or endorsement thereof. Use of TI Resources may require a license from a third party under the patents or other intellectual property of the third party, or a license from TI under the patents or other intellectual property of TI.

TI RESOURCES ARE PROVIDED "AS IS" AND WITH ALL FAULTS. TI DISCLAIMS ALL OTHER WARRANTIES OR REPRESENTATIONS, EXPRESS OR IMPLIED, REGARDING RESOURCES OR USE THEREOF, INCLUDING BUT NOT LIMITED TO ACCURACY OR COMPLETENESS, TITLE, ANY EPIDEMIC FAILURE WARRANTY AND ANY IMPLIED WARRANTIES OF MERCHANTABILITY, FITNESS FOR A PARTICULAR PURPOSE, AND NON-INFRINGEMENT OF ANY THIRD PARTY INTELLECTUAL PROPERTY RIGHTS. TI SHALL NOT BE LIABLE FOR AND SHALL NOT DEFEND OR INDEMNIFY DESIGNER AGAINST ANY CLAIM, INCLUDING BUT NOT LIMITED TO ANY INFRINGEMENT CLAIM THAT RELATES TO OR IS BASED ON ANY COMBINATION OF PRODUCTS EVEN IF DESCRIBED IN TI RESOURCES OR OTHERWISE. IN NO EVENT SHALL TI BE LIABLE FOR ANY ACTUAL, DIRECT, SPECIAL, COLLATERAL, INDIRECT, PUNITIVE, INCIDENTAL, CONSEQUENTIAL OR EXEMPLARY DAMAGES IN CONNECTION WITH OR ARISING OUT OF TI RESOURCES OR USE THEREOF, AND REGARDLESS OF WHETHER TI HAS BEEN ADVISED OF THE POSSIBILITY OF SUCH DAMAGES.

Unless TI has explicitly designated an individual product as meeting the requirements of a particular industry standard (e.g., ISO/TS 16949 and ISO 26262), TI is not responsible for any failure to meet such industry standard requirements.

Where TI specifically promotes products as facilitating functional safety or as compliant with industry functional safety standards, such products are intended to help enable customers to design and create their own applications that meet applicable functional safety standards and requirements. Using products in an application does not by itself establish any safety features in the application. Designers must ensure compliance with safety-related requirements and standards applicable to their applications. Designer may not use any TI products in life-critical medical equipment unless authorized officers of the parties have executed a special contract specifically governing such use. Life-critical medical equipment is medical equipment where failure of such equipment would cause serious bodily injury or death (e.g., life support, pacemakers, defibrillators, heart pumps, neurostimulators, and implantables). Such equipment includes, without limitation, all medical devices identified by the U.S. Food and Drug Administration as Class III devices and equivalent classifications outside the U.S.

TI may expressly designate certain products as completing a particular qualification (e.g., Q100, Military Grade, or Enhanced Product). Designers agree that it has the necessary expertise to select the product with the appropriate qualification designation for their applications and that proper product selection is at Designers' own risk. Designers are solely responsible for compliance with all legal and regulatory requirements in connection with such selection.

Designer will fully indemnify TI and its representatives against any damages, costs, losses, and/or liabilities arising out of Designer's non-compliance with the terms and provisions of this Notice.