

3W, Wide input voltage, isolated & regulated dual / single output DC/DC converter

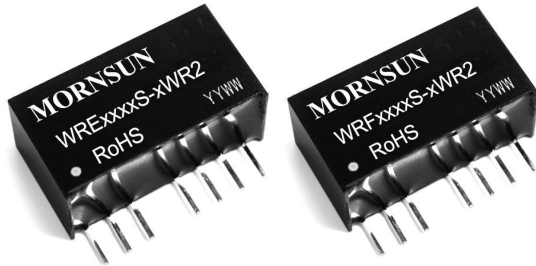

Patent Protection

Report EN62368-1
 Report BS EN62368-1
 CB RoHS IEC62368-1

FEATURES

- Compact SIP package
- Wide input voltage range (2:1)
- Operating temperature range: -40°C to +85°C
- I/O Isolation test voltage 3k VDC
- Short circuit protection (self-recovery)
- High power density
- Remote On/Off
- Meets EN60950 standards

WRE_S-3WR2 & WRF_S-3WR2 series are isolated 3W DC-DC converter products with a wide 2:1 input voltage range and input isolation is tested with 3000VDC. The product has a relatively compact SIP plastic package, and features high efficiency, operating temperature of -40°C to +85 °C. The smaller size and fine cost design make the converter an ideal solution in communication, instruments, and industrial electronics applications.

Selection Guide

Certification	Part No.	Input Voltage (VDC)		Output		Ripple&noise (mVp-p) Typ./Max.	Full Load Efficiency (%) Min./Typ.	Capacitive Load ^② (μF)Max.	
		Nominal (Range)	Max. ^①	Voltage(VDC)	Current(mA) Max./Min.				
EN	WRE0505S-3WR2	5 (4.5-9)	11	±5	±250/±13	40/75	72/74	1000	
	WRE0512S-3WR2			±12	±104/±5		75/77	470	
	WRE0515S-3WR2			±15	±83/±4		75/77	330	
	WRF0505S-3WR2			5	500/25		71/73	2200	
	WRF0509S-3WR2			9	278/14		72/74	1000	
	WRF0512S-3WR2			12	208/10		75/77	680	
	WRF0515S-3WR2	15	167/8	72/74	470				
	WRE1205S-3WR2	12 (9-18)	20	±5	±300/±15	70/100	76/78	1000	
	WRE1212S-3WR2			±12	±125/±6		77/79	470	
	WRE1215S-3WR2			±15	±100/±5		78/80	330	
	WRF1203S-3WR2			3.3	758/38		73/75	2700	
	WRF1205S-3WR2			5	600/30		74/76	2200	
	WRF1209S-3WR2			9	333/17		77/79	1000	
	WRF1212S-3WR2	12	250/13	100/150	80/82	680			
	WRF1215S-3WR2	15	200/10		81/83	470			
	WRF1224S-3WR2	24	125/6		79/81	330			
	WRE2405S-3WR2	24 (18-36)	40		±5	±300/±15	40/75	77/79	1000
	WRE2409S-3WR2				±9	±167/±8		79/81	680
WRE2412S-3WR2	±12				±125/±6	81/83		470	
WRE2415S-3WR2	±15			±100/±5	81/83	330			
WRF2403S-3WR2	3.3			758/38	72/74	2700			
WRF2405S-3WR2	5			600/30	79/81	2200			
EN/IEC	WRF2409S-3WR2	9	333/17	100/150	81/83	1000			
	WRF2412S-3WR2	12	250/13		81/83	680			
	WRF2415S-3WR2	15	200/10		81/83	470			
	WRF2424S-3WR2	24	125/6		81/83	330			
	WRE4805S-3WR2	48 (36-75)	80		±5	±300/±15	40/75	77/79	1000
	WRE4812S-3WR2				±12	±125/±6		80/82	470
WRE4815S-3WR2	±15			±100/±5	80/82	330			

EN	WRF4803S-3WR2	48 (36-75)	80	3.3	758/38	100/150	73/75	2700
EN/BS EN	WRF4805S-3WR2			5	600/30	40/75	74/76	2200
	WRF4812S-3WR2			12	250/13		78/80	680
	WRF4815S-3WR2			15	200/10	70/100	82/84	470

Notes:

- ① Exceeding the maximum input voltage may cause permanent damage;
- ② For the dual output modules, the capacitive loads of positive and negative outputs are the same.

Input Specifications

Item	Operating Conditions	Min.	Typ.	Max.	Unit	
Input Current (full load/no-load)	5VDC Input	--	800/60	846/65	mA	
	12VDC Input	3.3V Output	--	277/25		286/30
		Others	--	314/25		338/30
	24VDC Input	3.3V Output	--	140/8		145/13
		Others	--	154/8		163/13
	48VDC Input	3.3V Output	--	69/3		72/10
		Others	--	78/3		85/10
	Reflected Ripple Current	5VDC Input	--	20		--
12VDC Input		--	20	--		
24VDC Input		--	55	--		
48VDC Input		--	55	--		
Surge Voltage (1sec. max.)	5VDC Input	-0.7	--	12	VDC	
	12VDC Input	-0.7	--	25		
	24VDC Input	-0.7	--	50		
	48VDC Input	-0.7	--	100		
Starting Voltage	5VDC Input	3.5	4	4.5	VDC	
	12VDC Input	4.5	8	9		
	24VDC Input	11	16	18		
	48VDC Input	24	33	36		
Input Filter		Filter capacitor				
Hot Plug		Unavailable				
Ctrl *	Module turn-on	The Ctrl end is suspended or of high resistance				
	Module turn-off	Connect with high level (relative to the input grounding) to make the 5-10mA current flows into the Ctrl end.				

Note: * For use of Ctrl, please refer to the "design reference" in this manual.

Output Specifications

Item	Operating Conditions	Min.	Typ.	Max.	Unit
Output Voltage Accuracy ^①	5%-100% load	--	±1	±3	%
Line Regulation ^②	Full load, the input voltage is from low to high	--	±0.2	±0.5	
Load Regulation	5%-100% load	--	±0.4	±0.75	
Transient Recovery Time	25% load step change	--	0.5	3	ms
Transient Response Deviation		--	±2.5	±5	%
Temperature Coefficient	Full load	--	±0.02	±0.03	%/°C
Ripple & Noise ^③	20MHz bandwidth	See Selection Guide			
Short Circuit Protection		Continuous, self-recovery			

Note:

- ① Under the of 5%-100% load, the maximum output voltage accuracy of WRE2405S-3WR2 auxiliary circuit is ±4%;
- ② Linear Regulation for 100% load, WRE2405S-3WR2 increases to ±1%;
- ③ Ripple and noise are measured by "parallel cable" method, please see DC-DC Converter Application Notes for specific operation. The WRE2405S-3WR2 ripple maximum is 65 mVp-p.

General Specifications

Item	Operating Conditions	Min.	Typ.	Max.	Unit
Insulation Voltage	Input-output, with the test time of 1 minute and the leak current lower than 1mA	3000	--	--	VDC
Insulation Resistance	Input-output, isolation voltage 500VDC	1000	--	--	MΩ
Isolation Capacitance	Input-output, 100kHz/0.1V	--	30	50	pF
Operating Temperature	see Fig. 1	-40	--	+85	°C
Storage Temperature		-55	--	+125	
Casing Temperature Rise	Ta=25°C, nominal input, full load output	--	+25	--	
Pin Welding Resistance Temperature	Welding spot is 1.5mm away from the casing, 10 seconds	--	--	+300	
Storage Humidity	Non-condensing	--	--	95	%RH
Switching Frequency (PFM Mode)	Full load, nominal input voltage	--	250	--	kHz
MTBF	MIL-HDBK-217F@25°C	1000	--	--	k hours

Physical Specifications

Casing Material	Black flame-retardant and heat-resistant plastic
Dimension	22.00 x 9.50 x 12.00 mm
Weight	4.9g(Typ.)
Cooling Method	Free air convection

EMC Specifications

EMI	CE	CISPR32/EN55032	CLASS B (see Fig. 3-② for recommended circuit)	
	RE	CISPR32/EN55032	CLASS B (see Fig. 3-② for recommended circuit)	
EMS	ESD	IEC/EN61000-4-2	Contact ±4kV	perf. Criteria B
	RS	IEC/EN61000-4-3	10V/m	perf. Criteria A
	EFT	IEC/EN61000-4-4	±2kV (see Fig. 3-① for recommended circuit)	perf. Criteria B
	Surge	IEC/EN61000-4-5	line to line ±2kV (see Fig. 3-① for recommended circuit)	perf. Criteria B
	CS	IEC/EN61000-4-6	3 Vr.m.s	perf. Criteria A
	Voltage dips, short interruptions and voltage variations immunity	IEC/EN61000-4-29	0%, 70%	perf. Criteria B

Product Characteristic Curve

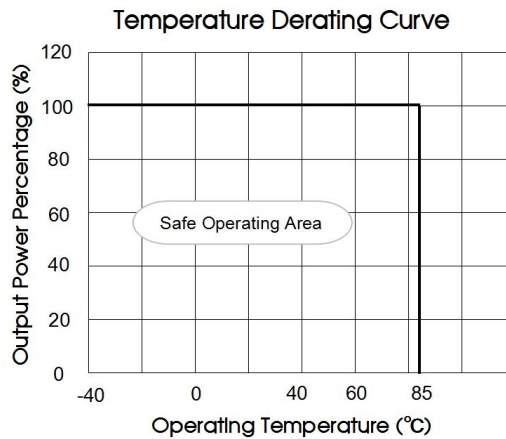
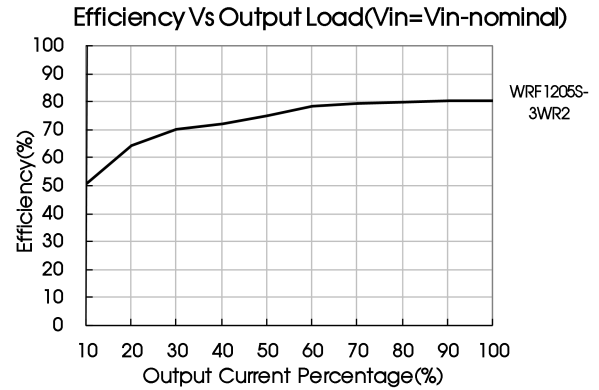
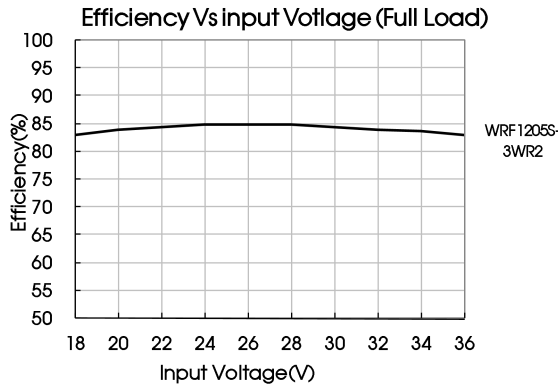
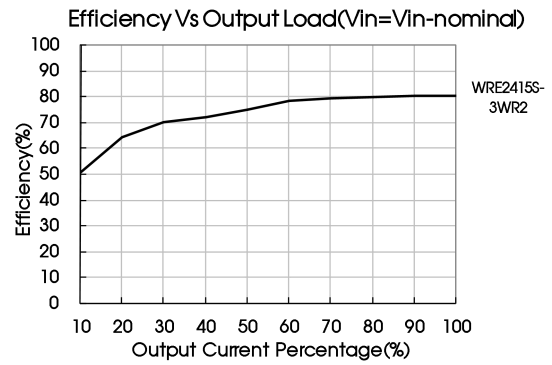
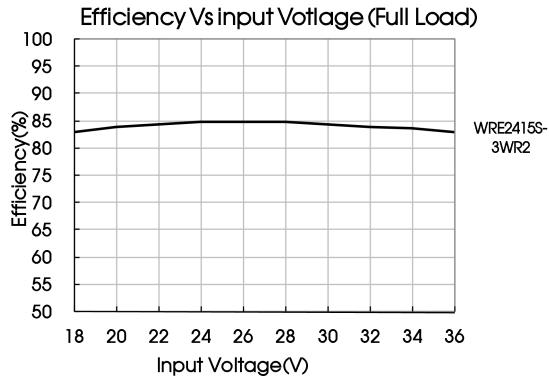

Fig 1



Design Reference

1. Recommended circuit

All the DC/DC converters of this series are tested according to the recommended circuit (see Fig. 2) before delivery.

If a further decrease of the input and output ripple is required, properly increase the input & output of additional capacitors Cin1, Cin2, Cs and Cout; or select capacitors of low equivalent impedance like series capacitor, etc. Cs is used to reduce ripple. No need to add Cs, if ripple meets the demand. Appropriate filter capacitance shall be chosen, start-up problems may be caused if the capacitance is too large. For each output circuit, under the condition of safe and reliable operation, the max. capacity of its filter capacitor should be lower than the max. capacitive load.

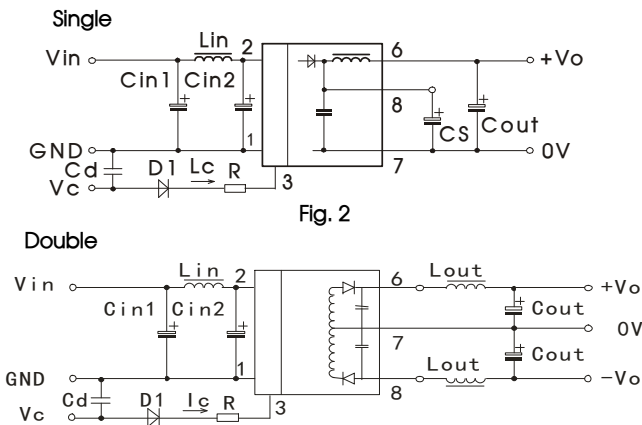

Vin	5VDC&12VDC	24VDC&48VDC
Cin1	100μF/25VDC	10μF/100VDC
Cin2	47μF/25VDC	1μF/100VDC
Lin	4.7μH-12μH	
Cs	10μF-22μF/50VDC	
Cout	100μF/50VDC(Typ.)	
Cd	47nF/100V	

2. EMC solution-recommended circuit

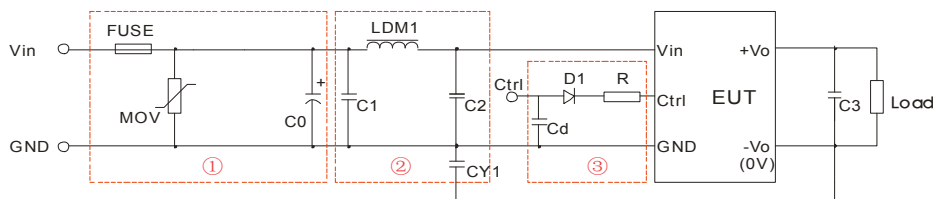

Fig. 3

Parameter description:

Model	Vin: 5VDC	Vin: 12VDC	Vin: 24VDC	Vin: 48VDC
FUSE	Selecting based on needs			
MOV	--	S14K20	S20K30	S14K60
LDM1	12 μ H	12 μ H	12 μ H	12 μ H
C0	680μF/25V		330μF/50V	330μF/100V
C1	4.7μF/50V			4.7μF/100V
C2	4.7μF/50V			4.7μF/100V
C3	Refer to the Cout in Fig.2			
CY1	1nF/3kV			
D1	RB160M-60V/1A			
R	In accordance with the formula: $R = \frac{V_C - V_D - 1.0}{I_C} - 300$			
Cd	47nF/100V			

Notes:

- ① Part ① in Fig. 3 is used for EMS test while part ② is used for EMI filtering; and parts ① and ② may be selected based on needs.
- ② V_C is the voltage of the Ctrl end relative to the GND of the input grounding; V_D is the positive-going conduction pressure drop of D1; I_C is the current flows into the Ctrl end and its value is generally 5-10mA, see Fig. 3-③ for the peripheral circuit of Ctrl end;
- ③ If there is no recommended parameters, no external component is required.

3. Ctrl end

The modules are of normal output when the Ctrl end is suspended or of high resistance; the modules turn off when connecting with high level (relative to the input grounding); notice that the current flows into the pin shall be 5 - 10mA, the modules will be permanently damaged if the current exceeds its max. value (20mA in general).

The value of R can be derived as follows:

$$R = \frac{V_C - V_D - 1.0}{I_C} - 300$$

For Detailed parameter, please refer to EMC solution-recommended circuit in this manual.

4. Input current

When the electricity is provided by the unstable power supply, please make sure that the range of the output voltage fluctuation and the ripple voltage of the power supply do not exceed the indicators of the modules. Input current of power supply should afford the flash startup current of this kind of DC/DC module(see Fig. 5).

Generally: Vin= 5V series Iave =1315mA
 Vin=12V series Iave =631mA
 Vin=24V series Iave =303mA
 Vin=48V series Iave =158mA

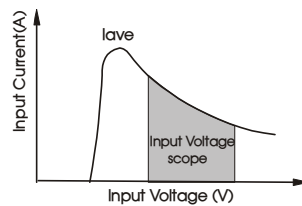

Fig. 5

5. Output load requirements

When using, the minimum load of the module output should not be less than 5% of the nominal load. In order to meet the performance parameters of this datasheet, please connect a 5% dummy load in parallel at the output end, the dummy load is generally a resistor, please note that the resistor needs to be used in derating.

6. For more information please find DC-DC converter application notes on www.mornsun-power.com

Dimensions and Recommended Layout

THIRD ANGLE PROJECTION 

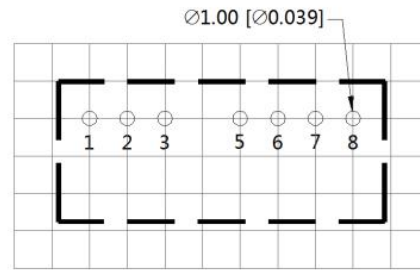
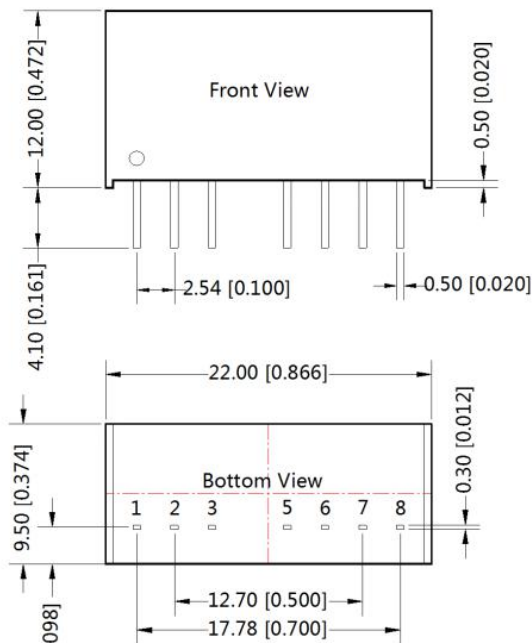

Note: Grid 2.54*2.54mm

Pin-Out		
Pin	Single	Dual
1	GND	GND
2	Vin	Vin
3	Ctrl	Ctrl
5	NC	NC
6	+Vo	+Vo
7	0V	0V
8	CS	-Vo

NC: No connection

Note:
Unit: mm[inch]
Pin section tolerances: $\pm 0.10[\pm 0.004]$
General tolerances: $\pm 0.25[\pm 0.010]$

Notes:

1. Packing information please refer to Product Packing Information which can be downloaded from www.mornsun-power.com. Packing bag number: 58210004;
2. Recommend to use module with more than 5% load, if not, the ripple of the product may exceeds the specification, but does not affect the reliability of the product;
3. The recommended unbalance degree of the dual output module load is $\leq \pm 5\%$; if the degree exceeds $\pm 5\%$, than the product performance cannot be guaranteed to comply with all parameters in the datasheet. Please contact our technicians directly for specific information;
4. The maximum capacitive load offered were tested at input voltage range and full load;
5. Unless otherwise specified, parameters in this datasheet were measured under the conditions of $T_a=25^\circ\text{C}$, humidity $<75\%$ RH with nominal input voltage and rated output load;
6. All index testing methods in this datasheet are based on company corporate standards;
7. We can provide product customization service, please contact our technicians directly for specific information;
8. Specifications are subject to change without prior notice.

Mornsun Guangzhou Science & Technology Co., Ltd.

Address: No. 8, Nanyun 4th Road, Huangpu District, Guangzhou, China
Tel: 86-20-38601850

Fax: 86-20-38601272

E-mail: info@mornsun.cn

www.mornsun-power.com