

产品承认书

SPECIFICATION FOR APPROVAL

客 户 (Customer): 000 WEST-OST

规 格 (Description): DC Brushless Fan

型 号 (Model No.): YDM6025C12F

样品编号 (Sample No.): 20200929001-2

送样日期 (Sample Date):

客户承认栏 CUSTOMER APPROVAL			
	核 准 APPROVED	审 核 CHECKED	制 表 DRAWN
感谢选择 YCCFAN 产品, 若样品符合贵司的要求, 劳烦将此承认书签章回传到敝司。 Thanks for choosing YCCFAN products. Please sign and return this approval sheet to us after confirming the data.	赖勇文	陆元林	雷雪琳

深圳市永诚创科技有限公司

SHENZHEN YCCFAN TECHNOLOGY CO., LTD.

永诚创国际(香港)有限公司

YCCFAN INTERNATIONAL (HK) LIMITED

地址: 深圳市宝安区福海街道建安路 22 号

ADD: No.22 Jianan Rd, Fuyong Town, Baoan District, Shenzhen, China. 518100

TEL: 0755-29887126/27/35/36

FAX: 0755-29887129

E-MAIL: yccfan@yccfan.com

HTTP: www.yccfan.com

规格说明书 SPECIFICATION			
			(AT Ta= 25 Degree.)
项目/ITEMS	单位/UNIT	参数/PARAMETERS	备注/NOTES
尺寸/Dimension	mm	60*60*25	Length* Width *Thickness
外框/Fan Frame	----	BLACK PBT (UL94V-0)	Glass Fiber Reinforced
扇叶/Fan Impeller	----	BLACK PBT (UL94V-0)	7 Blade
轴承种类/Bearing System	<input type="checkbox"/> S:Sleeve Bearing <input type="checkbox"/> S:Hypro Bearing <input checked="" type="checkbox"/> C:CycleSeal Bearing <input type="checkbox"/> B:Dual Ball Bearing		
额定电压/Rated Voltage	VDC	12.0	N/A
工作电压范围 Operating Voltage Range	VDC	10.8-13.2	N/A
起动电压/Start-up Voltage	VDC	9.0	N/A
额定电流/Rated Current	Amp	0.19(MAX:0.29)	At 25°C/Relative Humidity 65% At rated Voltage,Measured after 3Mins.
标签电流/Label Current	Amp	0.20	N/A
额定功率/Rated Power	Watt	2.28(MAX:3.48)	At 25°C/Relative Humidity 65% At rated Voltage,Measured after 3Mins
额定转速/Rated Speed	RPM	5000±10%	At 25°C/Relative Humidity 65% At rated Voltage,Measured after 3Mins
风量/Air Flow	CFM	25.47(MIN:22.92)	Maximum In Free Air,Refer to 4.2.
风压/Air Pressure	mmAq	5.62(MIN:4.55)	Maximum When Air Flow = 0
噪音/Noise Level	dBA	37.7(MAX:40.7)	At Rated Speed,Refer to 4.3.
马达保护/Motor Protection	Polarity Protection	Yes	
锁机保护/Locked Motor Protection	Auto Restart	Yes	Refer to 8.2.
缓启动/Soft Start	----	No	N/A
速度感应/FG Sensor	Tachometer Sensor	No	Refer to 2.1.
锁机报警/RD Alarm	Locked Motor Alarm	No	Refer to 2.1.
调速控制/PWM Control	----	No	Refer to 2.2.
防水等级/Waterproof Class	<input type="checkbox"/> IP44	Motor or PCBa Coating by Insulating Paint	
	<input type="checkbox"/> IP55	Motor NT Vacuum Coating or PCBa Coating by Waterproof Glue	
	<input type="checkbox"/> IP56以上	Motor Coating by Epoxy Waterproof Glue or Injection by Mould	
环保要求/Conform to RoHS	----	Yes	Refer to 6.
安规规格/Safety Approval	----	<input checked="" type="checkbox"/> UL <input checked="" type="checkbox"/> CUL <input checked="" type="checkbox"/> CE <input checked="" type="checkbox"/> TUV	
导线/Lead Wire	UL 1007//24AWGx250mm	<input checked="" type="checkbox"/> Red(+) <input checked="" type="checkbox"/> Black(-) <input type="checkbox"/> Yellow(FG) <input type="checkbox"/> White(RD) <input type="checkbox"/> Blue(PWM)	
端子/Connector	----	No	----
套管/Tube	----	No	----
预估寿命/Life Expectancy	小时/Hours	70000	Refer to 7.
净重/Net Weight	克/Gram	56.7	N/A
装箱/Packing	件/箱/Pieces/Carton	200	N/A

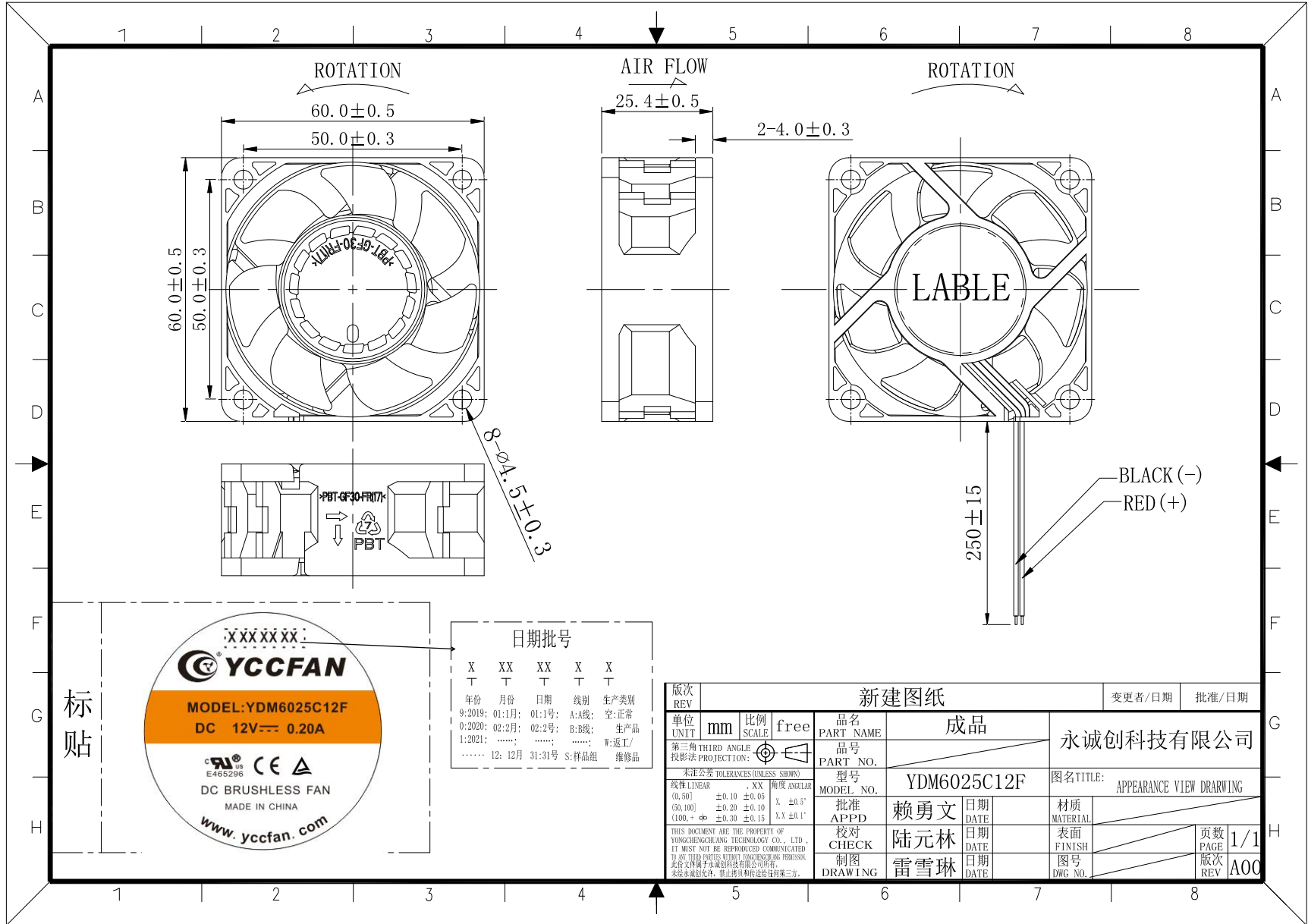

版次 REV	新建图纸				变更者/日期	批准/日期
单位 UNIT	mm	比例 SCALE	free	品名 PART NAME	成品	永诚创科技有限公司
第三角 投影法 THIRD ANGLE PROJECTION			品号 PART NO.	YDM6025C12F		
未注公差 TOLERANCES (UNLESS SHOWN)	线性 LINEAR .XX (0,50) $\pm 0.10 \pm 0.05$ (50,100) $\pm 0.20 \pm 0.10$ (100, ∞) $\pm 0.30 \pm 0.15$		型号 MODEL NO.	批准 APPD	日期 DATE	图名 TITLE: APPEARANCE VIEW DRAWING
THIS DOCUMENT ARE THE PROPERTY OF YONGCHENGCHANG TECHNOLOGY CO., LTD. IT MUST NOT BE REPRODUCED OR COMMUNICATED TO ANY THIRD PARTIES WITHOUT YONGCHENGCHANG TECHNOLOGY CO., LTD.'S WRITTEN PERMISSION. 此份文件属于永诚创科技有限公司所有。 未经永诚创许可，禁止拷贝和传送给任何第三方。			校对 CHECK	日期 DATE	表面 FINISH	页数 PAGE
			制图 DRAWING	日期 DATE	图号 DRG. NO.	1/1
			赖勇文	日期 DATE	材质 MATERIAL	版次 REV
			陆元林	日期 DATE	表面 FINISH	A00
			雷雪琳	日期 DATE	图号 DRG. NO.	

1. 一般规格 General Specification

一般规格参见第 3 页 Refer to page 3

2. 功能介绍 Function Instruction

2.1. 信号输出 Signal Output

2.1.1. 接线说明 (FG/RD) Connection Instruction(FG/RD)

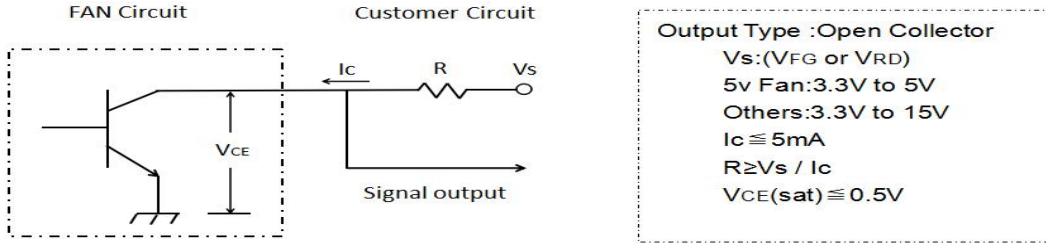

2.1.2. 输出波形 Output Waveform

2.1.2.1 方形信号 Tachometer Sensor(FG)

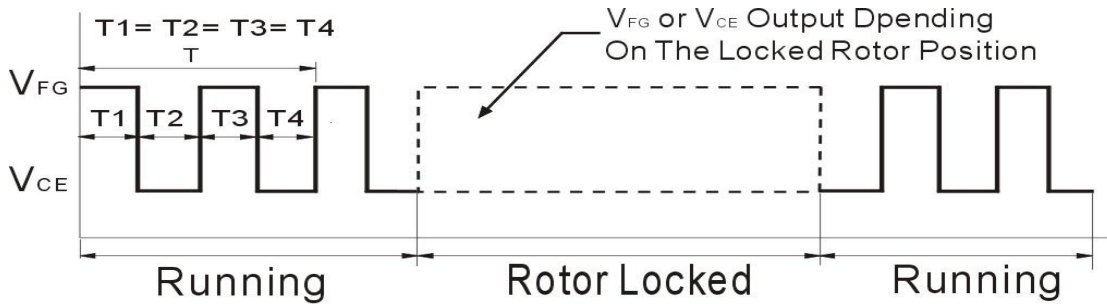

For 4 Poles Motor: $N=R.P.M$ $T= 60/N$ (Sec.) $FG=1/T*2$ (HZ) $N=FG*30$

2.1.2.2. 锁机报警 Locked Motor Alarm (RD)

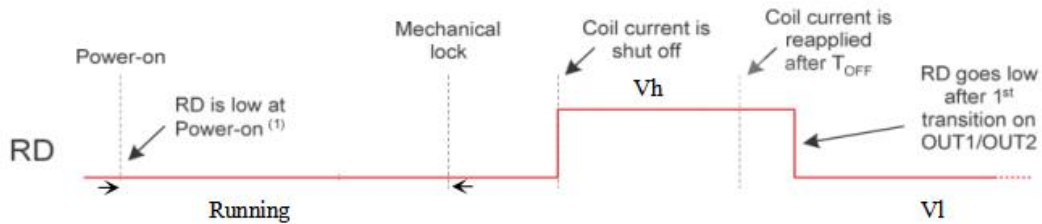

2.2. 速度控制 Speed Control(PWM)

PWM INPUT SIGNAL SEPCIFICATION

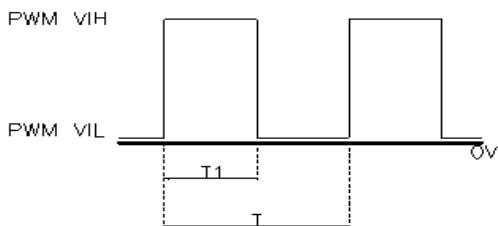

$PWM \text{ DUTY CYCLE}(\%) = \frac{T1}{T} \times 100\%$
 PWM FREQUENCY RANGE 20K~30KHZ
 PWM VIH = 2.8V TO 5.5V
 PWM VIL = 0V TO 0.6V

3. 电气特性 Electrical characteristics

3.1. 绝缘阻抗 Insulation resistance

框与导线正极端子之间加直流 500VDC，最小 10MΩ；
Min 10M ohm between frame and positive terminal at 500VDC.

3.2. 绝缘耐压 Dielectric strength

框与导线正极端子之间加交流 500VAC/60Hz，1 分钟测定漏电流最大 5 mA；
Max.5 mA between frame and positive terminal at 500VAC/60Hz for 1 minute.

3.3. 绝缘类型 Insulated Type

UL: Class A (105°C)

4. 机械特性 Mechanical Characteristics

4.1. 旋转方向 Rotation

参见第 4 页图纸所示 Refer to Page 4 Rotation

4.2. 风量风压曲线 Performance Curve

测试条件 Test Conditions: (1).Rated Voltage;(2).Room Temperature,65%Humidity;

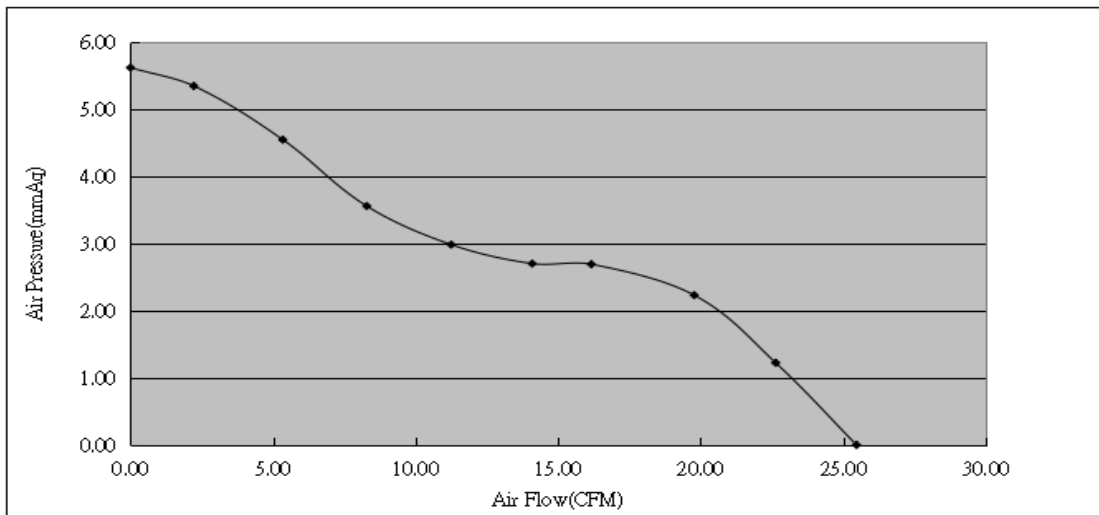

4.3 噪音 Noise Measure

4.3.1. 参照标准 ISO3745/GB4214-84，背景噪音 10±2dBa，室内环境下测量；

According to Standard ISO3745/GB4214-84, Back ground noise 10±2dBa with room condition;

4.3.2. 测试方法 Measure Condition:

风扇悬吊在无响室内，在额定电压下，麦克风距风扇进风口 1 米距离测试；

Fan is hanged in anechoic chamber, measured at rated voltage, measure microphone at a distance of one meter from the fan air intake;

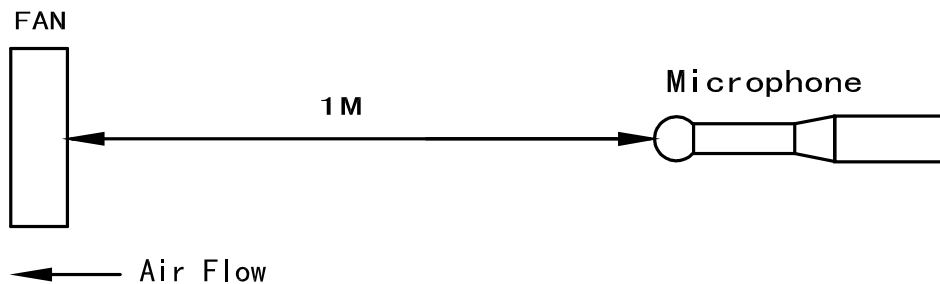

5. 环境适应 Environmental

5.1.运转温度 Operating Temperature	-----	-10 ~ +70 °C
5.2.储存温度 Storage Temperature	-----	-40 ~ +75 °C
5.3.运转湿度 Operating Humidity	-----	35% ~ 85%RH
5.4.储存湿度 Storage Humidity	-----	35% ~ 85%RH

6. 环保要求 RoHS Compliance

产品有害物质的含量符合 RoHS 最新版本的要求;
Product is in compliance with RoHS latest version requirement;

7. 预期寿命 Life Expectancy

- 7.1. Conditions: At Confidence Level 90%; Rated Voltage; 65% Humidity Environment
- 7.2. S: Sleeve Bearing System: 30000 Hours At 25°C Environment
- S: Hypro Bearing System: 30000 Hours At 40°C Environment
- C: CycleSeal Bearing System: 50000 Hours At 40°C Environment
- B: Dual Ball Bearing System: 70000 Hours At 40°C Environment

8. 马达保护 Motor Protection

8.1. 极性保护 Polarity Protection

如果产品的正负极电源线接反，产品能够承受 10 分钟不被损坏;
Be capable of withstanding 10 minutes will not cause damage if reverse connection for positive and negative lead wires;

8.2. 马达锁住保护 Locked Rotor Protection

在正常操作电压和温度范围下，当转子被锁住后，电路电流会被关闭或维持很小范围保护马达在 72 小时内不会损坏;
The current will be shut down or remain a little range to protect motor from damaged in 72 hours when locking rotor at operation voltage and temperature range;

9 安全批准 Safety Approvals

参见第三页 Refer to page 3

风扇安装说明 Fan Installation Instructions:

1. 采用螺栓螺母紧固件时，底盘配合面平整度应保持在 0.1mm 以下。
In case of using bolt-nut fasteners, the flatness of chassis mating surfaces should be kept below 0.1mm.
2. 如何固定不同类型的框架 How to fasten the frames including different types:
 - A. 非包柱式（法兰式）：从入口或出口将螺栓和螺母拧在一起，扭矩不应超过 4.5 kgf cm [图 (a, c)]
Flange type : Screw the bolt and nut together from the inlet or outlet. The torque should not be exceeded 4.5 kgf-cm [figure(a,c)]
 - B. 包柱式（连柱型或肋型）：将螺栓穿过肋。扭矩不应超过 7.5 kgf cm [图 (b,d)]
Rib type : Screw the bolt through the rib. The torque should not be exceeded 7.5 kgf-cm [figure(b,d)]
3. 如果使用自攻螺钉，应使用符合 JIS B 1122 第 2 类的适当螺钉。推荐的自攻螺钉的尺寸详情见表 (a)。每个紧固件孔只能拧紧一次，否则会发生滑动。此外，施加在自攻螺钉上的扭矩不得超过表 (a) 中规定的值。
In case of using self-tapping screws, appropriate screws according to JIS B 1122 Type 2 should be used. The dimensional details of the self-tapping screws recommended are shown in Table(a). Each fastener hole should only be tightened once or slippage may occur. In addition, the torque to be applied to the self-tapping screws must not exceed the values stated in Table(a).
4. 紧固件头部的埋头部分不应干扰框架，否则会有断裂的风险 [图 (e)]。建议使用内表面平坦的紧固件头，即无埋头。
The countersunk part of fastener head should not interfere with the frame or there would be a risk of breakage [figure(e)]. Fastener head with flat inner surface, i.e. no countersunk, is recommended.
5. 在组装过程中不可强拉导线。如 (图 g) 所示 could not pull the wire strongly in assembly process. As shown in (Fig. g)
6. 在组装过程中不可按压叶轮如 (图 h) 所示 Could not press the impeller's fringe in assembly process. As shown in (Fig. h)

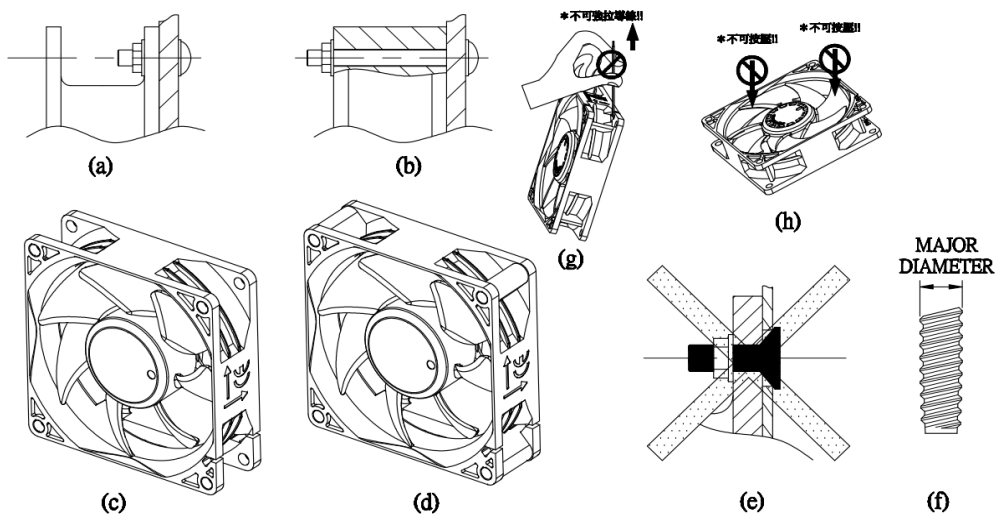

Table A

MOUNTING HOLE DIAMETER	SCRE WSPE C.	MAJOR DIAMETER[Fig.(f)]		*RECOMMENDED MAX. TORQUE (kgf-cm)	
		MAXIMUM	MINIMUM	FLANGE TYPE FRAME	RIB TYPE FRAME
Ø3.5	M4	4.0	3.85	4.5	7.5
Ø4.3	M4.8	4.8	4.65	5.5	7.5
Ø4.5	M5	5.0	4.85	5.5	7.5

*A lower torque than the recommended value should be used if slippage is observed.

注意事项/Notes:

- 我们提供的产品应在规格书指定的条件内使用，如果您的应用超出规格极限，我们对此不保证产品质量。
Our products should be used within the specification appointed condition, so we will not guarantee this product quality if your application exceeds the limitations outlined in this specification.
- 除非事先通知我们所需求参数，否则出货产品与此份规格书一致，未在此份规格书中指定的参数与贵公司最终承认的样品相同。
Product will be shipped in accordance with this specification unless we has been previously notified of parameters requiring exception, if parameters which are not specified in this specification.
- 建议安装风扇保护罩，以免对人员造成意外伤害。
Please use fan guards to avoid personal accidental injuries.
- 除非 IP 等级中有特殊说明，否则该款风扇只能在正常环境下操作。
Unless this fan motor is specified for use in abnormal environments designated by IP rating level, this fan is designed to operate under normal environmental conditions.
- 请避免将风扇接触有毒物质 如：（有机物、氰、福尔马林、苯酚等）。以及在腐蚀性气体环境中使用 如：（硫化氢、二氧化硫、二氧化氮等）。
Please avoid operating FAN's products in poisonous material(organic, cyanogens, formalin, phenol, etc.)or corrosive gas environment(H2S, SO2, NO2,etc.)
- 当风扇在灰尘环境中使用时，请在风扇进风口处安装过滤装置以延长风扇使用寿命。Please use filters to clean the air-intake in very dusty air environments for extended fan life.
- 请确保风扇在规定的温湿度储存环境中，如果风扇存储 6 个月以上，我们建议客户对风扇功能进行评估后并且功能测试后再使用,如果评估时不确定，请找我司确认。
Always ensure that fans are stored according to the storage temperatures specified. Do not store in a high temperatures and humidity environment. If the fans are stored for more than 6 months, we recommend evaluating then functional testing before using,Contact YCC for confirmation if you can't ensure that.
- 确定在连接和断开连接器之前关掉电源，避免产生电子零件损坏。
Make sure to turn off the power before connecting or disconnecting the connectors in case of damaging to electronic parts.