



DC COMPONENTS CO., LTD.

RECTIFIER SPECIALISTS

**KBPC
35005(W)
THRU
KBPC
3510(W)**

TECHNICAL SPECIFICATIONS OF SINGLE-PHASE SILICON BRIDGE RECTIFIER

VOLTAGE RANGE - 50 to 1000 Volts

CURRENT - 35 Amperes

FEATURES

- * Metal case for maximum heat dissipation
- * Low forward voltage drop
- * High current capability

MECHANICAL DATA

- * Case: Molded plastic
- * Epoxy: UL 94-V0 rated flame retardant
- * Lead: MIL-STD-202E, Method 208 guaranteed
- * Polarity: Symbols molded or marked on body
- * Mounting position: Any
- * Weight: 30 grams

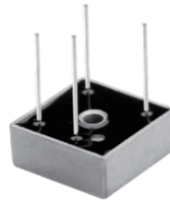

MB-25W



MB-25

MAXIMUM RATINGS AND ELECTRICAL CHARACTERISTICS

Ratings at 25°C ambient temperature unless otherwise specified.
Single phase, half wave, 60Hz, resistive or inductive load.
For capacitive load, derate current by 20%.

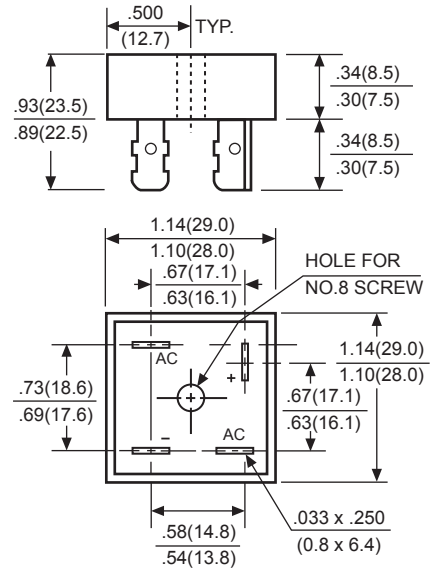
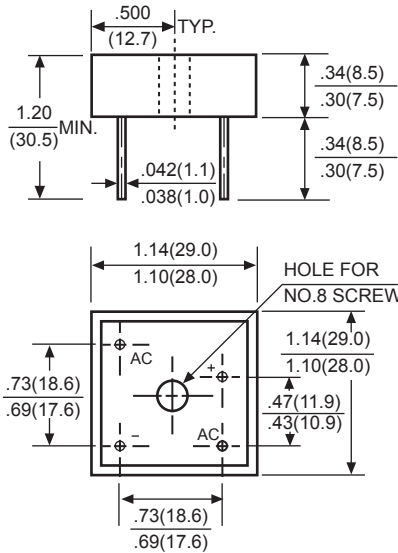

Dimensions in inches and (millimeters)

	SYMBOL	KBPC 35005(W)	KBPC 3501(W)	KBPC 3502(W)	KBPC 3504(W)	KBPC 3506(W)	KBPC 3508(W)	KBPC 3510(W)	UNITS
Maximum Recurrent Peak Reverse Voltage	V _{RRM}	50	100	200	400	600	800	1000	Volts
Maximum RMS Voltage	V _{RMS}	35	70	140	280	420	560	700	Volts
Maximum DC Blocking Voltage	V _{DC}	50	100	200	400	600	800	1000	Volts
Maximum Average Forward Rectified Current at T _A = 55°C	I _O	35							Amps
Peak Forward Surge Current 8.3 ms single half sine-wave superimposed on rated load (JEDEC Method)	I _{FSM}	400							Amps
Maximum Instantaneous Forward Voltage at 17.5A DC	V _F	1.1							Volts
Maximum DC Reverse Current at Rated DC Blocking Voltage	I _R	@T _A = 25°C							μAmps
		@T _A = 125°C							
I ² t Rating for Fusing (t<8.3ms)	I ² t	664							A ² s
Operating and Storage Temperature Range	T _J , T _{STG}	-55 to +150							°C

Note: Suffix "**W**" for wire lead type (e.g.:KBPC35005**W**,KBPC3501**W**...etc)

RATING AND CHARACTERISTIC CURVES (KBPC35005(W) THRU KBPC3510(W))

FIG. 1
TYPICAL FORWARD CURRENT
DERATING CURVE

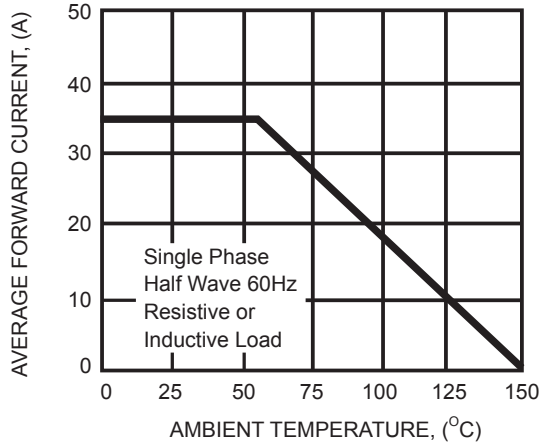

FIG. 2
MAXIMUM NON-REPETITIVE FORWARD
SURGE CURRENT

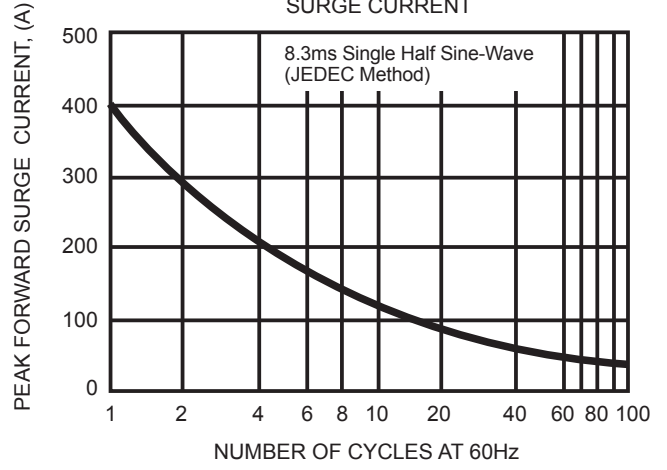

FIG. 3
TYPICAL INSTANTANEOUS
FORWARD CHARACTERISTICS

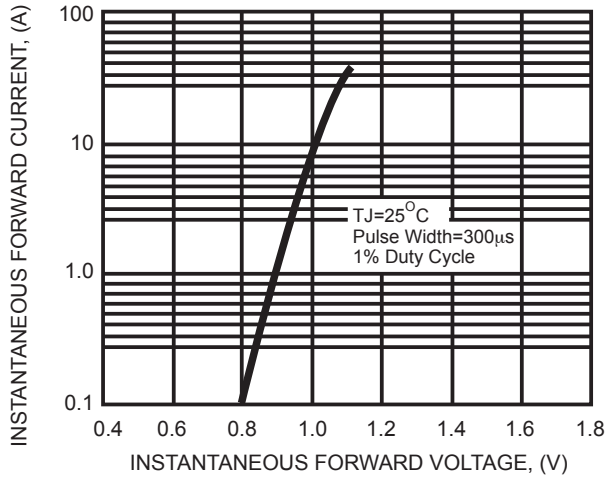
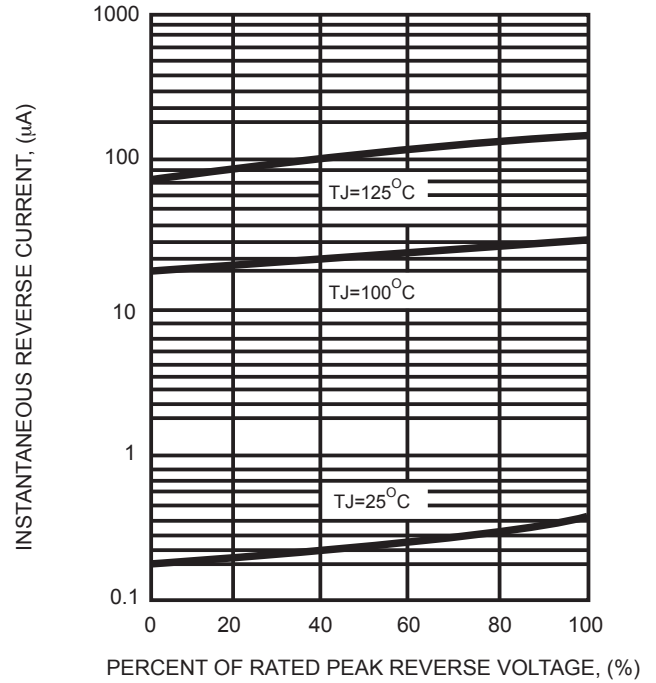

FIG. 4
TYPICAL REVERSE CHARACTERISTICS



Disclaimer

Any Customer or user of this document or products described herein in such applications shall assume all risks of such use and will agree to hold **DC COMPONENTS** harmless against all damages.

DC COMPONENTS disclaims any and all liability arising out of the application or use of any product, including consequential or incidental damages. Statement regarding the suitability of products for certain types of applications are based on **DC COMPONENTS**'s knowledge of typical requirements that are often placed on **DC COMPONENTS** products in generic applications. Such statements are not binding statements about the suitability of products for a particular application. It is the customer's responsibility to validate that a particular product with the properties described in the product specification is suitable for use in a particular application.

DC COMPONENTS reserve the right to make modifications, enhancements, improvements, corrections or other changes without further notice to this document and any product described herein, and disclaim any and all liability for any errors, inaccuracies or incompleteness contained in any datasheet or in any other disclosure relating to any product. Parameters provided in datasheets and specifications may vary in different applications and performance may vary over time. All operating parameters, including typical parameters, must be validated for each customer application by the customer's technical experts. Product specifications do not expand or otherwise modify **DC COMPONENTS**'s terms and conditions of purchase, including but not limited to the warranty expressed therein.

Unless otherwise in writing, **DC COMPONENTS** products are intended for use as general electronic components in standard applications (eg: Consumer electronic, Computer equipment, Office equipment, etc.), and not recommended for use in a high specific application where a failure or malfunction of the device could result in human injury or death (eg: Aerospace equipment, Submarine cables, Combustion equipment, Safety devices, Life support systems, etc.)

Customers using or selling **DC COMPONENTS** products not expressly indicated for use in such applications do so at their own risk. If customer intended to use **DC COMPONENTS** standard quality grade devices for applications not envisioned by **DC COMPONENTS**, please contact our sales representatives in advance.



DC COMPONENTS CO., LTD.