

FEATURES:

- I/O Isolation of 3000VAC or 3500VAC/6000VDC
- Maximum Capacitive load up to 1000µF
- Operating temperature: -40 to +105°C
- Efficiency up to 81%
- SIP7 Package
- Ultra-low Isolation capacitance

Models
Dual output



Model	Input Voltage (V)	Input current FL/NL (mA)	Output Voltage (V)	Output Current max (mA)	Max Capacitive Load (uF)	Efficiency (%)
AM3DG-121508DH30-NZ	11.4 – 12.6	280 40	+15 (14.1 ~ 15.6) / -8 (-6.24 ~ -9.44)	+120 / -120	1000	81
AM3DG-151508DH30-NZ	14.25 – 15.75	230 35				
AM3DG-241508DH30-NZ	22.8 – 25.2	144 30				
AM3DG-152004DH60-NZ	13.5 – 16.5	193 16	+20 / -4	+100 / -100	220	80

NOTE: All specifications in this datasheet are measured at an ambient temperature of 25°C, humidity<75%, nominal input voltage and at rated output load unless otherwise specified.

Input Specifications

Parameters	Nominal	Typical	Maximum	Units
Voltage range	See model's table			
Filter	Capacitor			
Absolute Maximum Rating	AM3DG-121508DH30-NZ		-0.7 - 14	VDC
	AM3DG-151508DH30-NZ		-0.7 - 16	VDC
	AM3DG-241508DH30-NZ		-0.7 - 26	VDC
	AM3DG-152004DH60-NZ		-0.7 - 21	VDC
Peak Input Voltage time			1000	ms

Isolation Specifications

Parameters	Conditions	Typical	Rated	Units
Tested I/O voltage	AM3DG-152004DH60-NZ, 60sec, <1mA		3500	VAC
	AM3DG-152004DH60-NZ, 60sec, <1mA		6000	VDC
	Others, 60sec, <1mA		3000	VAC
Resistance	I/O Isolation 500VDC	>1000		MOhm
Capacitance	AM3DG-152004DH60-NZ, 100KHz/0.1V	3.5		pF
	Others, 100KHz/0.1V	6		pF

Output Specifications

Parameters	Conditions	Typical	Maximum	Units
Voltage accuracy	See tolerance curve			
Short Circuit protection	AM3DG-152004DH60-NZ		Continuous, auto restart	
	Others		1	s
Line voltage regulation	AM3DG-152004DH60-NZ, HL-LL	±1.1	±1.3	%
	Others, HL-LL	±1.1	±1.2	%
Load voltage regulation	10 – 100% load: +20Vdc output	7	9	%
	10 – 100% load: -4Vdc output	10	15	%
	10 – 100% load: +15Vdc output	8	15	%
	10 – 100% load: -8Vdc output	10	15	%
Temperature coefficient	AM3DG-152004DH60-NZ, Full load	±0.03		%/°C
	Others, Full load	±0.04		%/°C
Ripple & Noise	AM3DG-152004DH60-NZ, 20MHz Bandwidth	75		mV p-p
	Others, 20MHz Bandwidth	100	200	mV p-p

General Specifications

Parameters	Conditions	Typical	Maximum	Units
Switching frequency	AM3DG-152004DH60-NZ, 100% load	95		KHz
	Others, 100% load	100		KHz
Operating temperature	Derating above 85°C	-40 to +105		°C
Storage temperature		-55 to +125		°C
Case temperature rise	AM3DG-152004DH60-NZ, Ta=25°C		30	°C
	Others, Ta=25°C		40	°C
Cooling	Free air convection			
Humidity			95	% RH
Case material	Non-conductive black plastic (UL94V-0 rated)			
Weight	AM3DG-152004DH60-NZ	4.2		g
	Others	4.3		g
Dimensions (L x W x H)	0.77 x 0.39 x 0.49 inches 19.50 x 9.80 x 12.50 mm			
MTBF	>3,500,000hrs (MIL-HDBK -217F, Ground Benign, t=+25 °C)			
Maximum soldering temperature	1.5 mm from case for 10sec		300	°C

Safety Specifications

Parameters		
Agency approvals	cULus	
Standards	UL 60950-1 (AM3DG-152004DH60-NZ only)	
	EN 55022 Class B for AM3DG-152004DH60-NZ model (see recommended circuit)	
	Electrostatic Discharge Immunity	IEC 61000-4-2, Perf. Criteria B (ESD Contact +/- 8KV), measured on the 3000VAC isolated models IEC 61000-4-2, Perf. Criteria B (ESD Contact +/- 6KV), measured on the AM3DG-152004DH60-NZ
	Electrical Fast Transient / Burst Immunity	IEC 61000-4-4, Perf. Criteria B (EFT +/- 2KV), measured on the 3000VAC isolated models
Surge Immunity	IEC 61000-4-5, Perf. Criteria B (Surge Input to Output +/- 2KV), measured on the 3000VAC isolated models	

Tolerance curve

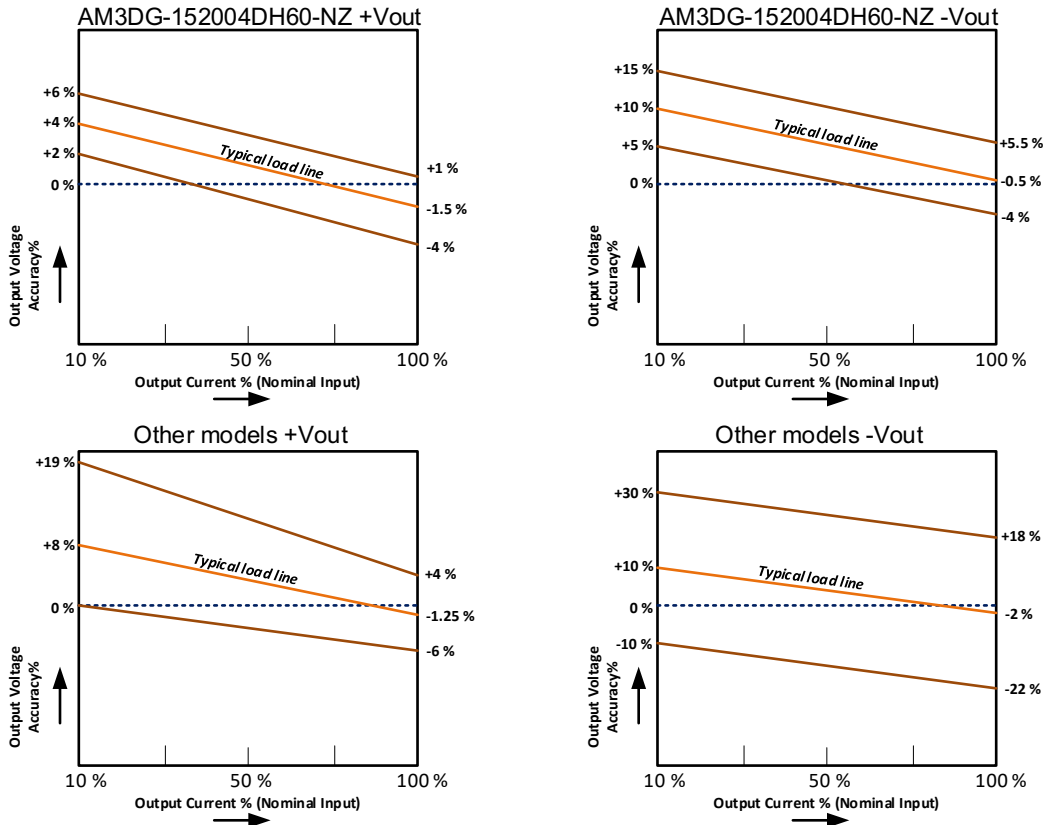

Dimensions

AM3DG-152004DH60-NZ

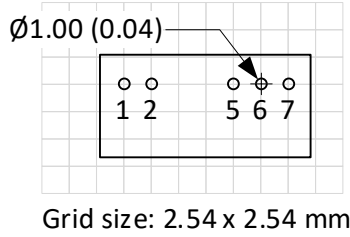
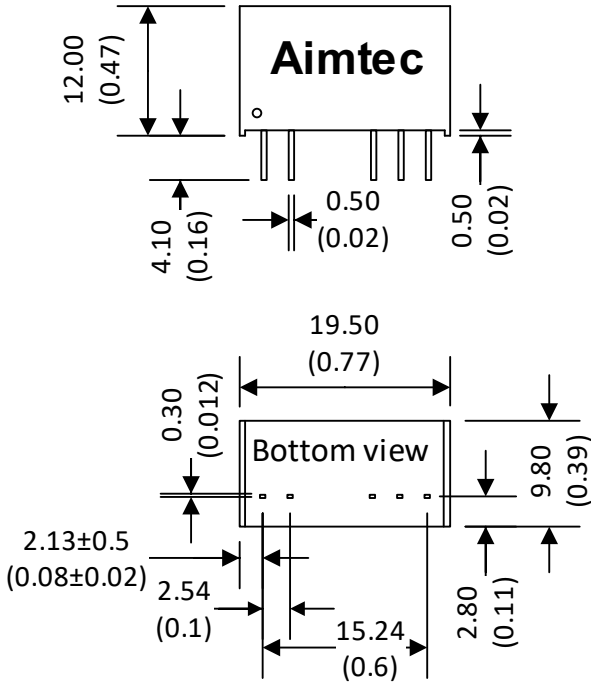

Pin Out Specifications

Pin	Dual
1	+ V Input
2	- V Input
5	- V Output
6	Common
7	+ V Output

Note:
 Unit: mm (inch)
 General tolerance: ±0.1 (0.004)
 Pin tolerance: ±0.5 (0.02)

Other models

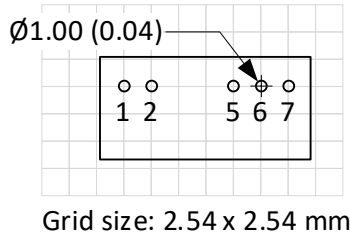
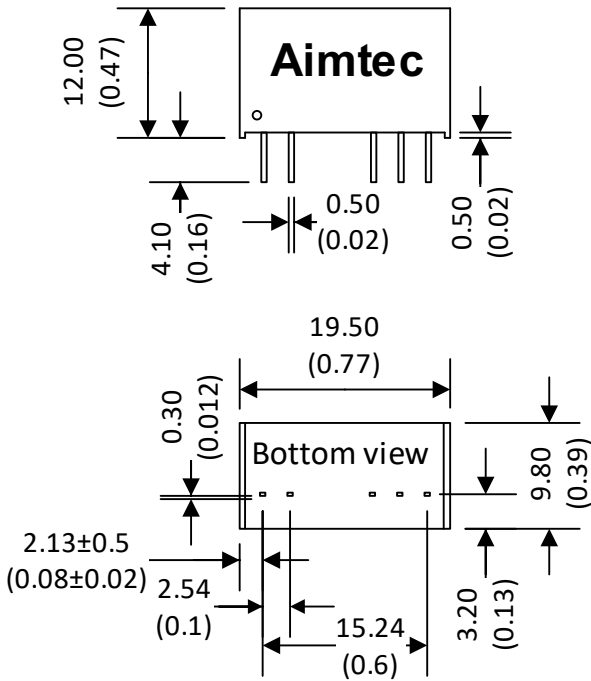

Note:
 Unit: mm (inch)
 General tolerance: ±0.1 (0.004)
 Pin tolerance: ±0.5 (0.02)

Derating

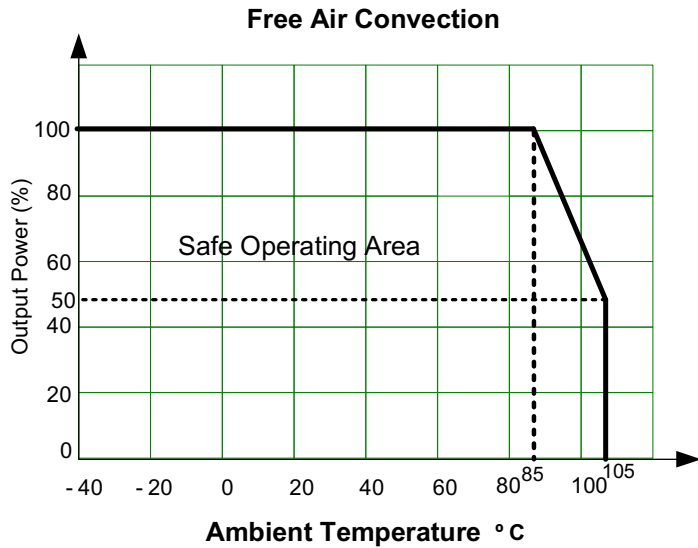

Application Circuit

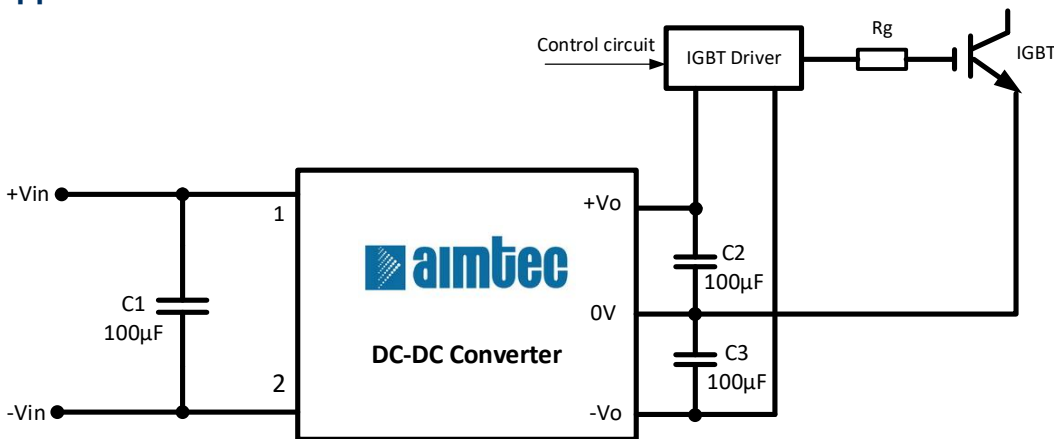

Note: Low Internal resistance capacitors suggested

EMI Recommended Circuit (Class B for AM3DG-152004DH60-NZ)



NOTE: 1. Datasheets are updated as needed and as such, specifications are subject to change without notice. Once printed or downloaded, datasheets are no longer controlled by Aimtec; refer to www.aimtec.com for the most current product specifications. 2. Product labels shown, including safety agency certifications on labels, may vary based on the date manufactured. 3. Mechanical drawings and specifications are for reference only. 4. All specifications are measured at an ambient temperature of 25°C, humidity<75%, nominal input voltage and at rated output load unless otherwise specified. 5. Aimtec may not have conducted destructive testing or chemical analysis on all internal components and chemicals at the time of publishing this document. CAS numbers and other limited information are considered proprietary and may not be available for release. 6. This product is not designed for use in critical life support systems, equipment used in hazardous environments, nuclear control systems or other such applications which necessitate specific safety and regulatory standards other the ones listed in this datasheet. 7. Warranty is in accordance with Aimtec's standard Terms of Sale available at www.aimtec.com.