



SPECIFICATION FOR APPROVAL

CUSTOMER: Chip

EVERCOOL MODEL NO: EC6025H12BP

CUSTOMER MODEL NO: EC6025H12BP

DESCRIPTION: DC12V FAN

APPROVED BY (AUTHORISED)	APPROVED
	Alex
	CHECKED
	Guoruihua
	DRAWN
	Libingbing
	SALES
	Teddy

* Please confirm your acceptance by return fax or mail.

SPEC NO	ISSUE DATE	EDITION	REVISED DATE
20151126A14	2015/11/26	A0	2015/11/26

THE PRODUCTION ACCORD WITH EUROPE UNION ROHS STANDARD

EVERCOOL THERMAL CO., LTD

NO. 123-8, HSING DE RD., SAN-CHUNG CITY,

TAIPEI HSIEN, TAIWAN, R.O.C.

TEL: 886-2-8512-2889 FAX: 886-2-8512-2890

[URL:www.evercool.com.tw](http://www.evercool.com.tw)

[EMAIL: coolest@ms14.hinet.net](mailto:coolest@ms14.hinet.net)

I. GENERAL SPECIFICATION

Item	Specification	
1.Part NO.	EC6025H12BP	
2.Outline Dimension	60*60*25	
3.Rated Voltage	12	VDC
4.Rated Current*	0.24	A(Max)
5.Rated Power Consumption*	2.88	W
6.Rated Speed*	2000RPM±25%	5000RPM±10%
7.Airflow**	9.92CFM(ft3/min)	26.63CFM(ft3/min)
8.Static Pressure**	0.049In-H2O	0.28In-H2O
9.Noise Level***	<11.9dB(A)	<36dB(A)
10.Life Expectancy	50000 hrs at 25°C	
11.No of Polarity	4 Poles	
12.Direction of Rotation	Counter-Clockwise	

Noted:

***Input Current Speed Power Consumption**

Measured after continuous 30 minutes

operation at rated voltage in free air

at ambient temperature of 25 °C, 65% relative humidity

****Performance**

Measured with use of double chamber. The value

are recorded when the fan speed is stabilized

at rated voltage.

*****Noise Level**

Measured at rated voltage in a semi-anechoic chamber

with background noise below than 17 dB(A).

The measuring distance is in one meter from microphone

to inlet of the fan.

II. ELECTRICAL SPECIFICATION

Item		Specification
1.Polarity Protection	✓ YES	Be capable of endurance when Vcc & GRD are exchanged
	NO	
2.Auto restart	✓ YES	Locked motor protection
	NO	
3.Insulation Resistance		10MΩ/b/w unshielded wire and frame at 500 VDC/min
4.Dielectric Strength		5Ma Max./Measured b/w lead wire and frame at 500VAC/min

III. MAIN MATERIALS / PARTS SPECIFICATION

Item		Specification				
1.Materials of Frame		Thermoplastic PBT of UL 94V-0(BK)				
2.Materials of Fan Blade						
3.Bobbin						
	✓	Dual ball bearing				
		1 ball & 1 sleeve bearing				
		Sleeve bearing				
		EL bearing				
5.Lead wire	✓	Red (+)	UL#	1007	28	AWG
	✓	Black (-)	UL#	1007	28	AWG
	✓	Yellow(FG)	UL#	1007	28	AWG
	✓	Blue(PWM)	UL#	1007	28	AWG
6.Connector		2510 4P				

IV. ENVIRONMENT SPECIFICATION

Item	Specification
1.Operation Temperature	-10℃~+70℃/66%(RH), high / low temperature test for 24 hours, temperature change: 30℃/hours.
2.Storage Temperature	-40℃~+70℃/66%(RH), high / low temperature test for 24 hours, temperature change: 30℃/hours.

V. DROPPING TEST

Prepared in minimum packing condition, fan will withstand one drop each on three surfaces from 30 cm height onto a 10mm thick hard wooden board.

VI. LABEL MARKING

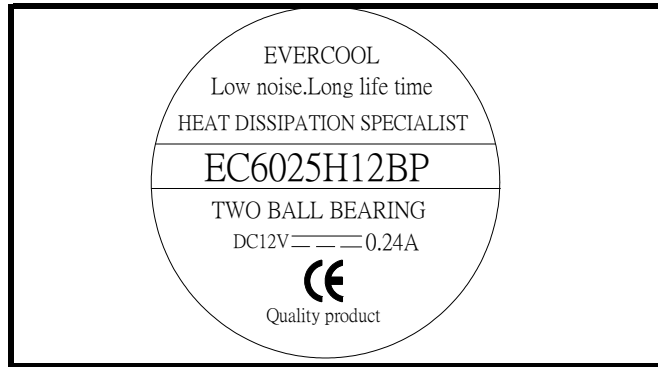

VII. OUTLINE DIMENSION

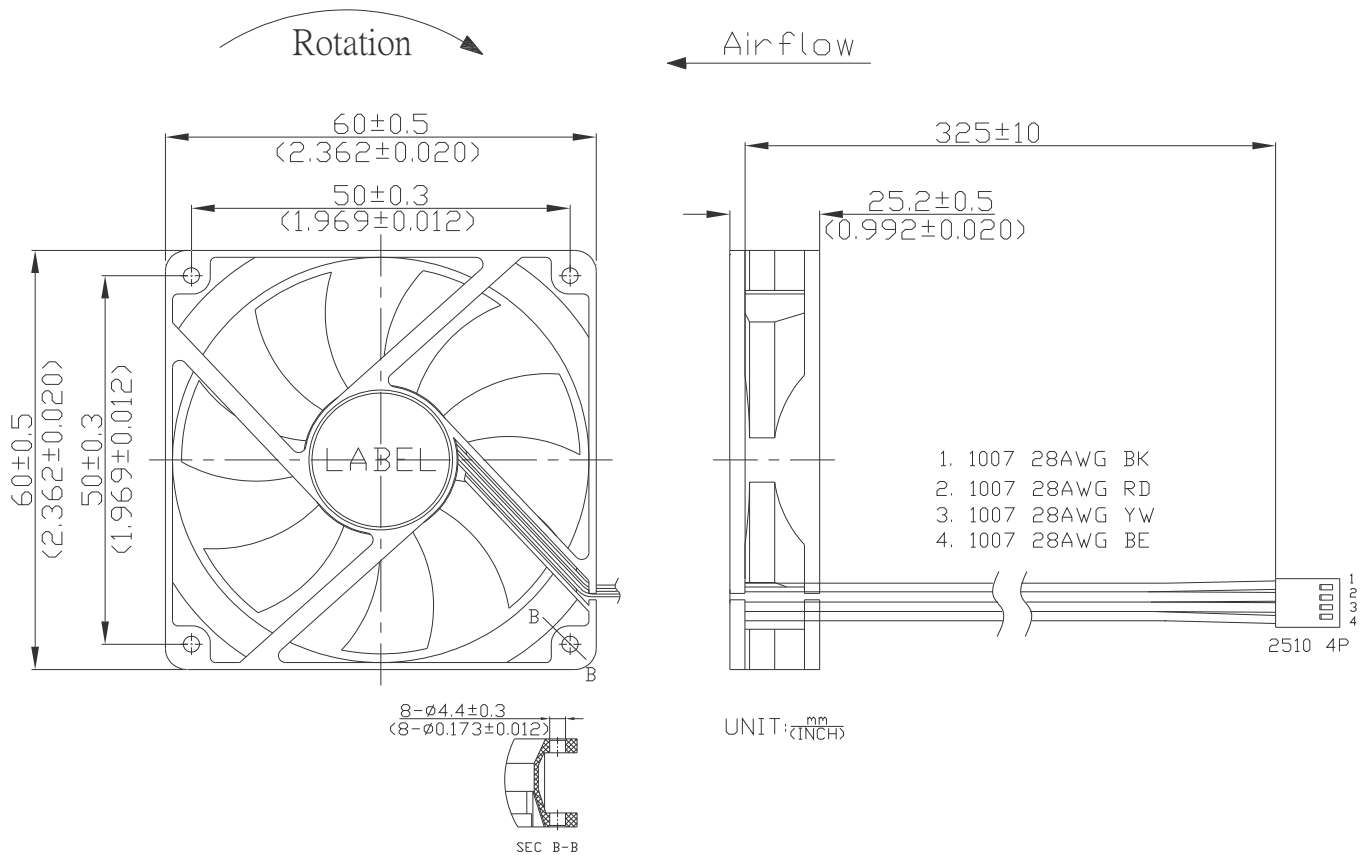

VIII.PWM CONTROL SIGNAL:

Signal Voltage Range:-0.8-20VDC.

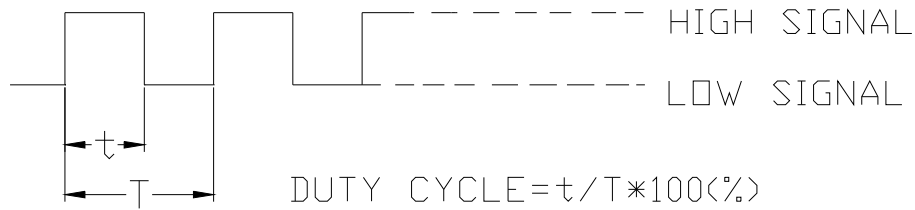

.The frequency for control signal of the fan shall be able to accept a 18KHZ-32KHZ.

The preferred operating point for the fan is 25k HZ.

.At 100% duty cycle ,The rotor will spin at maximum speed.

At 0% duty cycle, The rotor will stop spin.

At 25KHZ 20% duty cycle ,The fan will be able to star from a dead stop.

SPEED VS PWM CONTROL SIGNAL:

(AT RATED VOLTAGE & PWM FREQUENCY=25KHZ)

DUTY CYCLE(%)	SPEED.PWM(REF)	CURRENT(A)TYP
100	5000±10%	0.24
75	4500±10%	0.15
50	3800±15%	0.12
25	3100±20%	0.08
0	2000±25%	0.06

IX. Sensor Curcuit System

PWM CONTROL

In PWM speed control, a fixed frequency square wave is applied to the speed control lead wire of the fan. The ratio of the on time vs. the PWM period is proportional to the RPM.

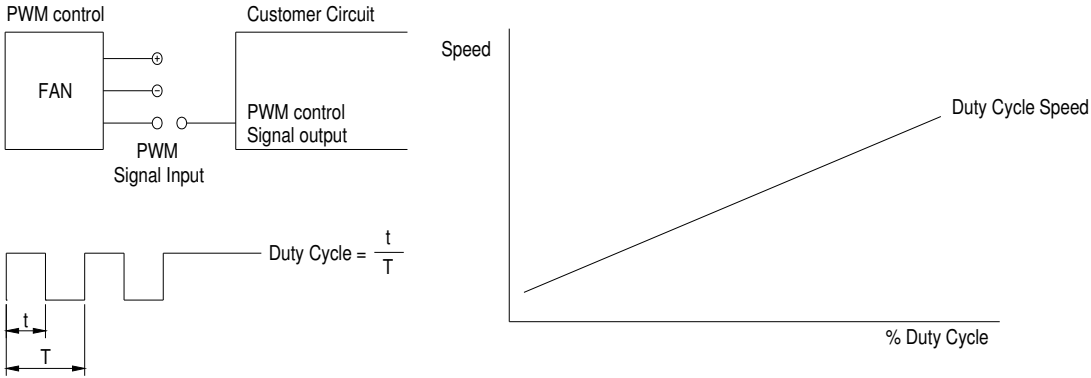

PWM INPUT VOLTAGE RANGE:

High level= 2.8 to 20 VDC
 Low level= 0 to 0.4 VDC

PWM INPUT CURRENT (IPWM) RANGE:

40uA to 20mA

To control signal line of the fan shall be able to accept a 30Hz to 30kHz.
 The preferred operating point for the fan is 0%~100% of duty cycle.

X.Fan Duty Cycle Vs RPM Curve

6025duty cycle vs rpm curve

RPM

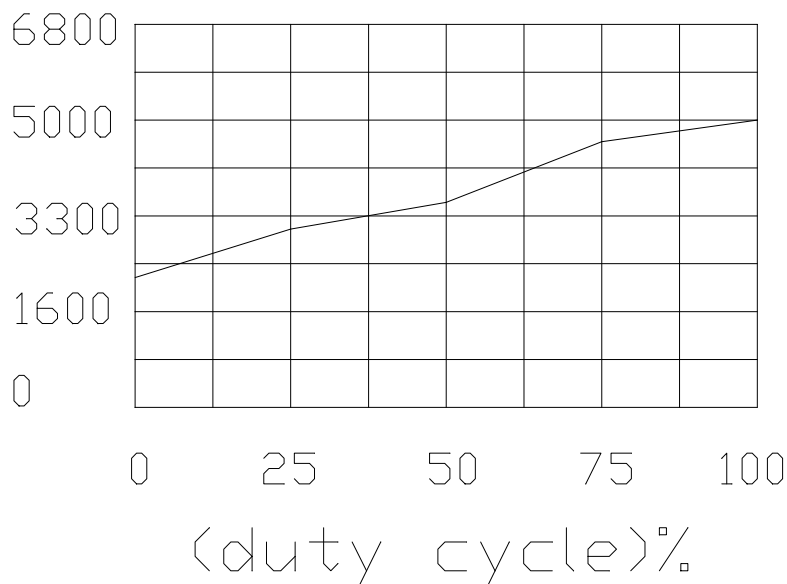

VIII. Sensor Curcuit System

Speed Sensor / Tachometer (FG/F)

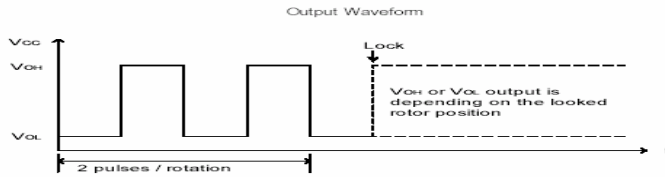
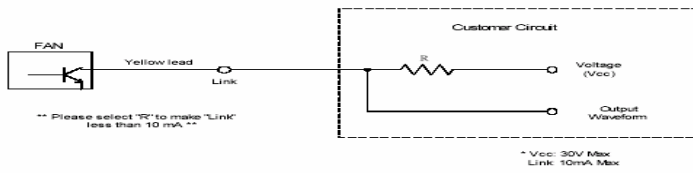

XI. P/Q Performance

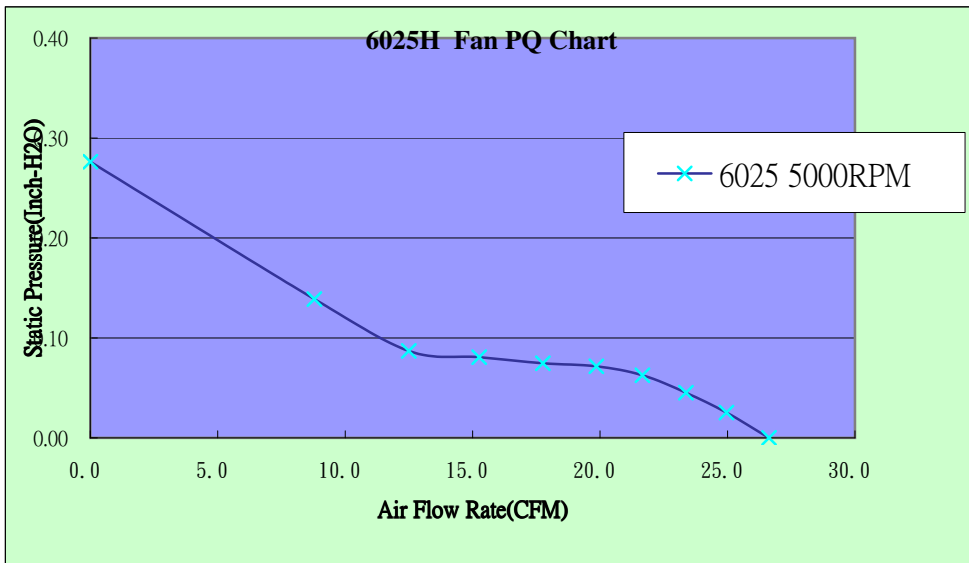

	Q(cfm)	Ps(InchH2o)
1	0.000	0.276
2	8.789	0.139
3	12.498	0.087
4	15.255	0.081
5	17.758	0.075
6	19.854	0.072
7	21.663	0.063
8	23.371	0.045
9	24.961	0.025
10	26.627	0.000