

AMASS 规格书

版本号:V1.2

■产品型号 (Item No): XT30PW-M

■专利号 (Patent): 201530416577.6

■客户图纸 (Drawing)

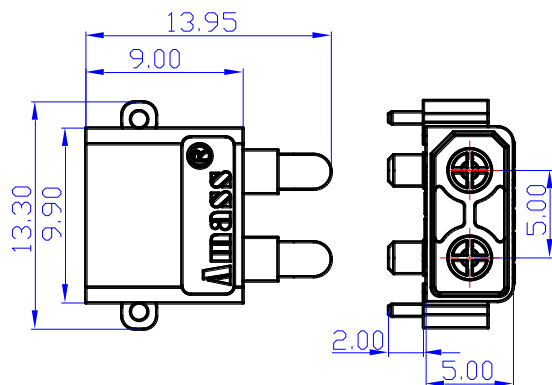

安装孔示意图

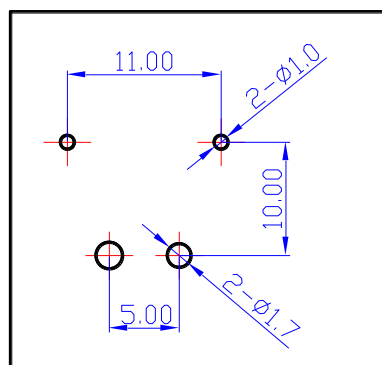

■产品材质及基本参数 (Material & Parameter)

产品型号 Item No.	XT30PW-M	接触电阻 CR	0.80mΩ
颜色 COLOR	3	额定电压	DC 500V
金属材质 Metal Material	铜镀金 Brass Gold Plated	额定电流 RC	15A
绝缘材质 Plastic Material	PA	瞬时电流 MC	30A
阻燃等级 FR LEVEL	UL94 V0	推荐使用次数 USE TIMES	1000 TIMES
推荐应用 Recommend USE	控制器/充电器 CONTROLLER/ CHARGER	推荐线规 Cable SPEC.	PCB
安规认证 CERTIFICATION	CE/UL	工作温度 TEMPERATURE	-20°C to 120°C

★注意: 用户的使用及环境有可能与我司测试方法有出入

(Data sheet will change according with the test background)

常州市艾迈斯电子有限公司 (Changzhou AMASS Electronics Co., Ltd)

地址(Add): 江苏省常州市武进区礼嘉镇青洋南路6公里处

(QingYang Road, Lijia Town, Wujin Dis. Changzhou City, Jiangsu Pro.)

电话(Tel): 86-519-86731695 传真(Fax): 86-519-86735861

邮编(Zip): 213176

E-mail: hzy@china-amass.com

网址(Web): www.china-amass.com

AMASS 规格书

版本号:V1.2

■产品型号 (Item No): XT30PW-F

■专利号 (Patent): 201530416577.6

■客户图纸 (Drawing)

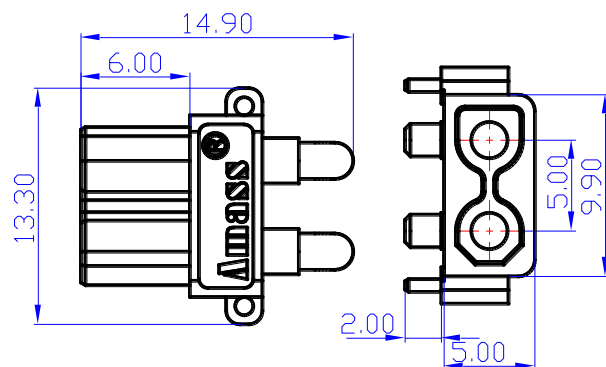

安装孔示意图

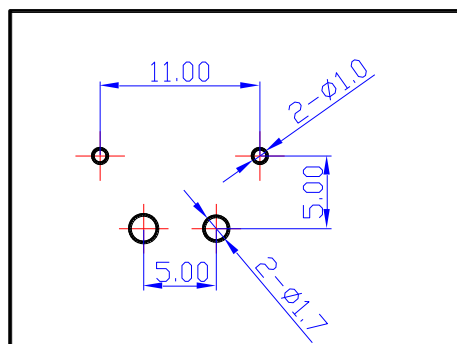

■产品材质及基本参数 (Material & Parameter)

产品型号 Item No.	XT30PW-F	接触电阻 CR	0.80mΩ
颜色 COLOR	3	额定电压	DC 500V
金属材质 Metal Material	铜镀金 Brass Gold Plated	额定电流 RC	15A
绝缘材质 Plastic Material	PA	瞬时电流 MC	30A
阻燃等级 FR LEVEL	UL94 V0	推荐使用次数 USE TIMES	1000 TIMES
推荐应用 Recommend USE	电池 BATTERY	推荐线规 Cable SPEC.	PCB
安规认证 CERTIFICATION	CE/UL	工作温度 TEMPERATURE	-20℃ to 120℃

★注意: 用户的使用及环境有可能与我司测试方法有出入
(Data sheet will change according with the test background)

常州市艾迈斯电子有限公司 (Changzhou AMASS Electronics Co., Ltd)

地址(Add): 江苏省常州市武进区礼嘉镇青洋南路6公里处

(QingYang Road, Lijia Town, Wujin Dis. Changzhou City, Jiangsu Pro.)

电话(Tel): 86-519-86731695 传真(Fax): 86-519-86735861

邮编(Zip): 213176

E-mail: hzy@china-amass.com

网址(Web): www.china-amass.com