

**NPN Silicon Darlington Transistors**

- For general AF applications
- High collector current
- High current gain
- Complementary types: BCV28, BCV48 (PNP)
- Pb-free (RoHS compliant) package
- Qualified according AEC Q101

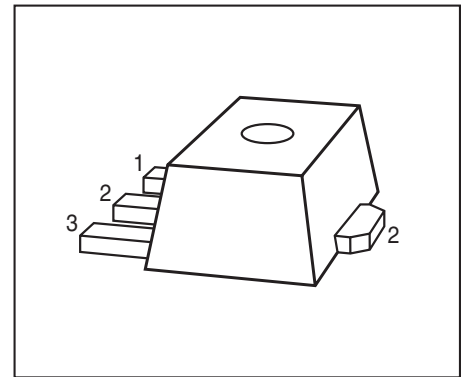

Type	Marking	Pin Configuration			Package
		1=B	2=C	3=E	
BCV29	EF	1=B	2=C	3=E	SOT89
BCV49	EG	1=B	2=C	3=E	SOT89

**Maximum Ratings**

Parameter	Symbol	Value	Unit
Collector-emitter voltage	$V_{CEO}$		V
BCV29		30	
BCV49		60	
Collector-base voltage	$V_{CBO}$		
BCV29		40	
BCV49		80	
Emitter-base voltage	$V_{EBO}$	10	
Collector current	$I_C$	500	mA
Peak collector current, $t_p \leq 10$ ms	$I_{CM}$	800	
Base current	$I_B$	100	
Peak base current	$I_{BM}$	200	
Total power dissipation- $T_S \leq 130$ °C	$P_{tot}$	1	W
Junction temperature	$T_j$	150	°C
Storage temperature	$T_{stg}$	-65 ... 150	

**Thermal Resistance**

Parameter	Symbol	Value	Unit
Junction - soldering point <sup>1)</sup>	$R_{thJS}$	$\leq 20$	K/W

<sup>1)</sup>For calculation of  $R_{thJA}$  please refer to Application Note AN077 (Thermal Resistance Calculation)

**Electrical Characteristics at  $T_A = 25^\circ\text{C}$ , unless otherwise specified**

Parameter	Symbol	Values			Unit
		min.	typ.	max.	

**DC Characteristics**

Collector-emitter breakdown voltage $I_C = 10\text{ mA}$ , $I_B = 0$ , BCV29 $I_C = 10\text{ mA}$ , $I_B = 0$ , BCV49	$V_{(BR)CEO}$	30 60	- -	- -	V
Collector-base breakdown voltage $I_C = 100\text{ }\mu\text{A}$ , $I_E = 0$ , BCV29 $I_C = 100\text{ }\mu\text{A}$ , $I_E = 0$ , BCV49	$V_{(BR)CBO}$	40 80	- -	- -	
Emitter-base breakdown voltage $I_E = 10\text{ }\mu\text{A}$ , $I_C = 0$	$V_{(BR)EBO}$	10	-	-	
Collector-base cutoff current $V_{CB} = 30\text{ V}$ , $I_E = 0$ , BCV29 $V_{CB} = 60\text{ V}$ , $I_E = 0$ , BCV49 $V_{CB} = 30\text{ V}$ , $I_E = 0$ , $T_A = 150^\circ\text{C}$ , BCV29 $V_{CB} = 60\text{ V}$ , $I_E = 0$ , $T_A = 150^\circ\text{C}$ , BCV49	$I_{CBO}$	- - - -	- - - -	0.1 0.1 10 10	$\mu\text{A}$
Emitter-base cutoff current $V_{EB} = 4\text{ V}$ , $I_C = 0$	$I_{EBO}$	-	-	100	nA
DC current gain <sup>1)</sup> $I_C = 100\text{ }\mu\text{A}$ , $V_{CE} = 1\text{ V}$ , BCV29 $I_C = 100\text{ }\mu\text{A}$ , $V_{CE} = 1\text{ V}$ , BCV49 $I_C = 10\text{ mA}$ , $V_{CE} = 5\text{ V}$ , BCV29 $I_C = 10\text{ mA}$ , $V_{CE} = 5\text{ V}$ , BCV49 $I_C = 100\text{ mA}$ , $V_{CE} = 5\text{ V}$ , BCV29 $I_C = 100\text{ mA}$ , $V_{CE} = 5\text{ V}$ , BCV49 $I_C = 0.5\text{ A}$ , $V_{CE} = 5\text{ V}$ , BCV29 $I_C = 0.5\text{ A}$ , $V_{CE} = 5\text{ V}$ , BCV49	$h_{FE}$	4000 2000 10000 4000 20000 10000 4000 2000	- - - - - - - -	- - - - - - - -	-
Collector-emitter saturation voltage <sup>1)</sup> $I_C = 100\text{ mA}$ , $I_B = 0.1\text{ mA}$	$V_{CEsat}$	-	-	1	V
Base emitter saturation voltage <sup>1)</sup> $I_C = 100\text{ mA}$ , $I_B = 0.1\text{ mA}$	$V_{BEsat}$	-	-	1.5	

<sup>1</sup>Pulse test:  $t < 300\mu\text{s}$ ;  $D < 2\%$ 
**Electrical Characteristics** at  $T_A = 25^\circ\text{C}$ , unless otherwise specified

Parameter	Symbol	Values			Unit
		min.	typ.	max.	
<b>AC Characteristics</b>					
Transition frequency $I_C = 50\text{ mA}$ , $V_{CE} = 5\text{ V}$ , $f = 100\text{ MHz}$	$f_T$	-	150	-	MHz
Collector-base capacitance $V_{CB} = 10\text{ V}$ , $f = 1\text{ MHz}$	$C_{cb}$	-	3	-	pF

**DC current gain  $h_{FE} = f(I_C)$**

$V_{CE} = 5\text{ V}$

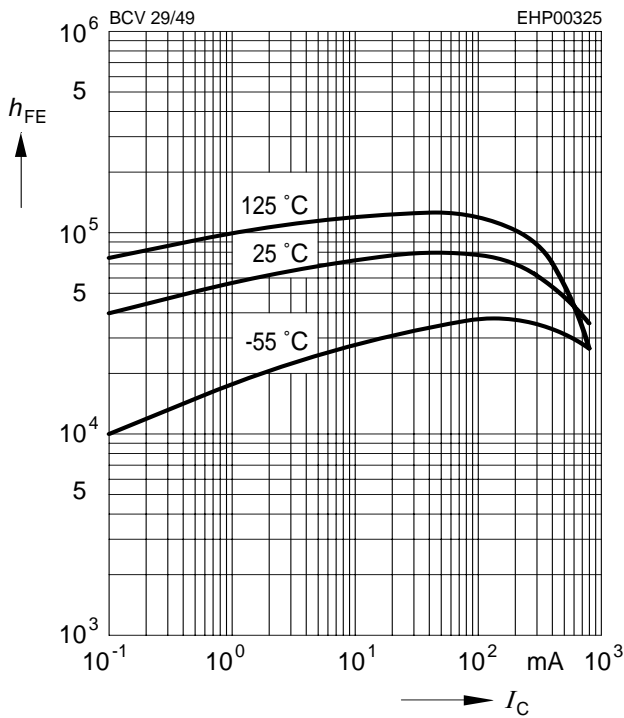

**Collector-emitter saturation voltage**

$I_C = f(V_{CEsat}), h_{FE} = 1000$

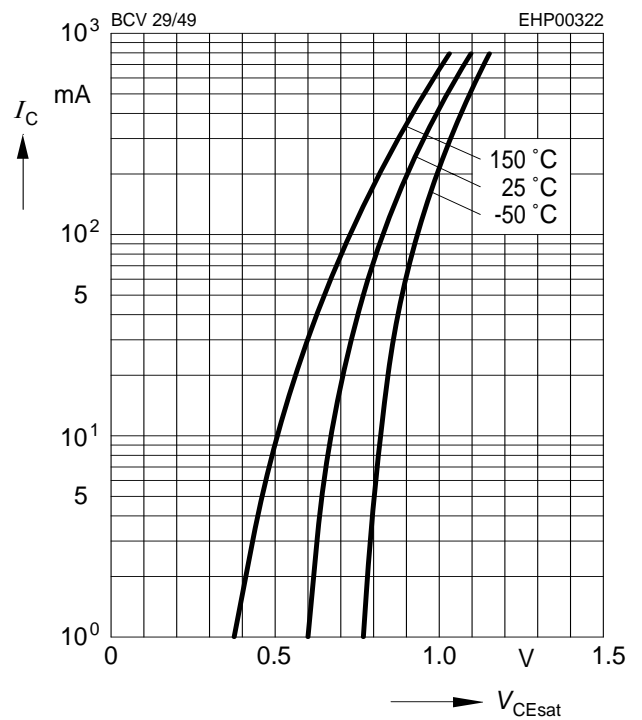

**Base-emitter saturation voltage**

$I_C = f(V_{BEsat}), h_{FE} = 1000$

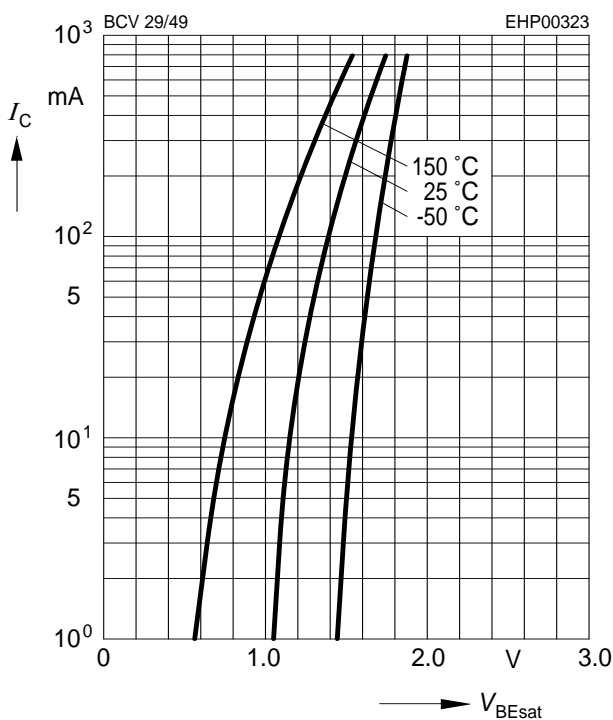

**Collector cutoff current  $I_{CBO} = f(T_A)$**

$V_{CB} = V_{CEmax}$

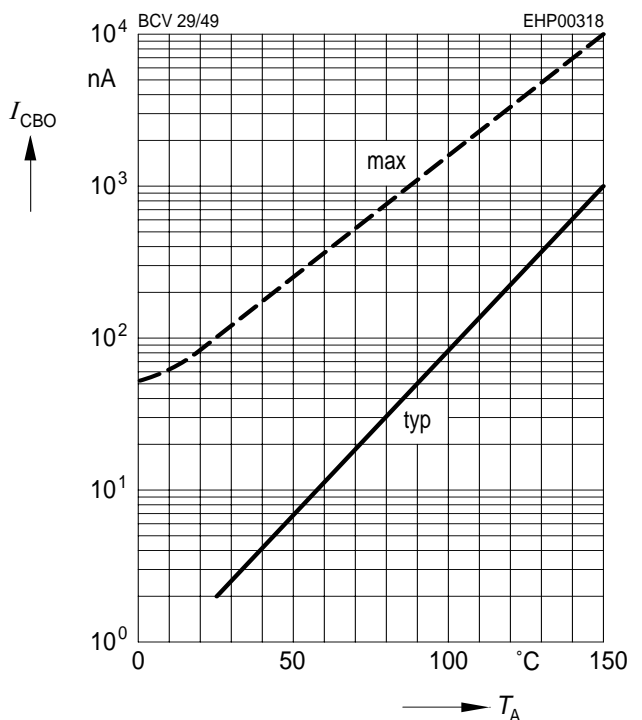

Transition frequency  $f_T = f(I_C)$

$V_{CE} = 5\text{ V}$

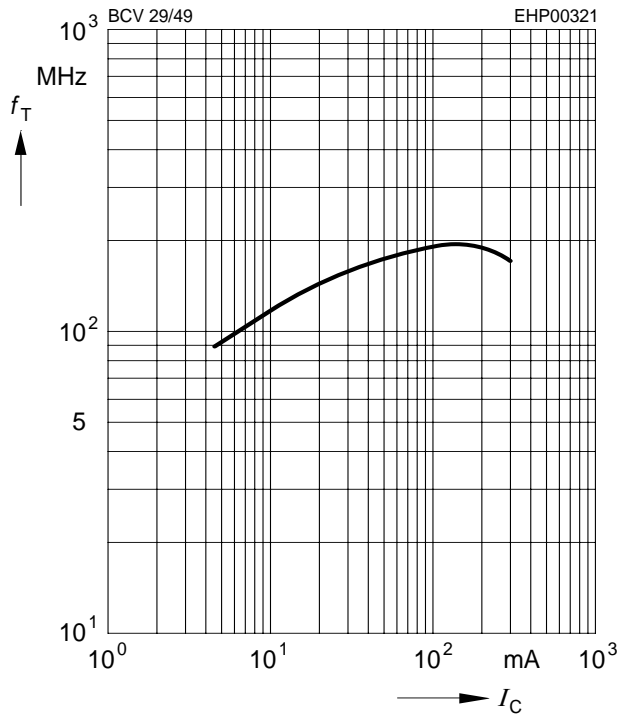

Collector-base capacitance  $C_{cb} = f(V_{CB})$

Emitter-base capacitance  $C_{eb} = f(V_{EB})$

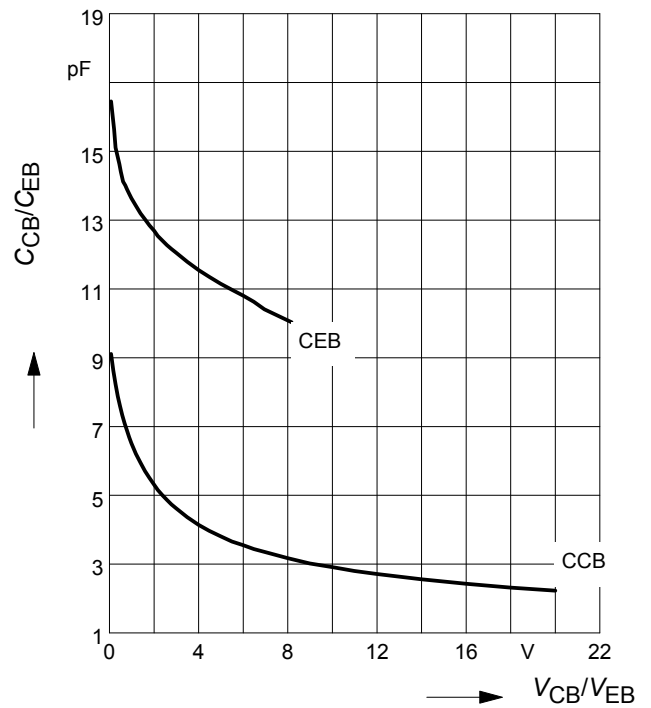

Total power dissipation  $P_{tot} = f(T_S)$

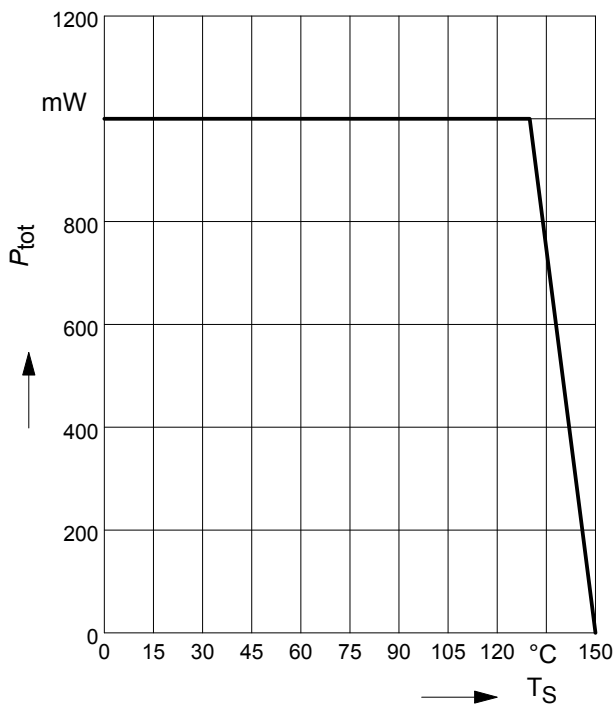

Permissible Pulse Load

$P_{totmax}/P_{totDC} = f(t_p)$

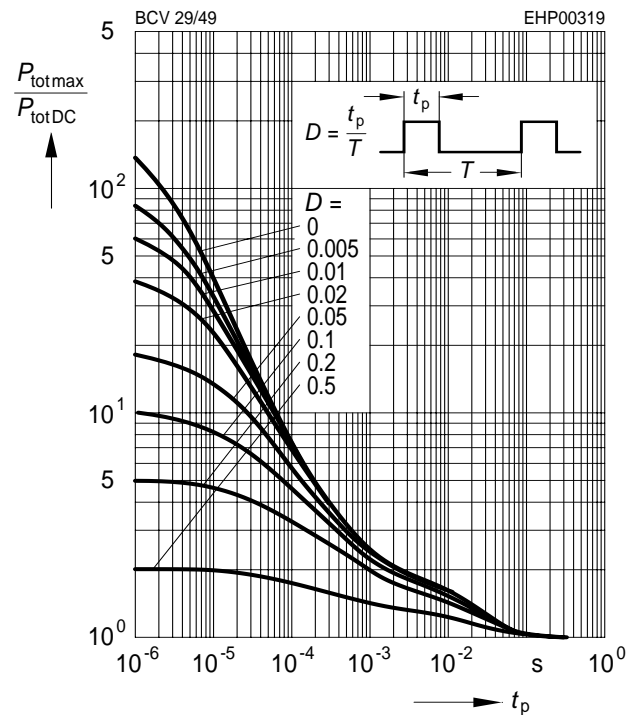



**Edition 2009-11-16**

**Published by  
Infineon Technologies AG  
81726 Munich, Germany**

**© 2009 Infineon Technologies AG  
All Rights Reserved.**

### **Legal Disclaimer**

The information given in this document shall in no event be regarded as a guarantee of conditions or characteristics. With respect to any examples or hints given herein, any typical values stated herein and/or any information regarding the application of the device, Infineon Technologies hereby disclaims any and all warranties and liabilities of any kind, including without limitation, warranties of non-infringement of intellectual property rights of any third party.

### **Information**

For further information on technology, delivery terms and conditions and prices, please contact the nearest Infineon Technologies Office ([www.infineon.com](http://www.infineon.com)).

### **Warnings**

Due to technical requirements, components may contain dangerous substances. For information on the types in question, please contact the nearest Infineon Technologies Office.

Infineon Technologies components may be used in life-support devices or systems only with the express written approval of Infineon Technologies, if a failure of such components can reasonably be expected to cause the failure of that life-support device or system or to affect the safety or effectiveness of that device or system. Life support devices or systems are intended to be implanted in the human body or to support and/or maintain and sustain and/or protect human life. If they fail, it is reasonable to assume that the health of the user or other persons may be endangered.