

### Features :

- Isolated mounting base 2500V~
- Pressure contact technology with Increased power cycling capability
- Space and weight saving

### Typical Applications

- AC/DC Motor drives
- Various rectifiers
- DC supply for PWM inverter

$V_{DSM}, V_{RSM}$	$V_{DRM}, V_{RRM}$	Type & Outline
900V	800V	MTx350-08-415F3
1100V	1000V	MTx350-10-415F3
1300V	1200V	MTx350-12-415F3
1500V	1400V	MTx350-14-415F3
1700V	1600V	MTx350-16-415F3
1900V	1800V	MTx350-18-415F3

SYMBOL	CHARACTERISTIC	TEST CONDITIONS	$T_j(^{\circ}C)$	VALUE			UNIT
				Min	Type	Max	
$I_{T(AV)}$	Mean on-state current	180° half sine wave 50Hz Single side cooled, $T_c=85^{\circ}C$	125			350	A
$I_{T(RMS)}$	RMS on-state current		125			549	A
$I_{DRM}$ $I_{RRM}$	Repetitive peak current	at $V_{DRM}$ at $V_{RRM}$	125			35	mA
$I_{TSM}$	Surge on-state current	10ms half sine wave	125			11	KA
$I^2t$	$I^2t$ for fusing coordination	$V_R=60\%V_{RRM}$				605	$A^2s \cdot 10^3$
$V_{TO}$	Threshold voltage		125			0.95	V
$r_T$	On-state slop resistance					0.36	mΩ
$V_{TM}$	Peak on-state voltage	$I_{TM}=1050A$	25			1.45	V
$dv/dt$	Critical rate of rise of off-state voltage	$V_{DM}=67\%V_{DRM}$	125			800	V/μs
$di/dt$	Critical rate of rise of on-state current	Gate source 1.5A $t_r \leq 0.5\mu s$ Repetitive	125			100	A/μs
$I_{GT}$	Gate trigger current	$V_A=12V, I_A=1A$	25	30		180	mA
$V_{GT}$	Gate trigger voltage			1.0		2.5	V
$I_H$	Holding current			20		150	mA
$V_{GD}$	Non-trigger gate voltage	$V_{DM}=67\%V_{DRM}$	125	0.2			V
$R_{th(j-c)}$	Thermal resistance Junction to case	Single side cooled per chip				0.090	$^{\circ}C/W$
$R_{th(c-h)}$	Thermal resistance case to heatsink	Single side cooled per chip				0.04	$^{\circ}C/W$
$V_{iso}$	Isolation voltage	50Hz, R.M.S, $t=1min, I_{iso}:1mA(MAX)$		2500			V
$F_m$	Thermal connection torque(M10)				12.0		N·m
	Mounting torque(M6)				6.0		N·m
$T_{stg}$	Stored temperature			-40		125	$^{\circ}C$
$W_t$	Weight				1280		g
Outline	415F3						

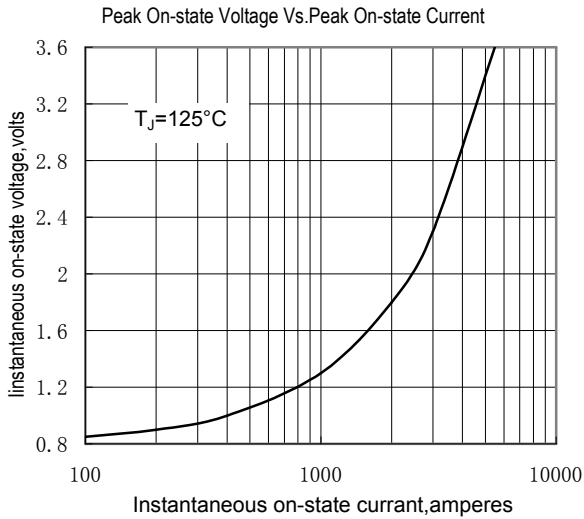


Fig.1

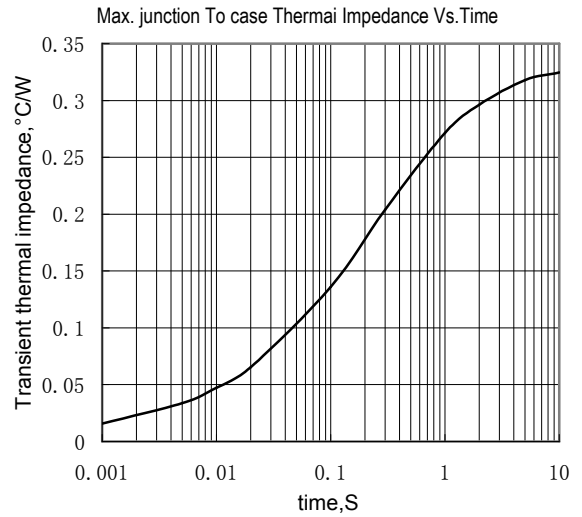


Fig.2

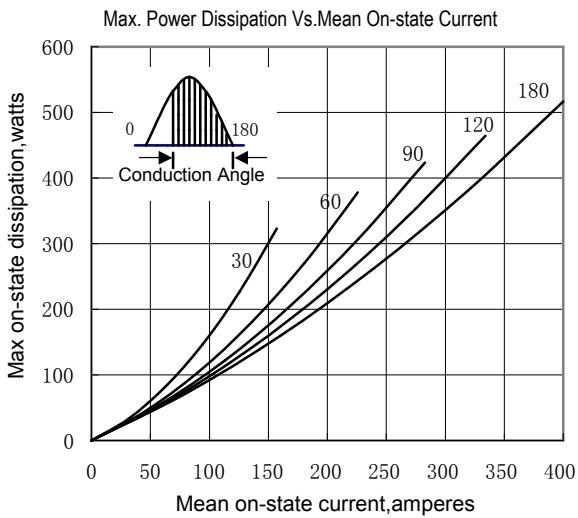


Fig.3

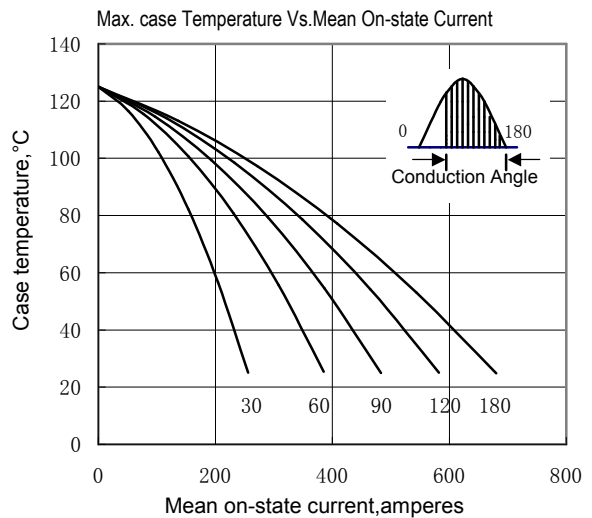


Fig.4

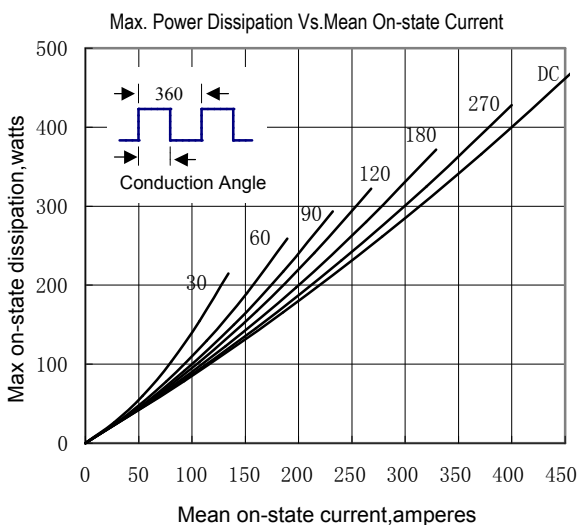


Fig.5

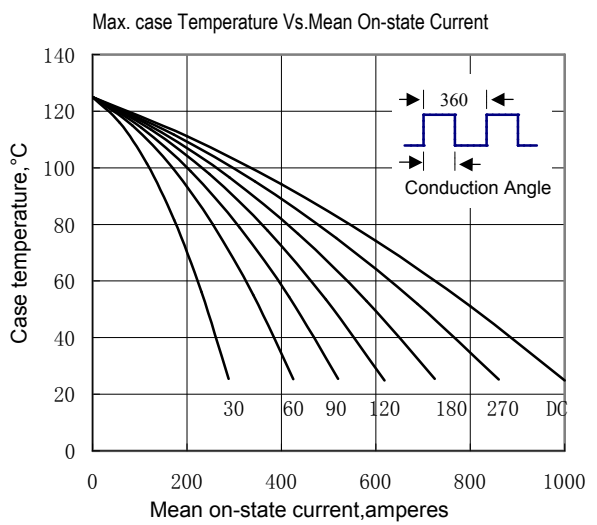
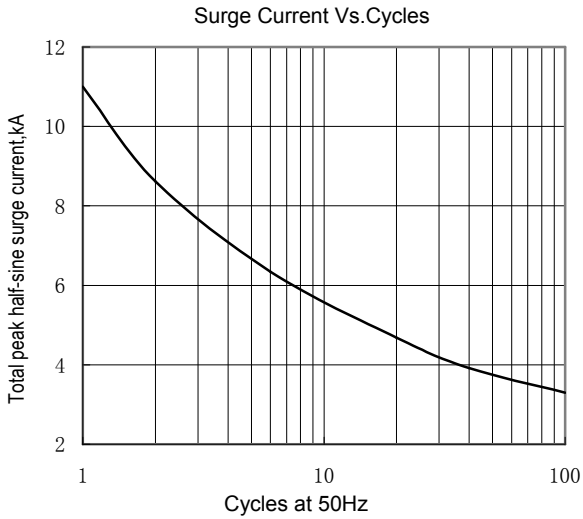
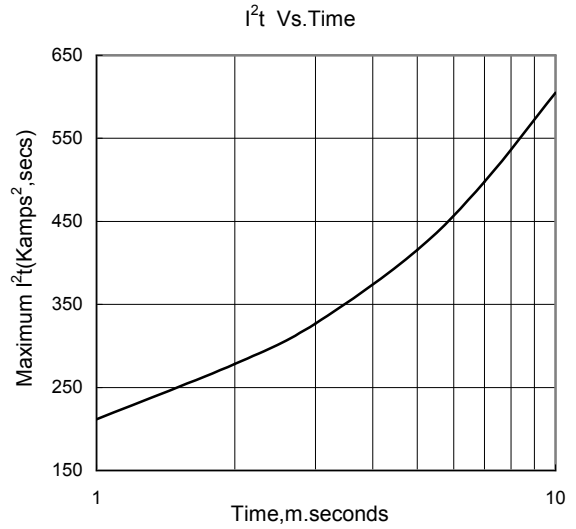


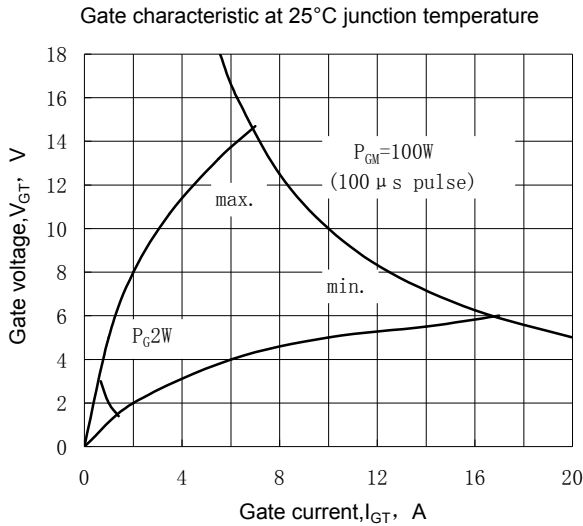
Fig.6



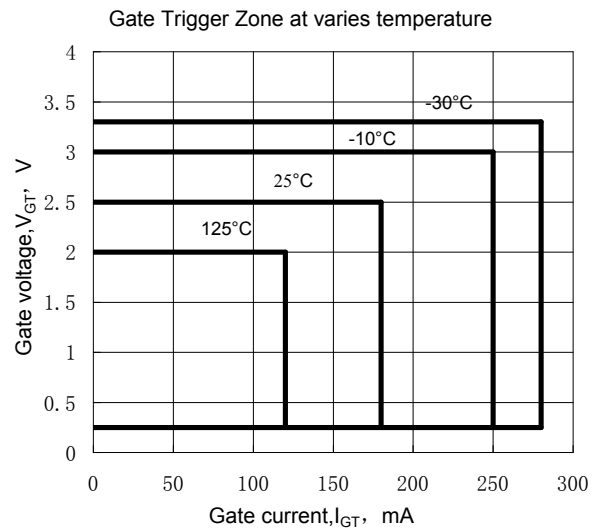
**Fig.7**



**Fig.8**

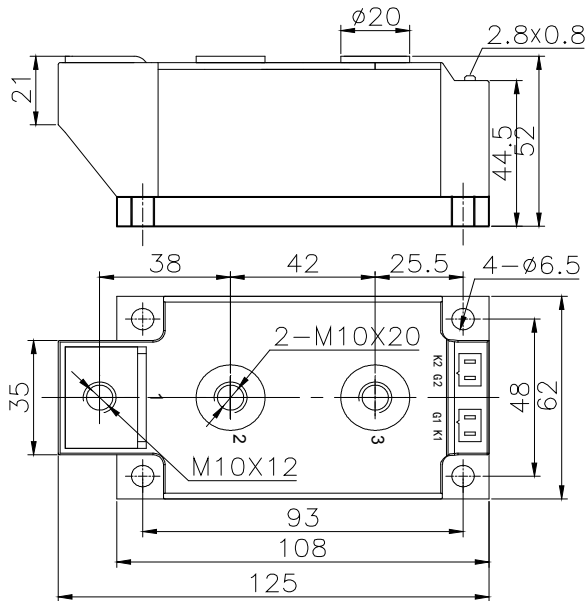


**Fig.9**



**Fig.10**

**Outline:**



**415F3**

