

Box Header Series

KLS1-201B Ejector Header 2.00mm Straight Pin Type

Electrical Characteristics:

Current Rating: 1 AMP
 Insulator Resistance: 1000MΩmin. at DC 500V
 Contact Resistance: 20mΩmax. at DC 100mA
 Operating Temperature: -45°C~+105°C

Material:

Housing: 30% Glass filled PBT UL94V-0
 Contacts: Bronze
 Plating: Gold plated: 1u". over 50u" nickel
 Selective gold plated: Standard gold on mating area and tin plated on solder tail.

Features:

- * Fully shrouded provides ultimate reliability,
- * Black or gray insulator available.
- * Choices of Eject lever.

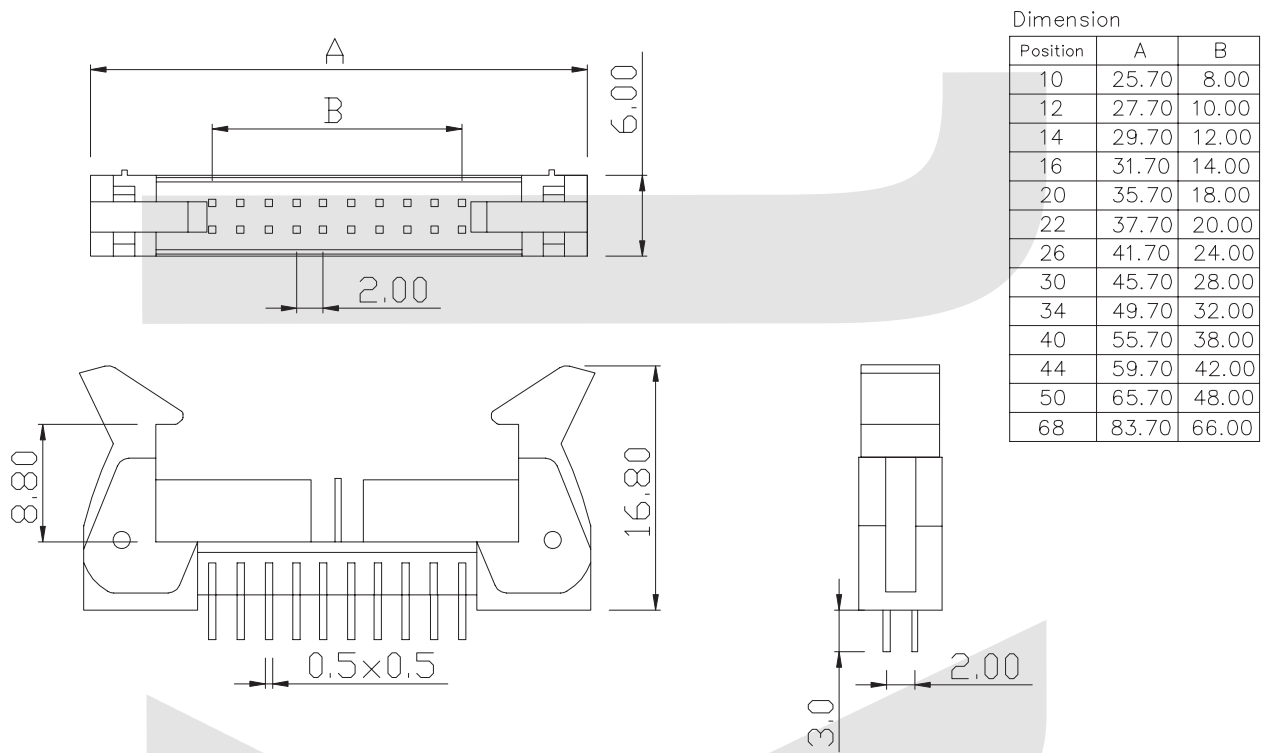
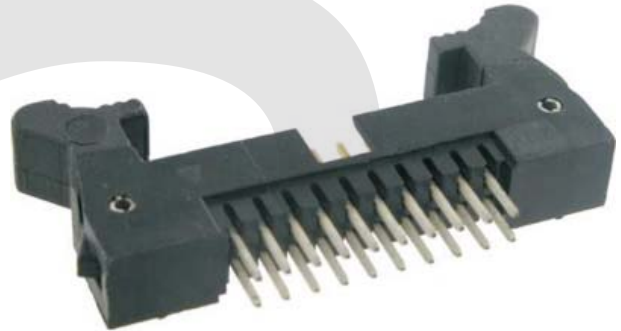

ORDER INFORMATION

Product No.: KLS1-201B-XX-S-B

Pos. No. _____ B=Black G=Gray
 Ejector Header 2.00mm _____ S=Straight Pin R=Right Pin T=SMT Pin
 Number of Contacts: XX=10-68Pin _____

Box Header Series

KLS1-201B Ejector Header 2.00mm Right Pin Type

Electrical Characteristics:

Current Rating: 1 AMP
 Insulator Resistance: 1000MΩmin. at DC 500V
 Contact Resistance: 20mΩmax. at DC 100mA
 Operating Temperature: -45°C~+105°C

Material:

Housing: 30% Glass filled PBT UL94V-0
 Contacts: Bronze
 Plating: Gold plated: 1u". over 50u" nickel
 Selective gold plated: Standard gold on mating area and tin plated on solder tail.

Features:

- * Fully shrouded provides ultimate reliability,
- * Black or gray insulator available.
- * Choices of Eject lever.

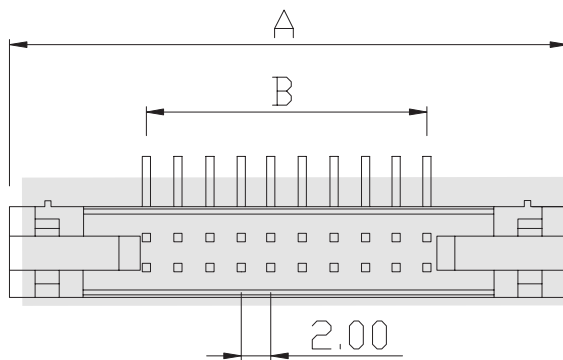
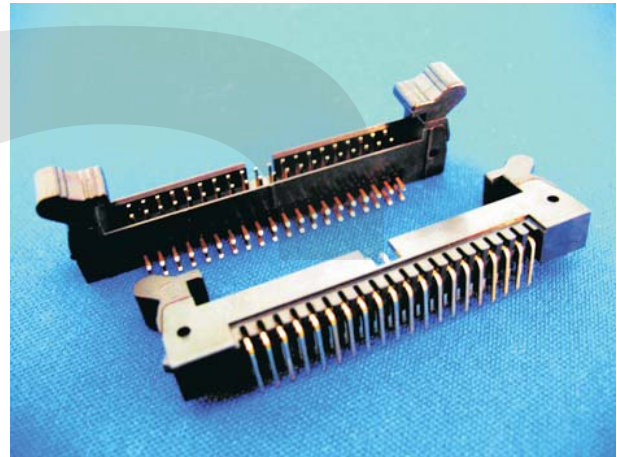

Dimension

Position	A	B
10	25.70	8.00
12	27.70	10.00
14	29.70	12.00
16	31.70	14.00
20	35.70	18.00
22	37.70	20.00
26	41.70	24.00
30	45.70	28.00
34	49.70	32.00
40	55.70	38.00
44	59.70	42.00
50	65.70	48.00
68	83.70	66.00

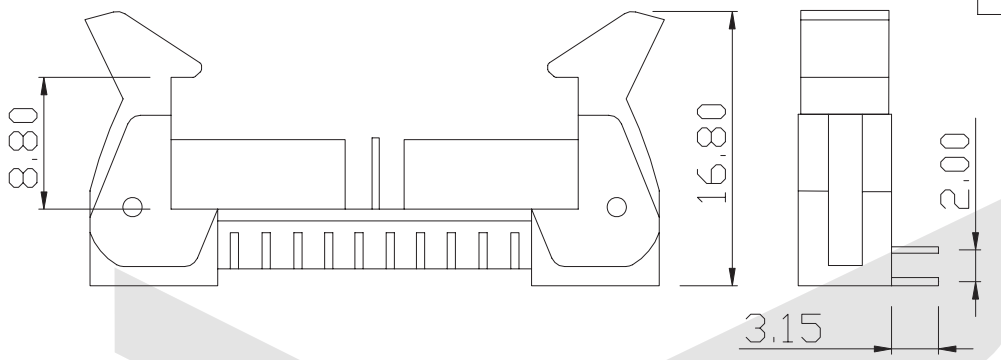

ORDER INFORMATION

Product No.: KLS1-201B-XX-R-B

Pos. No. _____ B=Black G=Gray
 Ejector Header 2.00mm _____ S=Straight Pin R=Right Pin T=SMT Pin
 Number of Contacts: XX=10-68Pin _____

Box Header Series

KLS1-201B Ejector Header 2.00mm SMT Type

Electrical Characteristics:

Current Rating: 1 AMP
 Insulator Resistance: 1000MΩmin. at DC 500V
 Contact Resistance: 20mΩmax. at DC 100mA
 Operating Temperature: -45°C~+105°C

Material:

Housing: 30% Glass filled PBT UL94V-0
 Contacts: Bronze
 Plating: Gold plated: 1u". over 50u" nickel
 Selective gold plated: Standard gold on mating area and tin plated on solder tail.

Features:

- * Fully shrouded provides ultimate reliability,
- * Black or gray insulator available.
- * Choices of Eject lever.

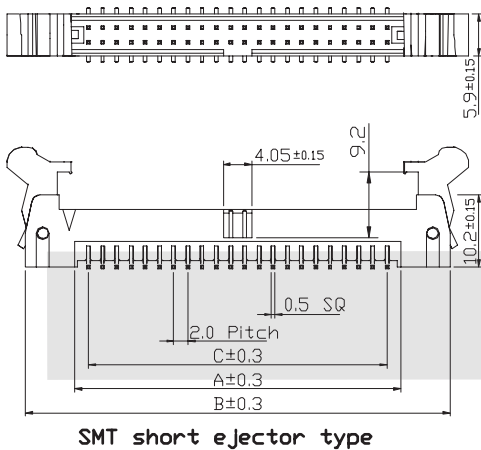
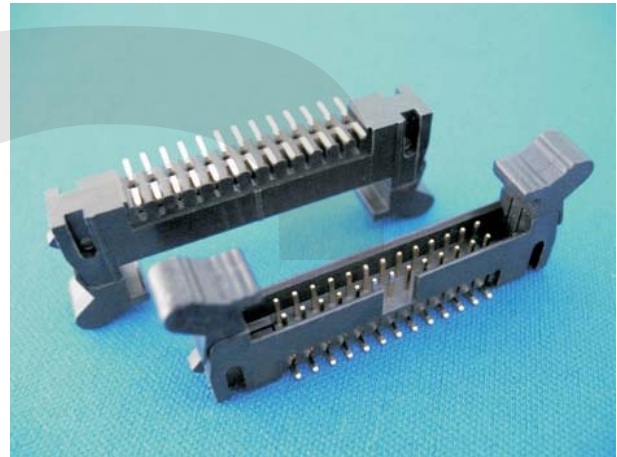

Dimension

Position	A	B
10	25.70	8.00
12	27.70	10.00
14	29.70	12.00
16	31.70	14.00
20	35.70	18.00
22	37.70	20.00
26	41.70	24.00
30	45.70	28.00
34	49.70	32.00
40	55.70	38.00
44	59.70	42.00
50	65.70	48.00
68	83.70	66.00

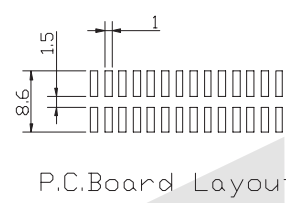
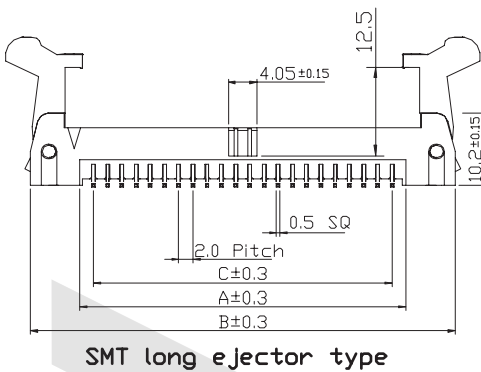

ORDER INFORMATION

Product No.: KLS1-201B-XX-T-B

Pos. No. _____ B=Black G=Gray
 Ejector Header 2.00mm _____ S=Straight Pin R=Right Pin T=SMT Pin
 Number of Contacts: XX=10-68Pin _____