

50W isolated DC-DC converter in DIP packaging
Wide input and regulated single output

FEATURES

- Wide 2:1 input voltage range
- High efficiency up to 91%
- I/O isolation test voltage 1.5K VDC
- Input under-voltage protection, output short-circuit, over-current, over-voltage protection
- Operating ambient temperature range: -40°C to +105°C
- No-load power consumption as low as 0.048W
- Six-sided metal shielding package
- Input reverse polarity protection available with chassis (A2S) or DIN-Rail mounting (A4S) version
- Industry standard pin-out
- Meets IEC62368, UL62368 standards

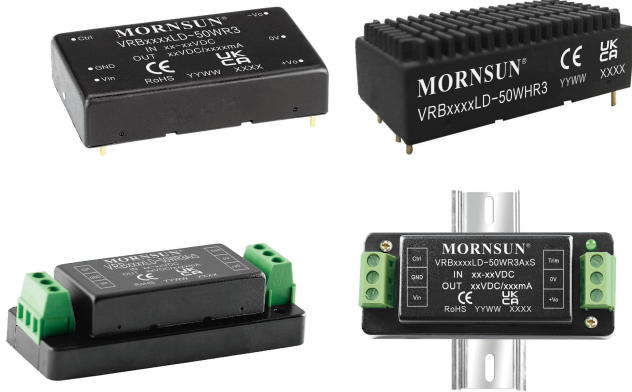

EN62368-1



BS EN62368-1

Patent Protection RoHS



VRB24_LD-50W(H)R3(A2S/A4S) series of isolated 50W DC-DC converter products with a wide 2:1 input voltage range. They feature efficiencies up to 91%, input to output isolation is tested with 1500VDC and the converter safety operate ambient temperature of -40°C to +105°C, input under-voltage protection, output over-voltage, over-current, short-circuit protection. They are ideally and widely used in applications such as industrial control, electric power, instruments and communications.

Selection Guide

Certification	Part No. ①	Input Voltage (VDC)		Output		Full Load Efficiency ④ (%) Min./Typ.	Capacitive Load (μF)Max.
		Nominal ② (Range)	Max. ③	Voltage (VDC)	Current(mA) Max./Min.		
EN/BS EN	VRB2403LD-50W(H)R3(A2S/A4S)	24 (18-36)	40	3.3	10000/500	87/90	27000
	VRB2405LD-50W(H)R3(A2S/A4S)			5	10000/500	88/90	18900
	VRB2412LD-50W(H)R3(A2S/A4S)			12	4167/208	89/91	3700
	VRB2415LD-50W(H)R3(A2S/A4S)			15	3333/167	89/91	2000
	VRB2424LD-50W(H)R3(A2S/A4S)			24	2083/104	89/91	1000

Notes:
 ① Use "H" suffix for heat sink mounting, "A2S" suffix for chassis mounting and "A4S" suffix for DIN-Rail mounting. We recommend to choose modules with a heat sink for enhanced heat dissipation and applications with extreme temperature requirements;
 ② The minimum input voltage and starting voltage of A2S and A4S Model are 1VDC higher than those of DIP package due to input reverse polarity protection function;
 ③ Exceeding the maximum input voltage may cause permanent damage;
 ④ Efficiency is measured at nominal input voltage and rated output load; efficiencies for A2S and A4S Model's is decreased by 2% due to the input reverse polarity protection circuit.

Input Specifications

Item	Operating Conditions	Min.	Typ.	Max.	Unit	
Input Current (full load / no-load)	Nominal input voltage	3.3V output	--	1528/2	1580/--	mA
		5V output	--	2315/3	2367/--	
		12V output	--	2289/5	2341/--	
		15V output	--	2289/11	2341/--	
		24V output	--	2289/4	2341/--	
Surge Voltage (1sec. max.)		-0.7	--	50	VDC	
Start-up Voltage		--	--	18		
Input Under-voltage Protection		11	13	--		
Start-up Time	Nominal input voltage & constant resistance load	--	10	120		ms

Input Filter		PI filter			
Hot Plug		Unavailable			
Ctrl*	Module on	Ctrl pin open or pulled high (TTL 3.0-12VDC)			
	Module off	Ctrl pin pulled low to GND (0-1.2VDC)			
	Input current when off	--	6	12	mA

Note: *The Ctrl pin voltage is referenced to input GND.

Output Specifications

Item	Operating Conditions	Min.	Typ.	Max.	Unit	
Voltage Accuracy	5%-100% load	--	±1	±3	%	
Linear Regulation	Input voltage variation from low to high at full load	--	±0.2	±0.5		
Load Regulation	5%-100% load	--	±0.5	±1		
Transient Recovery Time	25% load step change, nominal input voltage		--	250	500	μs
Transient Response Deviation	25% load step change, input voltage range	3.3V/5V output	--	±3	±8	%
		others	--	±3	±5	
Temperature Coefficient	Full load	--	--	±0.03	%/°C	
Ripple & Noise ^①	20MHz bandwidth, nominal input voltage, 5%-100% load	3.3V/5V output	--	120	200	mV p-p
		12V/15V output	--	180	250	
		24V output	--	240	300	
Trim	Input voltage range	90	--	110	%Vo	
Over-voltage Protection		110	140	160		
Over-current Protection		110	140	200	%Io	
Short-circuit Protection		Continuous, self-recovery				

Note: ① The "parallel cable" method is used for Ripple and Noise test, please refer to DC-DC Converter Application Notes for specific information.

General Specifications

Item	Operating Conditions	Min.	Typ.	Max.	Unit
Isolation	Input-output Electric Strength Test for 1 minute with a leakage current of 1mA max.	1500	--	--	VDC
	Input/output-housing Electric Strength Test for 1 minute with a leakage current of 1mA max.	1000	--	--	
Insulation Resistance	Input-output resistance at 500VDC	100	--	--	MΩ
Isolation Capacitance	Input-output capacitance at 100KHz/0.1V	--	2200	--	pF
Operating Temperature	See Fig. 1	-40	--	+105	°C
Storage Temperature		-55	--	+125	
Storage Humidity	Non-condensing	5	--	95	%RH
Pin Soldering Resistance Temperature	Soldering spot is 1.5mm away from case for 10 seconds	--	--	+300	°C
Vibration		10-150Hz, 5G, 0.75mm. along X, Y and Z			
Switching Frequency *	PWM mode	--	300	--	KHz
MTBF	MIL-HDBK-217F@25°C	1000	--	--	K hours

Note: *Switching frequency is measured at full load. The module reduces the switching frequency for light load (below 50%) efficiency improvement.

Mechanical Specifications

Case Material	Aluminum alloy		
Dimensions	Without heat sink	Horizontal package	50.80 x 25.40 x 11.80 mm
		A2S wiring package	76.00 x 31.50 x 21.20 mm
		A4S rail package	76.00 x 31.50 x 25.80 mm
	With heat sink	Horizontal package	51.40 x 26.20 x 16.50 mm
		A2S wiring package	76.00 x 31.50 x 25.30 mm
		A4S rail package	76.00 x 31.50 x 29.90 mm
Weight	Without heat sink	Horizontal package/A2S wiring package/A4S rail package	39g/62g/82g(Typ.)
	With heat sink	Horizontal package/A2S wiring package/A4S rail package	47g/70g/90g(Typ.)
Cooling Method	Free air convection		

Electromagnetic Compatibility (EMC)

Emissions	CE	CISPR32/EN55032	CLASS B (see Fig.3-② for recommended circuit)
	RE	CISPR32/EN55032	CLASS B (see Fig.3-② for recommended circuit)
Immunity	ESD	IEC/EN61000-4-2	Contact ±4KV perf. Criteria B
	RS	IEC/EN61000-4-3	10V/m perf. Criteria A
	EFT	IEC/EN61000-4-4	100KHz ±2KV (see Fig.3-① for recommended circuit) perf. Criteria B
	Surge	IEC/EN61000-4-5	line to line ±2KV (see Fig.3-① for recommended circuit) perf. Criteria B
	CS	IEC/EN61000-4-6	10 Vr.m.s perf. Criteria A

Typical Characteristic Curves

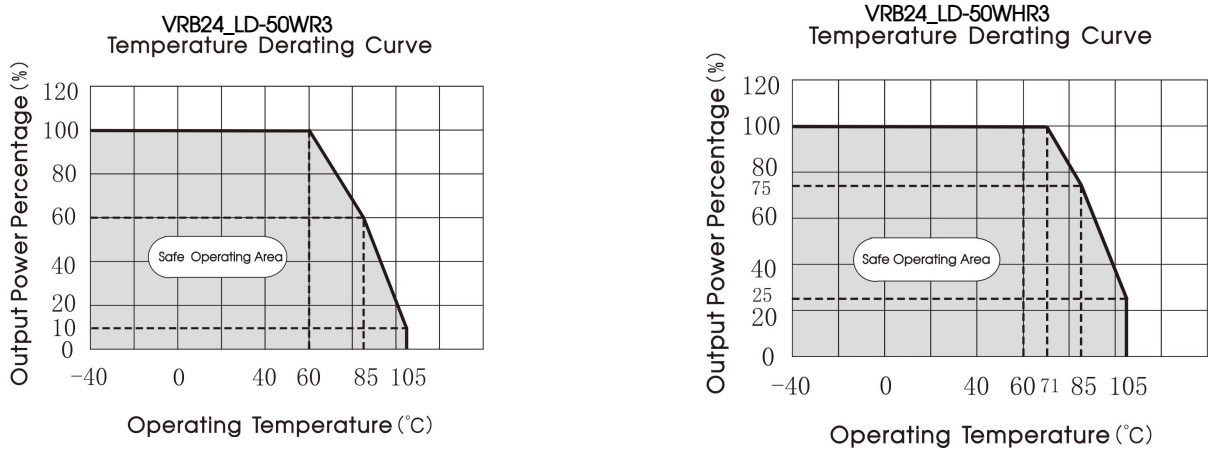

Fig. 1

Design Reference

1. Typical application

All DC-DC converters of this series are tested before delivery using the recommended circuit shown in Fig. 2.

Input and/or output ripple can be further reduced by appropriately increasing the input & output capacitor values C_{in} and C_{out} and/or by selecting capacitors with a low ESR (equivalent series resistance). Also make sure that the capacitance is not exceeding the specified max. capacitive load value of the product.

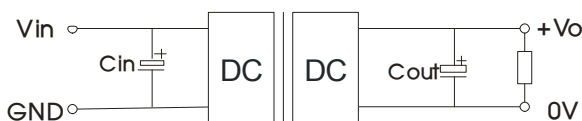

Fig. 2

Vout (VDC)	Cin (μF)	Cout (μF)
3.3/5	100	470/10V
12/15		100/25V
24		47/50V

2. EMC compliance circuit

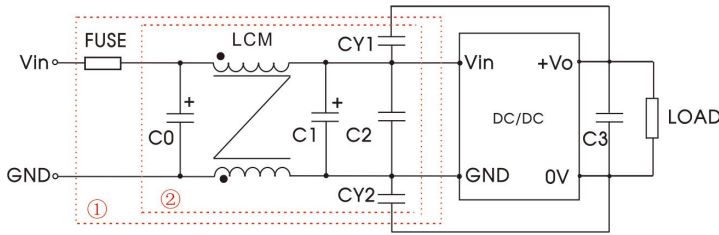

Fig. 3

Notes: We use Part ① in Fig. 3 for Immunity tests and Part ② for Emissions test. Selecting based on needs.

Parameter description:

Model	Vin:24V
FUSE	T/4A/250VAC
C0	680µF/50V
LCM	2.2mH, recommended to use MORNSUN P/N: FL2D-30-222
C1	330µF/50V
C2	4.7µF/50V
CY1, CY2	Y1 Safety capacitor 2.2nF/250VAC
C3	Refer to the Cout in Fig.2

3. Trim function for output voltage adjustment (open if unused)

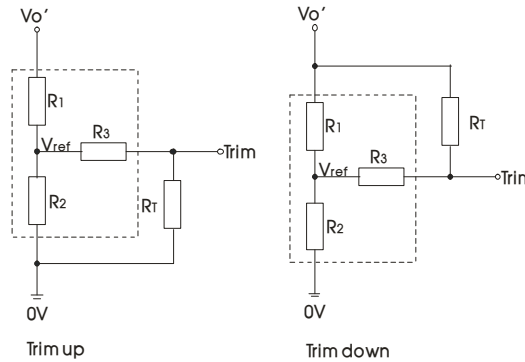

TRIM resistor connection (dashed line shows internal resistor network)

Calculating Trim resistor values:

$$\begin{aligned} \text{up: } R_T &= \frac{\alpha R_2}{R_2 - \alpha} \cdot R_3 & \alpha &= \frac{V_{ref}}{V_{o'} - V_{ref}} \cdot R_1 \\ \text{down: } R_T &= \frac{\alpha R_1}{R_1 - \alpha} \cdot R_3 & \alpha &= \frac{V_{o'} - V_{ref}}{V_{ref}} \cdot R_2 \end{aligned}$$

R_T is Trim resistance
 α is a self-defined parameter, with no real meaning.

Vout(V)	Vout adjustable value(V)	RT(KΩ)	R1(KΩ)	R2(KΩ)	R3(KΩ)	Vref(V)
3.3	Up: 3.63	15.0	4.83	2.87	4.7	1.24
	Down: 2.97	18.7	4.83	2.87	4.7	1.24
5	Up: 5.5	13.3	2.97	2.87	4.7	2.5
	Down: 4.5	5.4	2.97	2.87	4.7	2.5
12	Up: 13.2	7.6	10.90	2.87	15	2.5
	Down: 10.8	60.7	10.90	2.87	15	2.5
15	Up: 16.5	8.9	14.35	2.87	15	2.5
	Down: 13.5	90.2	14.35	2.87	15	2.5
24	Up: 26.4	21.6	24.77	2.87	5.1	2.5
	Down: 21.6	185.9	24.77	2.87	5.1	2.5

4. The products do not support parallel connection of their output

5. For additional information please refer to DC-DC converter application notes on

www.mornsun-power.com

VRB24_LD-50WR3 Dimensions and Recommended Layout

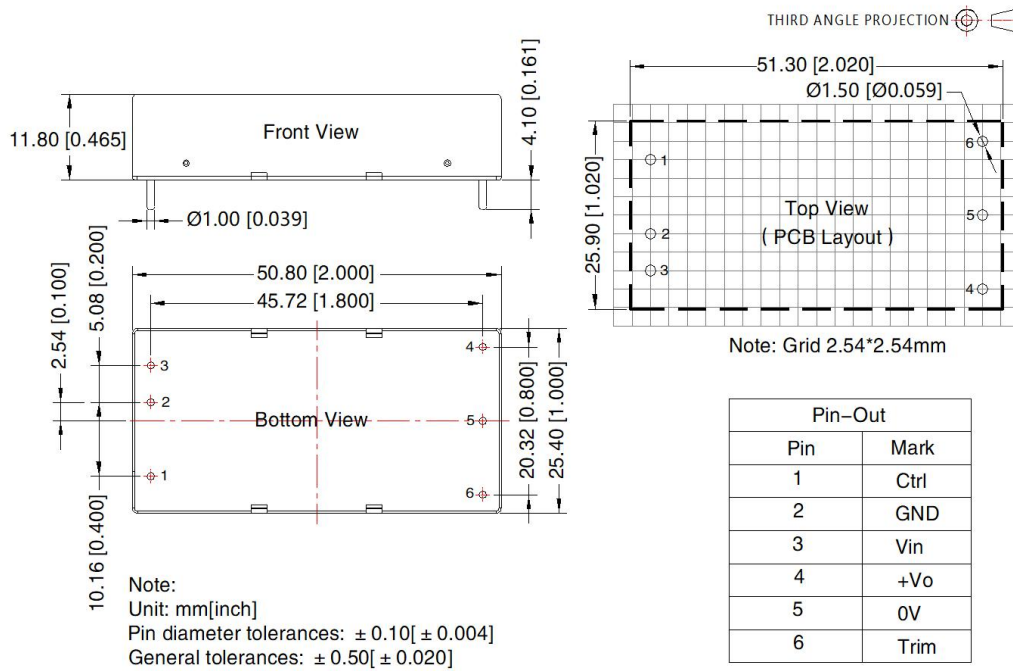

VRB24_LD-50WR3A2S Dimensions and Recommended Layout

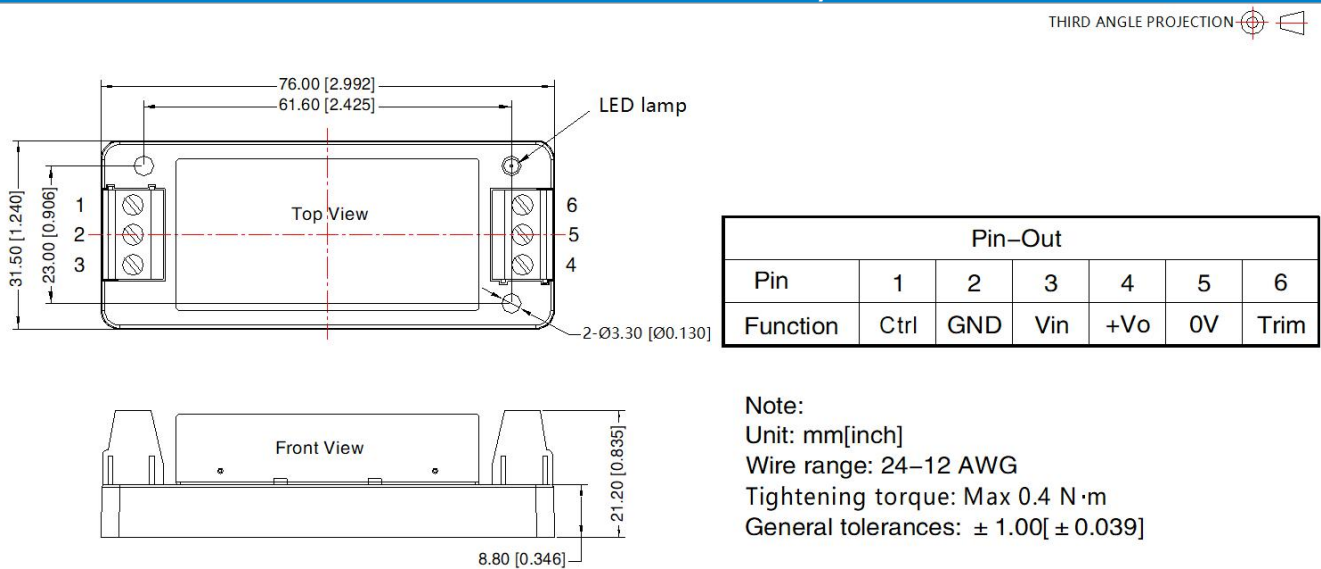

VRB24_LD-50WR3A4S Dimensions and Recommended Layout

THIRD ANGLE PROJECTION 

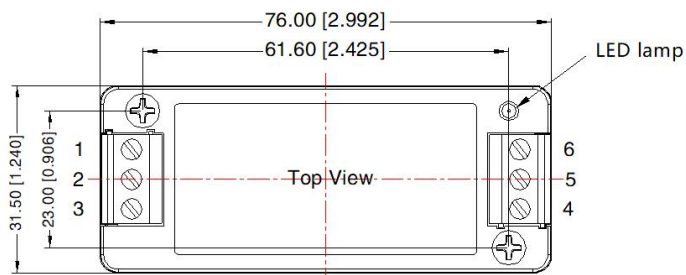

Pin-Out						
Pin	1	2	3	4	5	6
Mark	Ctrl	GND	Vin	+Vo	0V	Trim

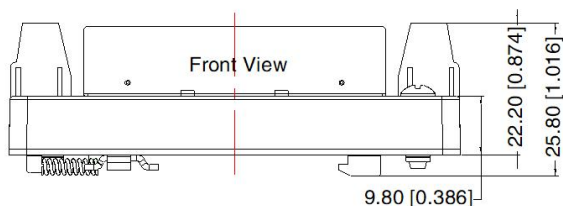

Note:
Unit: mm[inch]
Mounting rail: TS35
Wire range: 24-12 AWG
Tightening torque: Max 0.4 N·m
General tolerances: ± 1.00 [± 0.039]

VRB24_LD-50WHR3 Dimensions and Recommended Layout

THIRD ANGLE PROJECTION 

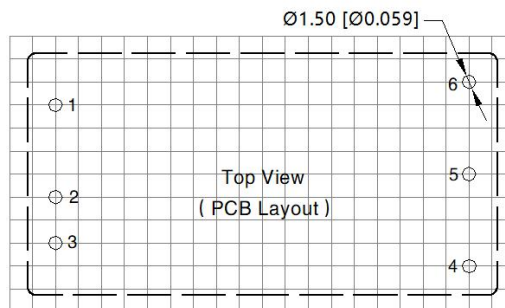
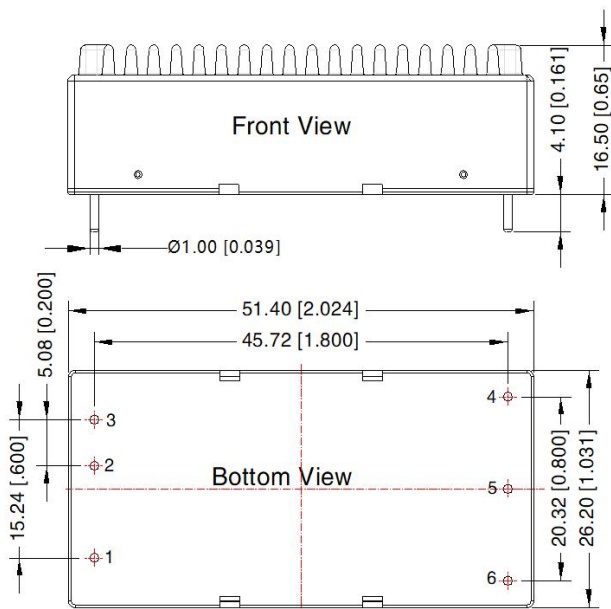

Note: Grid 2.54*2.54mm

Pin-Out	
Pin	Mark
1	Ctrl
2	GND
3	Vin
4	+Vo
5	0V
6	Trim

Note:
Unit: mm[inch]
Pin diameter tolerances: ± 0.10 [± 0.004]
General tolerances: ± 0.50 [± 0.020]

VRB24_LD-50WHR3A2S Dimensions and Recommended Layout

THIRD ANGLE PROJECTION 

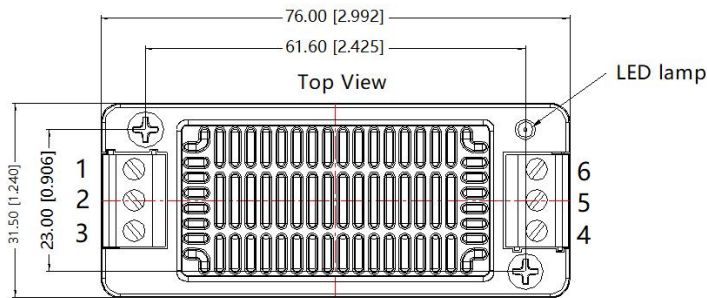

Pin-Out						
Pin	1	2	3	4	5	6
Function	Ctrl	GND	Vin	+Vo	0V	Trim

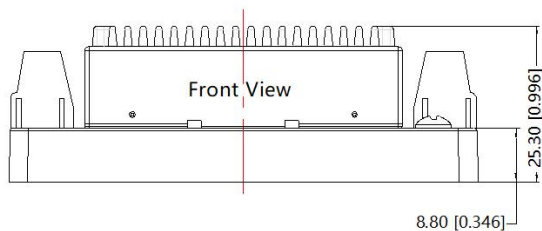

Note:
Unit: mm[inch]
Mounting rail: TS35
Wire range: 24-12 AWG
Tightening torque: Max 0.4 N·m
General tolerances: $\pm 1.00[\pm 0.039]$

VRB24_LD-50WHR3A4S Dimensions and Recommended Layout

THIRD ANGLE PROJECTION 

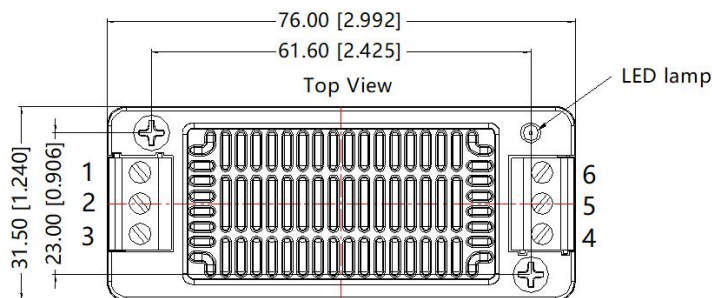

Pin-Out						
Pin	1	2	3	4	5	6
Function	Ctrl	GND	Vin	+Vo	0V	Trim

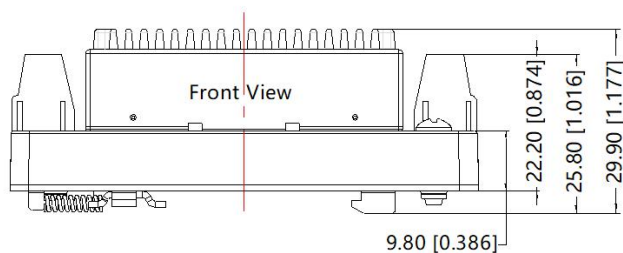

Note:
Unit: mm[inch]
Mounting rail: TS35
Wire range: 24-12 AWG
Tightening torque: Max 0.4 N·m
General tolerances: $\pm 1.00[\pm 0.039]$

Note:

1. For additional information on Product Packaging please refer to www.mornsun-power.com. The Packaging bag number of Horizontal packaging: 58200035(without heat sink), 58200051(with heat sink), A2S/A4S packaging number: 58220022(without heat sink and with heat sink);
2. It is recommended to use at more than 10% load. If the load is lower than 10%, the ripple of the product may exceed the specifications, but the reliability of the product is not affected.
3. The maximum capacitive load offered were tested at input voltage range and full load;
4. Unless otherwise specified, parameters in this datasheet were measured under the conditions of $T_a=25^{\circ}\text{C}$, humidity<75%RH with nominal input voltage and rated output load;
5. All index testing methods in this datasheet are based on company corporate standards;
6. We can provide product customization service, please contact our technicians directly for specific information;
7. Products are related to laws and regulations: see "Features" and "EMC";
8. Our products shall be classified according to ISO14001 and related environmental laws and regulations, and shall be handled by qualified units.

Mornsun Guangzhou Science & Technology Co., Ltd.

Address: No. 5, Kehui St. 1, Kehui Development Center, Science Ave., Guangzhou Science City, Huangpu District, Guangzhou, P. R. China
Tel: 86-20-38601850 Fax: 86-20-38601272 E-mail: info@mornsun.cn www.mornsun-power.com