

■ 电流检测厚膜片式固定电阻器

Current Sensing Thick Film Chip Fixed Resistor

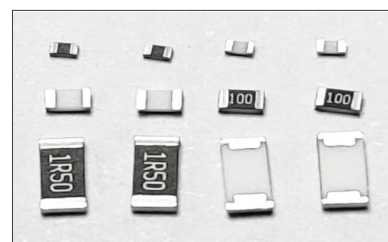

◆ 特点 Features

- * 适于作电流探测用电阻器
Current detecting resistors for power supply, motor circuits, etc
- * 符合RoHS指令要求
Compliant with RoHS directive
- * 符合无卤素要求
Halogen free requirement

◆ 应用领域 Applications

开关电源、音响设备的过电流保护、电压调节器、电源转换器、充电器、LED灯驱动电源、便携式设备等。
 Switching Power Supply, Over Current Protection in Audio Application, Voltage Regulation, Module(VRM), DC-DC Converter, Charger, LED Lamp Devices, Portable Devices, etc.

◆ 品名构成 Type Designation

产品代号 Product Code	额定功率代号 Power Rating Code		封装尺寸 Dimensions		电阻温度系数代号 T.C.R Code			电阻值代号 Resistance Value Code	阻值误差精度代号 Resistance Tolerance Code		包装方式代号 Packaging Style Code		
	代号 Code	额定功率系列 Power rating	代号 Code	型号 Type	型号 Type	代号 Code	T.C.R (ppm/°C)		代号 Code	误差精度 Tolerance	代号 Code	包装方法 Packaging Style	
电流检测厚膜片式固定电阻器 Current Sensing Thick Film Chip Fixed Resistor	C	1/16W	02	0402	0402	U	± 400	单位Ω，小数点用R表示； 单位mΩ，小数点用M表示； Units:Ω Decimal point should be expressed by "R" ; Units: mΩ Decimal point should be expressed by "M" 例如Example: R005=0.005Ω R100=0.100Ω R047=0.047Ω 6M50=6.50mΩ	F	± 1%	T	编带包装 Tape & Reel	
	D	1/10W	03	0603	0603	M	± 500		G	± 2%			
	E	1/8W	05	0805	0805	R	± 700		H	± 3%			
	Y	1/6W	06	1206	1210	1210	Q		± 800	J			± 5%
	Q	1/5W	10	2010	2010	2010	S		± 1000				
	R	1/3W	12	2512	2512	2512	Y		± 1500			C	塑料袋散装 Case
	F	1/4W											
	H	3/4W											
	G	1/2W											
	J	1W											
L	2W												

- 注：1、不同厂家的超低阻产品其工艺及技术参数可能会略有差异，建议客户索样评估使用的可行性；不同厂家的超低阻产品不建议直接替换使用，我司不承担因直接替换使用而带来的经济损失。
 The process and technical parameters of ultra-low resistance products from different manufactures may be slightly different, so it is suggested that customers ask for samples to evaluate the feasibility of use; the ultra-low resistance products from different manufactures are not recommended to be replaced directly, and our company will not bear the economic losses caused by the direct replacement.
- 2、阻值≤50mΩ的超低阻产品，如果必须选用厚膜超低阻产品，选型时请联系原厂。
 For the resistance value ≤ 50mΩ, if thick film ultra-low resistance products must be selected, please contact our customer service team for selection.

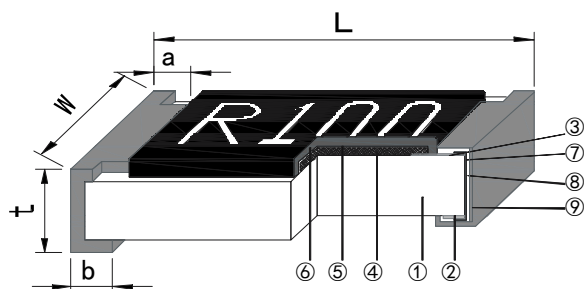
◆ 结构 Construction

- ① 陶瓷基板 Ceramic Substrate
- ② 背电极 Bottom Electrode
- ③ 面电极 Top Electrode
- ④ 电阻体 Resistor Layer
- ⑤ 一次保护 Primary Overcoat
- ⑥ 二次保护 Secondary Marking
- ⑦ 端电极 Edge Electrode
- ⑧ 中间电极 Barrier Layer
- ⑨ 外部电极 External Electrode

◆ 规格尺寸 Dimensions

单位 Unit:mm

型号 Type	L	W	t	a	b
0402	1.00±0.05	0.50±0.05	0.30±0.05	0.20±0.10	0.25±0.10
0603	1.60±0.10	0.80±0.10	0.45±0.10	0.30±0.20	0.30±0.20
0805	2.00±0.10	1.25±0.15	0.50±0.10	0.30±0.20	0.40±0.20
1206	3.20±0.20	1.60±0.15	0.55±0.10	0.50±0.20	0.50±0.20
1210	3.20±0.20	2.50±0.20	0.55±0.10	0.50±0.20	0.50±0.20
2010	5.00±0.20	2.50±0.20	0.55±0.10	0.60±0.20	0.60±0.20
2512	6.30±0.20	3.20±0.20	0.55±0.10	0.60±0.20	0.60±0.20
*2512	6.30±0.20	3.20±0.20	0.55±0.10	0.35±0.20	1.85±0.20

*2512: 为 2512 (2W) 特殊功率产品 special power product

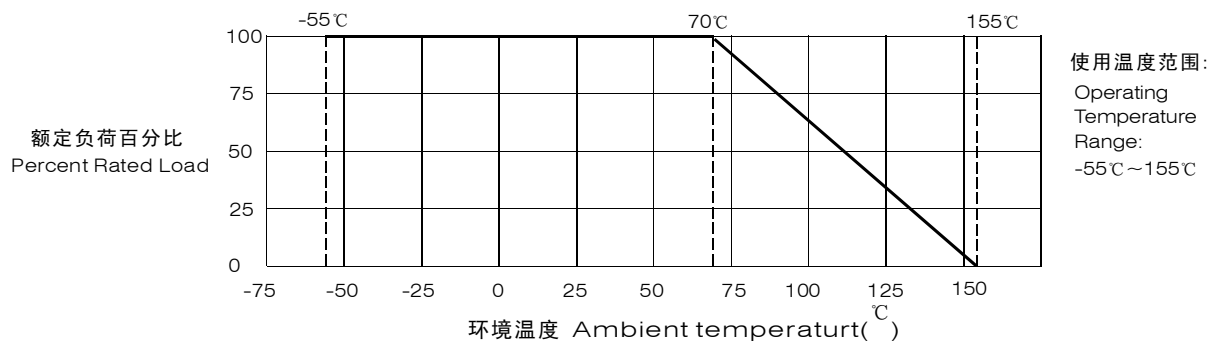
◆ 负荷下降曲线 Derating Curve

注: 当电阻使用的环境温度超过70°C时, 其额定负荷(额定功率)按上述曲线下降。

Note: For resistors operated in ambient over 70°C, rated load (rated power) shall be derated in accordance with the above figure.

◆ 额定值 Ratings

型号 Type	70℃下额定功率 Rating Power at 70℃ (W)			元件极限电压 Limiting Element Voltage (V)	最大过负荷电压 Max.Overload Voltage (V)	阻值范围 Resistance Range (mΩ)	电阻温度系数 T.C.R (PPM/℃)			
							± 1%	± 2%	± 3%	± 5%
0402	C:1/16	Y:1/6		0.41	1.03	100~199	R: ± 700			
						200~499	M: ± 500			
						500~999	U: ± 400			
0603	D:1/10	E:1/8	Q:1/5	0.45	1.13	10~32.9	Y: ± 1500			
						33~67.9	S: ± 1000			
						68~99.9	Q: ± 800			
						100~199	R: ± 700	S: ± 1000		
						200~499	M: ± 500			
						500~999	U: ± 400			
0805	E:1/8	F:1/4		0.50	1.25	0805 1206 1210 2010 2512	10~19.9	Y: ± 1500		
1206	F:1/4	G:1/2		0.71	1.78		20~49.9	S: ± 1000		
1210	R:1/3	G:1/2		0.71	1.78		50~99.9	Q: ± 800		
2010	H:3/4	J:1		1.00	2.50		100~199	R: ± 700	S: ± 1000	
							200~499	M: ± 500		
2512	J:1	L:2		1.14	2.85		500~999	U: ± 400		

注 Note:

- 1、电压为直流或交流有效值。
Voltage of DC or AC RMS value.
- 2、 $E = \sqrt{P \times R}$ 或元件极限电压两者中的较小值。
 $E = \sqrt{P \times R}$ or Limiting element voltage whichever is lower.
E: 额定电压 Rated voltage(V)
P: 额定功率 Rated power(W)
R: 标称阻值 Normal resistance(Ω)

◆ 特性 Characteristics

项目 Item	标准 Specifications	测试方法 (IEC60115-1) Test Methods (IEC60115-1)
可焊性 Solderability	可焊面积 ≥ 95% 95% Cover Min	IEC 60115-1 4.17 245℃ ± 5℃ 锡槽, 保持3s ± 0.3s. Lead-free solder bath at 245℃ ± 5℃ for 3s ± 0.3s.
耐焊接热 Resistance to Soldering Heat	无可见损伤 No mechanical damage $\Delta R \leq \pm(1.0\%R + 0.5m\Omega)$	IEC 60115-1 4.18 270℃ ± 5℃ 锡槽, 保持10s ± 1s. Lead-free solder bath at 270℃ ± 5℃ for 10s ± 1s.
基板弯曲试验 Substrate Bending Test	无可见损伤 No mechanical damage $\Delta R \leq \pm(1.0\%R + 0.5m\Omega)$	IEC 60115-1 4.33 弯曲距离(Bending distance): 0402、0603、0805:5mm; 1206、1210:4mm; 2010、2512:2mm 保持时间(Duration): 60s ± 5s.

◆ 特性 Characteristics

(续上页 Continue)

项目 Item	标准 Specifications	测试方法 (IEC60115-1) Test Methods (IEC60115-1)
电阻温度系数 T.C.R	在规定值内 Within specified T.C.R	IEC 60115-1 4.8 +20℃/-55℃/+20℃/+125℃/+20℃
温度快速变化 Rapid Change of Temperature	无可见损伤 No mechanical damage $\Delta R \leq \pm (1.0\%R + 0.5m\Omega)$	IEC 60115-1 4.19 -55℃(30分钟) ~ 常温(5分钟) ~ 155℃(30分钟) 300个循环。 -55℃(30min) ~ normal temperature(5min) ~ 155℃(30min) 300 cycles.
短时间过载 Short Time Overload	无可见损伤 No mechanical damage $\Delta R \leq \pm (1.0\%R + 0.5m\Omega)$	IEC 60115-1 4.13 2.5倍额定电压, 持续5秒。 2.5 times rated voltage for 5s.
稳态湿热 Damp Heat Steady State	无可见损伤 No mechanical damage $\Delta R \leq \pm (3.0\%R + 0.5m\Omega)$	IEC 60115-1 4.24 40℃ ± 2℃, 93% ± 3%RH, 1000h, 额定电压, 通1.5小时/断0.5小时。 40℃ ± 2℃, 93% ± 3%RH, 1000h, rated voltage for 1.5h ON/0.5h OFF.
剪切力试验 Shear Test	无可见损伤 No mechanical damage	IEC 60115-1 4.32 施加力 (Applying force):0402、0603:5N;0805:9N;1206、1210:25N; 2010\2512:45N 保持时间(Duration):10s ± 1s
70℃耐久性 Endurance at 70℃	无可见损伤 No mechanical damage $\Delta R \leq \pm (2.0\%R + 0.5m\Omega)$	IEC 60115-1 4.25.1 70℃ ± 2℃, 1000小时, 额定电压, 通1.5小时/断0.5小时。 70℃ ± 2℃, 1000h, rated voltage for 1.5h ON/0.5h OFF.
上限类别温度耐久性 Endurance at Upper Category Temperature	无可见损伤 No mechanical damage $\Delta R \leq \pm (1.0\%R + 0.5m\Omega)$	IEC 60115-1 4.25.3 155℃ ± 2℃, 1000小时 155℃ ± 2℃, 1000h
低温负载 Operation at Low Temperature	无可见损伤 No mechanical damage $\Delta R \leq \pm (1.0\%R + 0.5m\Omega)$	IEC 60115-1 4.36 -55℃ ± 5℃, 无负载1小时, 额定电压45分钟, 无负载15分钟。 -55℃ ± 5℃, 1h without load, rated voltage for 45min, 15min without load.
绝缘电阻 Insulation Resistance	1000MΩ Min	IEC 60115-1 4.6 在电极与基片间施加100V±15V直流电压, 保持1分钟, 然后测绝缘电阻值。 Apply DC 100V ± 15V between substrate and terminations for 1min, then check insulation resistance.
耐电压 Voltage Proof	无击穿或飞弧 No breakdown or flashover	IEC 60115-1 4.7 在电极与基片间以大约100V/s的速率施加有效值为最大过负荷电压的交流电压, 保持60s±5s。 最大过负荷电压: 0402、0603: 100V;0805:300V;1206、1210、2010、 2512:400V Apply max. overload voltage of AC RMS at a rate of approximately 100V/s between substrate and terminations for 60s ± 5s. Max. Overload Voltage (V):0402、0603: 100V;0805:300V; 1206、1210、2010、2512:400V
耐溶剂 Component Solvent Resistance	无可见损伤 No mechanical damage $\Delta R \leq \pm (1.0\%R + 0.5m\Omega)$	IEC 60115-1 4.29 异丙醇 (IPA), 23℃ ± 5℃, 浸10小时。 Iso-propyl alcohol (IPA), 23℃ ± 5℃, 10h.

◆ 阻值标准测量位置 Standard Measuring Position for Resistance Value

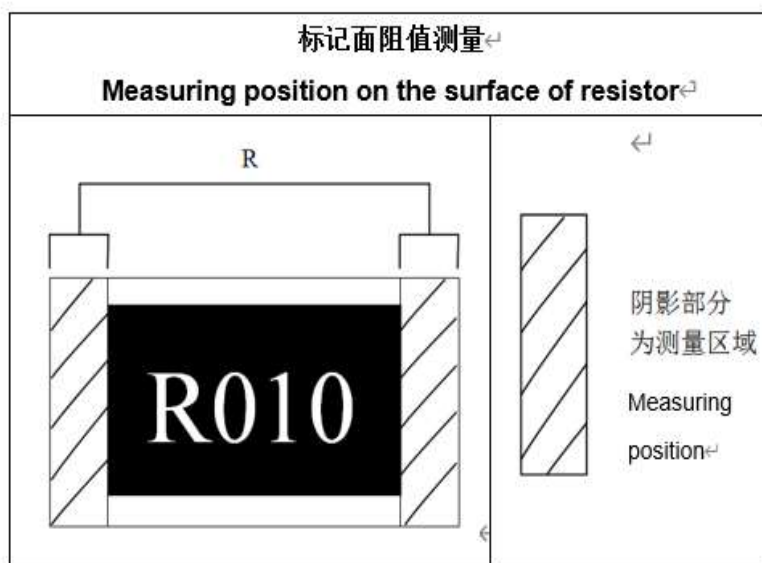

◆ 推荐焊盘尺寸 Recommend Solder Pad Size

单位 unit: mm

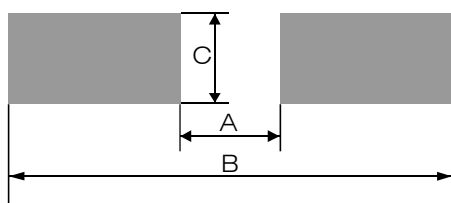

厚膜电阻 Thick Film Resistor			
型号Type	A	B	C
0402	0.45	1.45	0.60
0603	0.80	2.50	0.95
0805	1.05	3.25	1.40
1206	1.90	4.50	1.75
1210	2.00	4.60	2.70
2010	3.50	6.50	2.70
2512	4.80	7.80	3.40
*2512 (2W)	2.60	7.80	3.40

注：电阻焊接后，电阻值可能因焊盘面积、焊盘间距、焊锡量的差别而发生变化。顾客在设计电路及选型时，必须充分而全面的考虑及评判适用性。

After soldering, the resistance value may change due to the difference of pad area, pad spacing and solder quantity. When designing circuits and selecting models, customers must comprehensively consider and evaluate the applicability.

◆ 包装 Packaging

包装方式见附录 Packaging can refer to the Appendix.

附录 Appendix

◆ 推荐焊盘尺寸 Recommend Solder Pad Size

- 片式固定电阻器 Chip fixed resistor

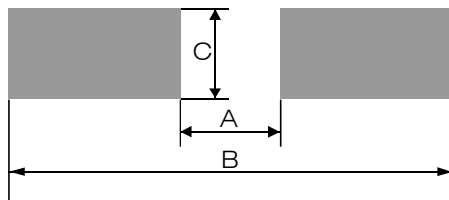

单位 unit: mm

厚膜电阻及薄膜电阻 Thick Film Resistor and Thin Film Resistor			
型号 Type	A	B	C
01005	0.17 ± 0.03	0.60 ± 0.03	0.22 ± 0.03
0201	0.23 ± 0.05	0.84 ± 0.05	0.38 ± 0.05
0402	0.45 ± 0.05	1.45 ± 0.05	0.60 ± 0.05
0603	0.80 ± 0.05	2.50 ± 0.05	0.95 ± 0.05
0805	1.05 ± 0.1	3.25 ± 0.1	1.40 ± 0.1
1206	1.90 ± 0.1	4.50 ± 0.1	1.75 ± 0.1
1210	2.00 ± 0.1	4.60 ± 0.1	2.70 ± 0.1
2010	3.50 ± 0.1	6.50 ± 0.1	2.70 ± 0.1
2512	4.80 ± 0.1	7.80 ± 0.1	3.40 ± 0.1
2512 (2W)	2.70 ± 0.1	7.80 ± 0.1	3.60 ± 0.1

- 厚膜片式网络电阻器 Thick film chip network resistor

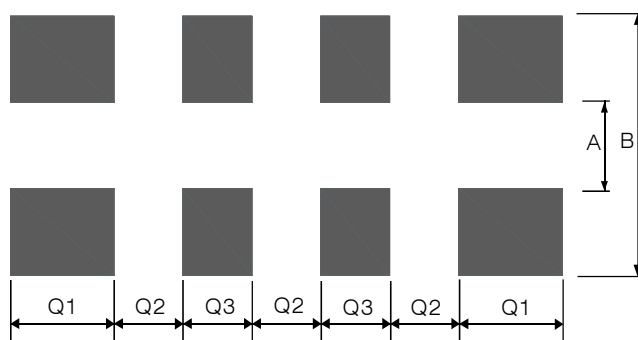

RCMY08 / RCMT08 / RCML08

单位 unit: mm

型号 Type	A	B	Q1	Q2	Q3
RCMY08	0.30 ± 0.05	0.90 ± 0.05	0.20 ± 0.05	0.20 ± 0.05	0.20 ± 0.05
RCMT08	0.38 ± 0.05	1.60 ± 0.05	0.40 ± 0.05	0.20 ± 0.05	0.30 ± 0.05
RCML08	0.80 ± 0.05	2.70 ± 0.05	0.60 ± 0.05	0.40 ± 0.05	0.40 ± 0.05

◆ 包装 Packaging
● 纸带编带 Paper Taping

适用于01005、0201、0402、RCMY08、RCMT08；

For 01005、0201、0402、RCMY08、RCMT08；

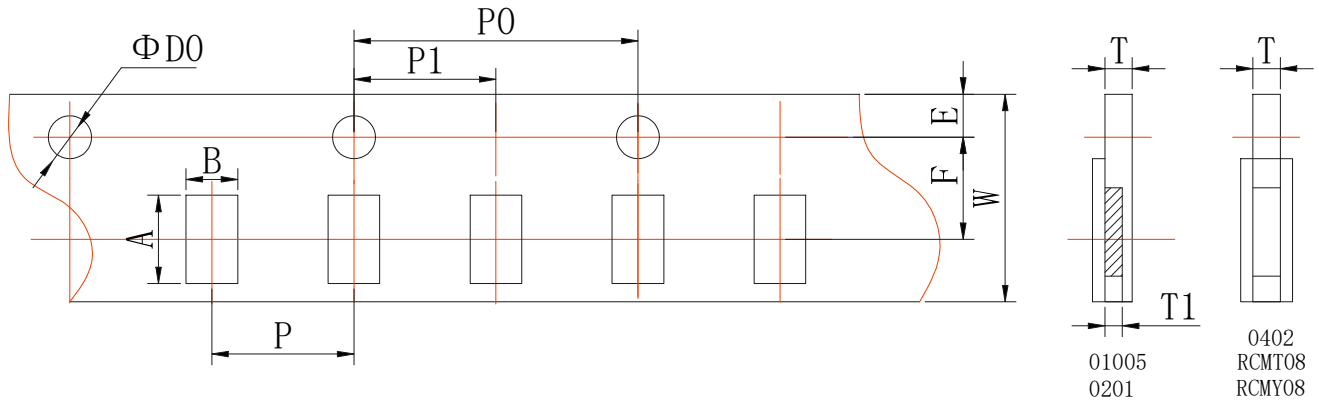

单位 unit: mm

型号 Type	A	B	W	F	E
01005	0.45 ± 0.02	0.25 ± 0.02	8.00 ± 0.02	3.50 ± 0.05	1.75 ± 0.05
0201	0.70 ± 0.10	0.40 ± 0.10	8.00 ± 0.20	3.50 ± 0.05	1.75 ± 0.10
0402	1.20 ± 0.10	0.70 ± 0.10	8.00 ± 0.20	3.50 ± 0.05	1.75 ± 0.10
RCMY08	1.57 ± 0.05	0.77 ± 0.05	8.00 ± 0.20	3.50 ± 0.05	1.75 ± 0.10
RCMT08	2.20 ± 0.10	1.20 ± 0.10	8.00 ± 0.20	3.50 ± 0.05	1.75 ± 0.10

单位 unit: mm

型号 Type	P	P0	P1	$\Phi D0$	T1	T
01005	2.00 ± 0.05	4.00 ± 0.10	2.00 ± 0.05	1.55 ± 0.02	0.17 ± 0.02	0.31 ± 0.02
0201	2.00 ± 0.05	4.00 ± 0.10	2.00 ± 0.05	1.50 ± 0.10	0.28 ± 0.04	0.42 ± 0.05
0402	2.00 ± 0.05	4.00 ± 0.10	2.00 ± 0.05	1.50 ± 0.10	/	0.42 ± 0.05
RCMY08	2.00 ± 0.05	4.00 ± 0.10	2.00 ± 0.05	1.50 ± 0.10	/	0.60 ± 0.10
RCMT08	2.00 ± 0.10	4.00 ± 0.10	2.00 ± 0.05	1.50 ± 0.10	/	0.60 ± 0.10

适用于0603、0805、1206、1210、RCML08；

For 0603、0805、1206、1210、RCML08；

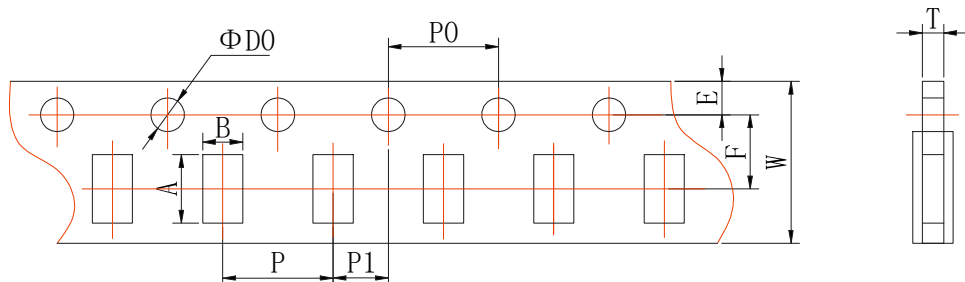

单位 unit: mm

型号 Type	A	B	W	F	E
0603	1.85 ± 0.10	1.10 ± 0.10	8.00 ± 0.20	3.50 ± 0.05	1.75 ± 0.10
0805	2.35 ± 0.10	1.65 ± 0.10	8.00 ± 0.20	3.50 ± 0.05	1.75 ± 0.10
1206	3.50 ± 0.20	1.90 ± 0.20	8.00 ± 0.20	3.50 ± 0.05	1.75 ± 0.10
1210	3.50 ± 0.20	2.80 ± 0.20	8.00 ± 0.20	3.50 ± 0.05	1.75 ± 0.10
RCML08	3.50 ± 0.20	1.90 ± 0.20	8.00 ± 0.20	3.50 ± 0.05	1.75 ± 0.10

单位 unit: mm

型号 Type	P	P0	P1	ΦD0	T	
					厚膜电阻及薄膜电阻 Thick Film Resistor and Thin Film Resistor	合金片式固定电阻 Metal Foil Resistor
0603	4.00 ± 0.10	4.00 ± 0.10	2.00 ± 0.05	1.50 ± 0.10	0.60 ± 0.10	0.75 ± 0.10
0805	4.00 ± 0.10	4.00 ± 0.10	2.00 ± 0.05	1.50 ± 0.10	0.75 ± 0.10	0.95 ± 0.10
1206	4.00 ± 0.10	4.00 ± 0.10	2.00 ± 0.05	1.50 ± 0.10	0.75 ± 0.10	0.95 ± 0.10
1210	4.00 ± 0.10	4.00 ± 0.10	2.00 ± 0.05	1.50 ± 0.10	0.75 ± 0.10	---
RCML08	4.00 ± 0.10	4.00 ± 0.10	2.00 ± 0.05	1.50 ± 0.10	0.75 ± 0.10	---

● 塑料带编带 Embossed Taping

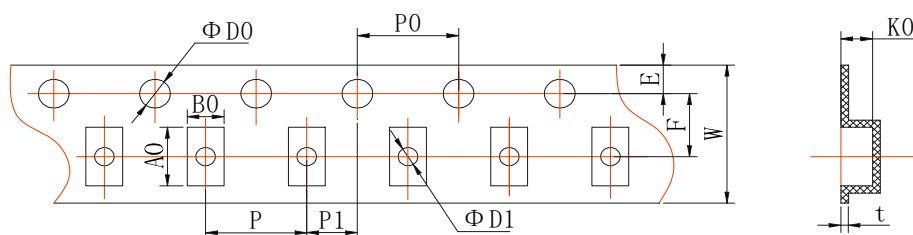
 适用于2010、2512:
 For 2010、2512:

单位 unit: mm

型号 Type	A0	B0	W	F	E	t
2010	5.50 ± 0.15	2.82 ± 0.15	12.00 ± 0.10	5.50 ± 0.10	1.75 ± 0.10	0.25 ± 0.05
2512	6.78 ± 0.15	3.45 ± 0.15	12.00 ± 0.10	5.50 ± 0.10	1.75 ± 0.10	0.25 ± 0.05

单位 unit: mm

型号 Type	P	P0	P1	ΦD0	ΦD1	K0	
						厚膜电阻及薄膜电阻 Thick Film Resistor and Thin Film Resistor	合金片式固定电阻 Metal Foil Resistor
2010	4.00 ± 0.10	4.00 ± 0.10	2.00 ± 0.05	$1.50 \pm 0.10 / -0$	1.50 ± 0.10	0.84 ± 0.10	0.84 ± 0.10
2512	4.00 ± 0.10	4.00 ± 0.10	2.00 ± 0.05	$1.50 \pm 0.10 / -0$	1.50 ± 0.10	0.81 ± 0.10	1.00 ± 0.10

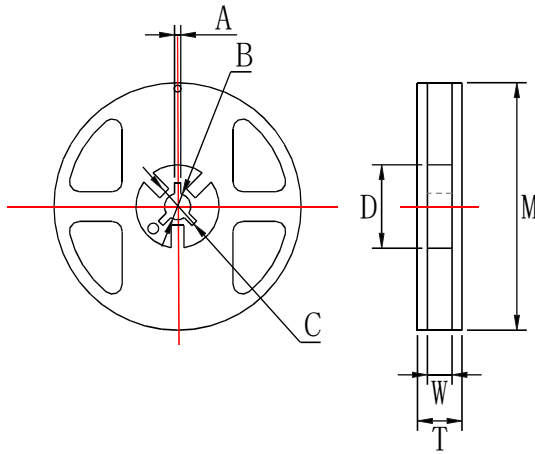
● 卷盘 Reel

单位 unit: mm

型号 Type	M	W	T	A	B	C	D
01005、0201 0402、0603 0805、1206 1210、RCMY08、 RCMT08、RCML08	178±2.0	9.5±1.0	12.5±1.5	2.0±0.5	13.0±0.5	21.0±0.5	58.0±2.0
2010、2512	178±2.0	13.0±0.5	15.5±1.5	2.0±0.5	13.0±0.5	21.0±0.5	57.0±2.0

● 编带包装能力 Taping Ability

面带拉力 Top tape peel strength

面带拉力强度为11~70g(0.1N~0.7N) , 速度: 300mm/min,经下列试验后不允许有破裂断带现象。

Peel strength is 11~70g (0.1N~0.7N),with speed of 300mm/min,and should not have flash and tear after peeling.

测试方法Test method:

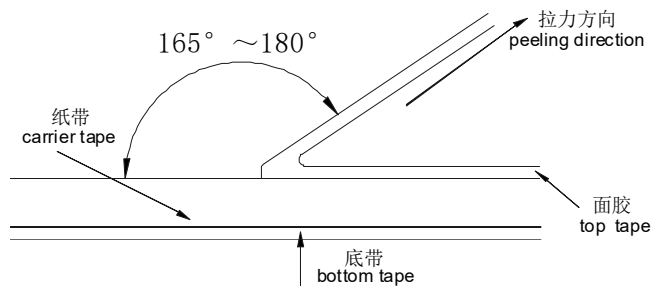

电阻松动自如, 无粘面胶带、底胶带现象。

Resistor is free, no sticking to top tape and bottom tape.

电阻易从纸带中取出, 且晶片孔无机械损伤。

Resistor is easy to take out from carrier tape and chip hole have no mechanical damage.

● 包装数量 Packaging Quantity

包装方法 Packaging style	编带 Tape & reel					塑料袋散装 Case		
型号 Type	01005	0201	0402 RCMY08, RCMT08	0603, 0805 1206, 1210 RCML08	2010 2512	01005 0201 0402	0603, 0805 1206, RCMY08, RCMT08, RCML08	1210 2010 2512
数量 Quantity(pcs)	20000	15000	10000	5000	4000	≤50000	≤10000	≤4000

◆ IEC E-24、E-96系列电阻值代码对照表
IEC E-24、E-96 Series Resistance Cross-reference List
● E-24 系列 E-24 series($\times 10^n\Omega$)

 (单位 unit: 0.001 Ω 、0.01 Ω 、0.1 Ω 、1 Ω 、10 Ω 、100 Ω 、1k Ω 、10k Ω 、100k Ω 、1M Ω 、10M Ω 、100M Ω 、1000M Ω)

表一 Table One:

1.0	1.5	2.2	3.3	4.7	6.8
1.1	1.6	2.4	3.6	5.1	7.5
1.2	1.8	2.7	3.9	5.6	8.2
1.3	2.0	3.0	4.3	6.2	9.1

● E-96系列 E-96 series ($\times 10^n\Omega$)

 (单位unit: 0.001 Ω 、0.01 Ω 、0.1 Ω 、1 Ω 、10 Ω 、100 Ω 、1k Ω 、10k Ω 、100k Ω 、1M Ω 、10M Ω 、100M Ω 、1000M Ω)

表二 Table Two:

1.00	1.33	1.78	2.37	3.16	4.22	5.62	7.50
1.02	1.37	1.82	2.43	3.24	4.32	5.76	7.68
1.05	1.40	1.87	2.49	3.32	4.42	5.90	7.87
1.07	1.43	1.91	2.55	3.40	4.53	6.04	8.06
1.10	1.47	1.96	2.61	3.48	4.64	6.19	8.25
1.13	1.50	2.00	2.67	3.57	4.75	6.34	8.45
1.15	1.54	2.05	2.74	3.65	4.87	6.49	8.66
1.18	1.58	2.10	2.80	3.74	4.99	6.65	8.87
1.21	1.62	2.15	2.87	3.83	5.11	6.81	9.09
1.24	1.65	2.21	2.94	3.92	5.23	6.98	9.31
1.27	1.69	2.26	3.01	4.02	5.36	7.15	9.53
1.30	1.74	2.32	3.09	4.12	5.49	7.32	9.76

● E-96系列0603型号《乘数代码对照表》及《电阻值代码对照表》

E-96 series(0603)《multiplied Cross-reference List》and《Resistance Cross-reference List》

表三 Table Three:

乘数multiplied	$\times 10^0$	$\times 10^1$	$\times 10^2$	$\times 10^3$	$\times 10^4$	$\times 10^5$	$\times 10^6$	$\times 10^7$	$\times 10^{-1}$	$\times 10^{-2}$	$\times 10^{-3}$
代码 code	A	B	C	D	E	F	G	H	X	Y	Z

表四 Table Four:

代号 Code	E-96系列电阻 E-96 resistance	代号 Code	E-96系列电阻 E-96 resistance	代号 Code	E-96系列电阻 E-96 resistance	代号 Code	E-96系列电阻 E-96 resistance
01	100	25	178	49	316	73	562
02	102	26	182	50	324	74	576
03	105	27	187	51	332	75	590
04	107	28	191	52	340	76	604
05	110	29	196	53	348	77	619
06	113	30	200	54	357	78	634
07	115	31	205	55	365	79	649
08	118	32	210	56	374	80	665
09	121	33	215	57	383	81	681
10	124	34	221	58	392	82	698
11	127	35	226	59	402	83	715
12	130	36	232	60	412	84	732
13	133	37	237	61	422	85	750
14	137	38	243	62	432	86	768
15	140	39	249	63	442	87	787
16	143	40	255	64	453	88	806
17	147	41	261	65	464	89	825
18	150	42	267	66	475	90	845
19	154	43	274	67	487	91	866
20	158	44	280	68	499	92	887
21	162	45	287	69	511	93	909
22	165	46	294	70	523	94	931
23	169	47	301	71	536	95	953
24	174	48	309	72	549	96	976

◆ 厚膜电阻阻值代码及标记规则
Description for Resistance Value Code and Marking of Thick Film Chip Resistor
● 阻值代码 Resistance Value Code



所有厚膜电阻的阻值代码与其标记是相对应的。

All the resistance value code of thick film chip resistor is corresponding with the marking .

● 标记 Marking

* E-24系列(≥ 0603 、 $\geq \pm 5\%$): 采用三位数字表示, 前二位表示电阻值有效数字, 第三位表示乘以10的次方数。

E-24 series: Express resistance value on the glass side with three digits, the first two digits should be significant and the third one denote number of zeros.

例 For example:  \longrightarrow 30K Ω  \longrightarrow 33 Ω

* E-24系列 (0603、 $\leq \pm 1\%$): 在三位数字标记下方增加下横线识别。

E-24 series(0603、 $\leq \pm 1\%$): Three digits with one short bar under marking letter.

例 For example: 

* E-96系列和E24系列 (≥ 0805 、 $\leq \pm 1\%$):

▲ 采用四位数字表示, 前三位表示电阻值有效数字, 第四位表示乘以10的次方数。

E-96 series & E-24 series (≥ 0805 、 $\leq \pm 1\%$):

Express the resistance value with four digits, the first three digits are significant figures and the fourth denotes the number of zeros.

例 For example:  \longrightarrow 100K Ω

* E-96系列 (0603、 $\leq \pm 1\%$):

▲ 采用三位代码表示, 前二位表示E-96系列阻值代码, 后一位字母表示乘数代码(见表三和表四)。

Express the resistance value with three code, the first two digit code denote the resistance of E-96 series, and the third code of letter denote the multiplier (see the table three and four).

例 For example:  \longrightarrow 2M Ω

* 小数点以“R”表示 The decimal point should be expressed by “R” .

例 For example:  \longrightarrow 5.6 Ω  \longrightarrow 22 Ω

* 跨接电阻以“0”表示 The jumper should be expressed by “0”

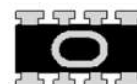
例 For example:  \longrightarrow 0 Ω  \longrightarrow 0 Ω

* ≤ 0402 产品不作标记 For the chip resistor(≤ 0402), there is no mark on the glass side.

例 For example: 

* 非IEC标准系列的电阻值标记表示方法: 一般以最接近IEC E24系列标称阻值的标记表示方法。

For the resistance which don't belong to IEC serial, use the resistance of IEC serial which is most close to the required resistance of non-IEC serial for replacement.

* 客户对标记有特殊要求时, 则按照协商的结果印刷标记。

To get agreement by both party if there special requirement for the marking.

◆ 薄膜电阻阻值代码及标记规则
Description for Resistance Value Code and Marking of Thin Film Chip Resistor
● 阻值代码 Resistance Value Code

所有薄膜电阻全尺寸统一采用四位数阻值代码表示。

All resistance value code of thin film chip resistor used four digits.

例 Example

TD03G4701BT

四位数代号表示，如：4701=4.7KΩ；1R50=1.5Ω

To use four digits code represent resistance value，

例 Example 4701=4.7KΩ；1R50=1.5Ω

● 标记 Marking

* 当阻值同时存在于E24和E96系列时，优先采用E96系列。

When resistance value belongs to E24 as well as E96 series, we suggest preferentially use E96 series.

例 Example 10K=1002, ≠103

* ≥0805 产品标记 For the chip resistor (≥0805):

▲ 印刷四位数字代码；

Express the resistance value with four digits code;

例 Example



* 0603标记 Marking for 0603 Size Resistor

▲ 0603-E96系列：印刷三位字母代码；

For resistance value belongs to E96 series, express the resistance value with three digits code.

例 Example



▲ 0603-E24系列：印刷三位数字代码；

For resistance value belongs to E24 series, express the resistance value with three digits code.

例 Example



* ▲ 小数点以"R"表示 The decimal point should be expressed by"R".

例 Example



* ≤0402产品：不作标记 For the chip resistor (≤0402), there is no mark on the glass side.

例 Example



◆ 电流检测电阻阻值代码及标记规则
Description for Resistance Value Code and Marking of Current Sensing Thick Film Chip Resistor
● 阻值代码 Resistance Value Code

所有电流检测电阻全尺寸 统一采用四位数阻值代码表示。

All resistance value code of current sensing thick film chip resistor used four digits.

例 Example

RBF03MR010FT

四位数代号表示，如：R010=10mΩ；30M1=30.1mΩ

To use four digits code represent resistance value，

例 Example R010=10mΩ；30M1=30.1mΩ

● 标记 Marking

* E-24和E-96系列(≥0805、≤±5%)：采用四位标记代码。

For the chip resistor (≥0805、≤±5%)，when resistance value belongs to E24 and E96 series，we suggest preferentially use four digits.

标记代码 Mark Code	阻值范围 Resistance Value	示例 Sample
R00X	1mΩ ≤ R ≤ 9mΩ	R005=5mΩ
R0XX	10mΩ ≤ R ≤ 99mΩ	R033=33mΩ
RXXX	100mΩ ≤ R ≤ 999mΩ	R100=100mΩ
XMXX	1mΩ < R < 10mΩ (包含小数点后两位有效数字) (Contains two significant digits after the decimal point.)	5M10=5.1mΩ
XXMX	10mΩ < R < 100mΩ (包含小数点后一位有效数字) (Contains one significant digit after the decimal point.)	30M1=30.1mΩ

* E-24和E-96系列(0603、≤±5%)：采用三位标记代码。

For the chip resistor (0603、≤±5%)，when resistance value belongs to E24 and E96 series，we suggest preferentially use three digits.

标记代码 Mark Code	阻值范围 Resistance Value Range	示例 Sample
V0X	1mΩ ≤ R ≤ 9mΩ	V05=5mΩ
VXX	10mΩ ≤ R ≤ 99mΩ	V33=33mΩ
RXX	100mΩ ≤ R ≤ 999mΩ	R10=100mΩ
XXM	1mΩ < R < 10mΩ (包含小数点后一位有效数字) (Contains one significant digit after the decimal point.)	5M1=5.1mΩ

* ≤0402产品不印刷标记。

For the chip resistor (≤0402)，there is no mark on the glass side.

* 非IEC标准系列的电阻值标记表示方法：一般以最接近IEC E24系列标称阻值的标记表示方法。

For the resistance which don't belong to IEC serial，use the resistance of IEC serial which is most close to the required resistance of non-IEC serial for replacement.

* 客户对标记有特殊要求时，则按照协商的结果印刷标记。

To get agreement by both party if there special requirement for the marking.

◆片式电阻器使用说明 Chip Resistor Instructions for Use

● 本产品以下特殊环境下应用，性能可能会受到影响：

- 1、在各种类型的液体，包括水、油、化学品、有机溶剂的使用。
- 2、在户外直接暴露在阳光的地方，或在灰尘多的地方使用。
- 3、在产品暴露的地方，有海风或腐蚀性气体，包括氯气、硫化氢、氨气、二氧化硫、二氧化氮等。
- 4、在产品暴露于静电或电磁波的地方使用。
- 5、在产生热量的部件、塑料线，或其他易燃物品附近使用。
- 6、在用树脂或其他涂层材料密封产品的情况下使用。
- 7、焊接后使用不洁焊料或使用水或水溶性清洗剂清洗产品。
- 8、片状电阻器的基材是氧化铝。由于和安装基板的热膨胀系数不同，在反复施加提供热循环等热应力时，接合部的焊锡（焊缝部）有时会发生裂纹。如果环境温度反复发生很大的变动，并且载荷反复进行ON/OFF，则需要注意龟裂的发生。因热应力而发生的龟裂，取决于所安装的焊盘的大小、焊锡量、安装基板的散热性等，因此在环境温度有很大的变化或载荷ON/OFF的条件下使用时，请充分注意以进行设计。

◆ Application of the products in a special environment can deteriorate product performance:

- 1、Use in various types of liquid, including water, oils, chemicals, and organic solvents.
- 2、Use outdoors where the products are exposed to direct sunlight, or in dusty places.
- 3、Use in places where the products are exposed to sea winds or corrosive gases, including Cl_2 , H_2S , NH_3 , SO_2 , and No_2 etc.
- 4、Use in places where the products are exposed to static electricity or electromagnetic waves.
- 5、Use in proximity to heat-producing components, plastic cords, or other flammable items.
- 6、Use involving sealing or coating the products with resin or other coating materials.
- 7、Use involving unclean solder or use of water or water-soluble cleaning agents for cleaning after soldering.
- 8、The substrate of chip resistors is alumina. Cracks may occur at the connection of solder (solder fillet portion) due to the difference of the coefficient of thermal expansion from a mounting board when heat stress like heat cycle, etc. are repeatedly given to them. Care should be taken to the occurrence of the cracks when the change in ambient temperature or ON/OFF of load is repeated. The occurrence of the crack by heat stress may be influenced by the size of a pad, solder volume, heat radiation of mounting board etc., so please pay careful attention to designing when a big change in ambient temperature and conditions for use like ON/OFF of load can be assumed.

◆ 产品使用注意事项

- 1、避免采用超过正常额定功率的功率，超过额定功率的稳态负载条件下可能会对产品性能和可靠性产生负面影响。
- 2、用镊子拿起产品时要小心，有可能会将保护或电阻体夹碎。
- 3、手动安装产品时，烙铁头勿触碰产品。
- 4、贮存条件：温度 $5^{\circ}C \sim 30^{\circ}C$ ，相对湿度30%~70%。
建议在符合上述储存条件下六个月内使用。
- 5、用于车载设备、医疗设备、航空设备以及其它涉及人身安全、或可能引起重大损失的设备上时，请务必事先与我公司联系。这些产品在这类用途中出现故障或失灵可能导致人身事故或严重损坏。

◆ Precautions on use of products

- 1、Avoid applying power exceeding normal rated power, exceeding the power rating under steady-state loading condition may negatively affect product performance and reliability.
- 2、Be careful when pick up the products with tweezers. There may be a care that the overcoat and / or the body can be chipped.
- 3、Soldering tip shall not touch the product when install product manually.
- 4、Storage conditions: T: $5^{\circ}C \sim 30^{\circ}C$, RH: 30%~70%.
The products are suggested to be used within six months when received, and the storage condition mentioned above should be followed.
- 5、Contact our sales representatives before you use our products for applications including automotive, medical equipment and aerospace equipment. Malfunction or failure of the products in such applications may cause loss of human life or serious damage.

◆ 焊接 Soldering

- 推荐的回流焊曲线 Recommended reflow profile
- 推荐的波峰焊曲线 Recommended wave solder profile

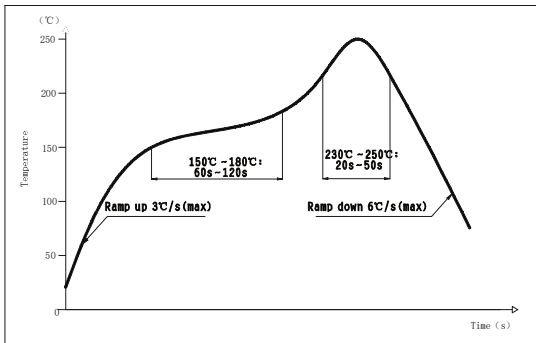

- 推荐的焊膏类型 Recommended solder alloy: 96.5Sn/3.0Ag/0.5Cu