

FEATURES

* International standard package

APPLICATIONS

* DC motor control

* Softstart AC motor controller

* Light, heat and temperature control

ADVANTAGES

* Space and weight savings

* Simple mounting with two screws

* Improved temperature and power cycling

* Reduced protection circuits

Symbol	Test Conditions	Maximum Ratings	Unit
I_{TRMS} , I_{FRMS} I_{TAVM} , I_{FAVM}	$T_{VJ}=T_{VJM}$ $T_C=85^{\circ}C$; 180° sine	260 160	A
I_{TSM} , I_{FSM}	$T_{VJ}=45^{\circ}C$ t=10ms (50Hz), sine $V_R=0$ t=8.3ms (60Hz), sine	6000 6400	A
	$T_{VJ}=T_{VJM}$ t=10ms(50Hz), sine $V_R=0$ t=8.3ms(60Hz), sine	5250 5600	
i_{zdt}	$T_{VJ}=45^{\circ}C$ t=10ms (50Hz), sine $V_R=0$ t=8.3ms (60Hz), sine	180000 170000	A2s
	$T_{VJ}=T_{VJM}$ t=10ms(50Hz), sine $V_R=0$ t=8.3ms(60Hz), sine	17000 128000	
$(di/dt)_{cr}$	$T_{VJ}=T_{VJM}$ repetitive, $I_T=45A$ f=50Hz, $t_p=200\mu s$ $V_D=2/3V_{DRM}$ $I_G=0.45A$ non repetitive, $I_T=I_{TAVM}$ $di_G/dt=0.45A/\mu s$	150 500	A/ μs
	$T_{VJ}=T_{VJM}$; $V_{DR}=2/3V_{DRM}$ $R_{GK} =$; method 1 (linear voltage rise)	1000	
P_{GM}	$T_{VJ}=T_{VJM}$ $t_p=30\mu s$ $I_T=I_{TAVM}$ $t_p=300\mu s$	120 60	W
P_{GAV}		8	W
V_{RGM}		10	V
T_{VJ} T_{VJM} T_{stg}		-40...+125 125 -40...+125	$^{\circ}C$
V_{ISOL}	50/60Hz, RMS t=1min $I_{ISOL}<1mA$ t=1s	3000 3600	V~
M_d	Mounting torque (M5) Terminal connection torque (M5)	2.5-4.0/22-35 2.5-4.0/22-35	Nm/lb.in.
Weight	Typical including screws	280	g

Symbol	Test Conditions	Maximum Ratings	Unit
IRRM, IDRM	TVJ=TVJM; VR=VRRM; VD=VDRM	10	mA
VT, VF	IT, IF=162A; TVJ=25oC	1.38	V
VTO	For power-loss calculations only (TVJ=125oC)	0.88	V
rT		1.15	mΩ
VGT	VD=6V; TVJ=25oC	2.5	V
	TVJ=-40oC	2.6	
IGT	VD=6V; TVJ=25oC	150	mA
	TVJ=-40oC	200	
VGD	TVJ=TVJM; VD=2/3VDRM	0.2	V
IGD		10	mA
IL	TVJ=25oC; tp=10us; VD=6V	300	mA
	IL IG=0.45A; diG/dt=0.45A/us		
IH	TVJ=25oC; VD=6V; RGK=	200	mA
tgD	TVJ=25oC; VD=1/2VDRM IG=0.45A; diG/dt=0.45A/us	2	us
tq	TVJ=TVJM; IT=20A; tp=200us; -di/dt=10A/us VR=100V; dv/dt=20V/us; VD=2/3VDRM	150	us
QS	TVJ=TVJM; IT, IF=25A; -di/dt=0.64A/us	550	uC
IRM		235	A
RthJC	per thyristor/diode; DC current	0.155	K/W
	per module	0.0755	
RthJK	per thyristor/diode; DC current	0.255	K/W
	per module	0.1125	
dS	Creeping distance on surface	12.7	mm
dA	Strike distance through air	9.6	mm
a	Maximum allowable acceleration	50	m/s ²

Outline Table

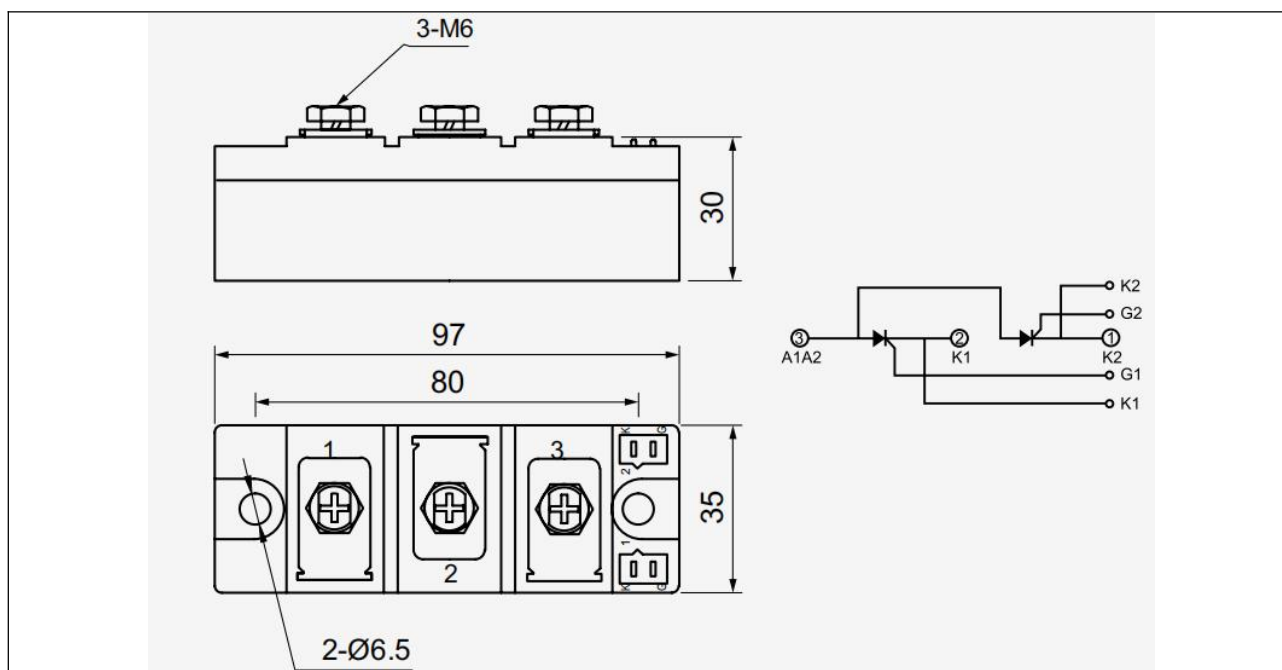

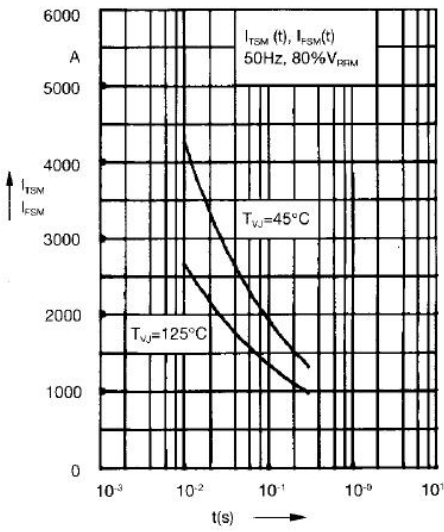

Fig. 3 Surge overload current
 I_{TSM}, I_{FSM} : Crest value, t : duration

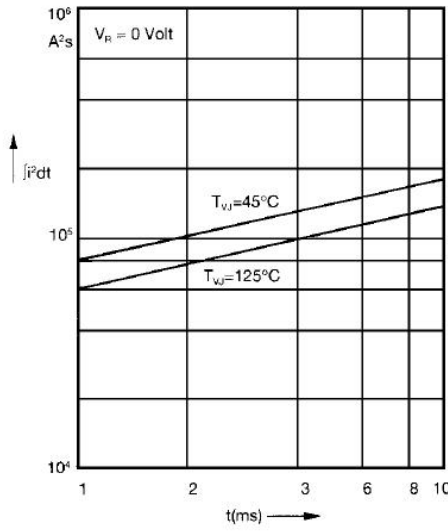

Fig. 4 $\int i^2 dt$ versus time (1-10 ms)

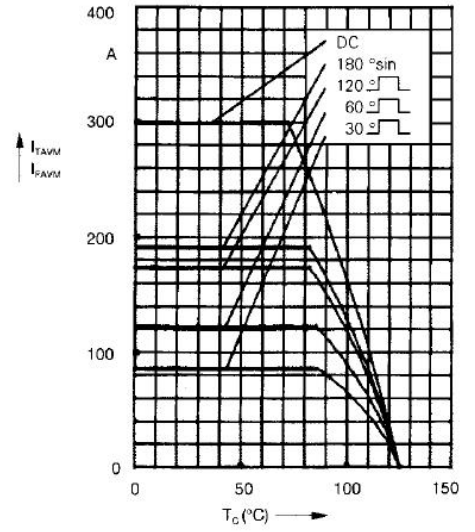

Fig. 4a Maximum forward current at case temperature

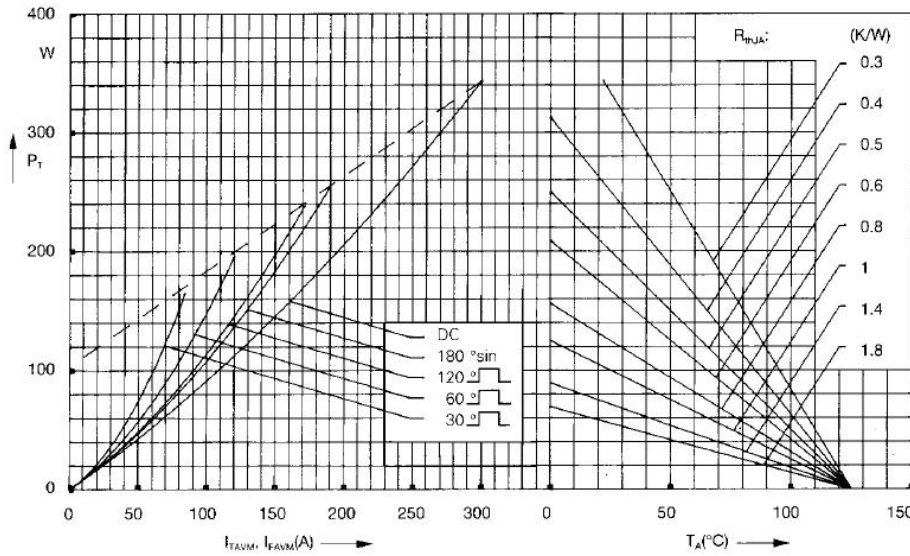

Fig. 5 Power dissipation versus on-state current and ambient temperature (per thyristor or diode)

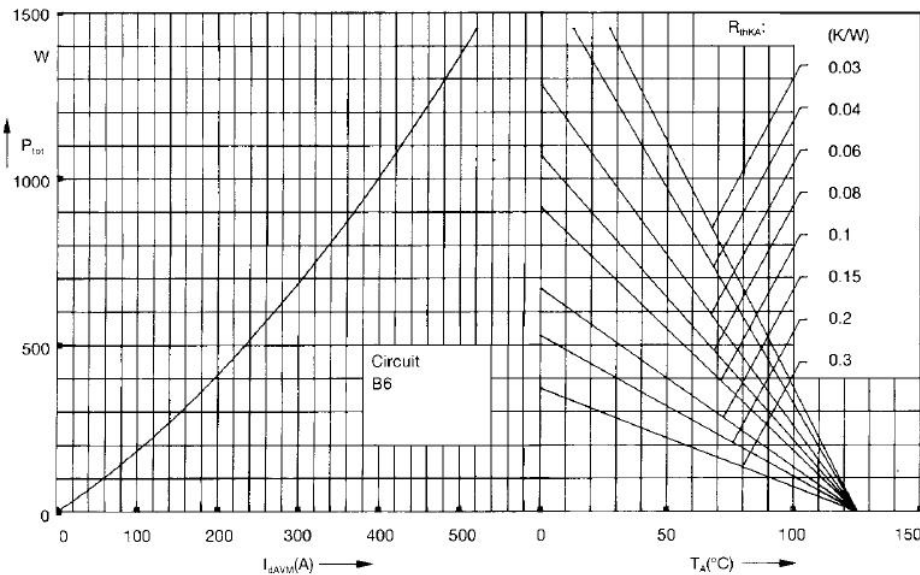

Fig. 6 Three phase rectifier bridge: Power dissipation versus direct output current and ambient temperature

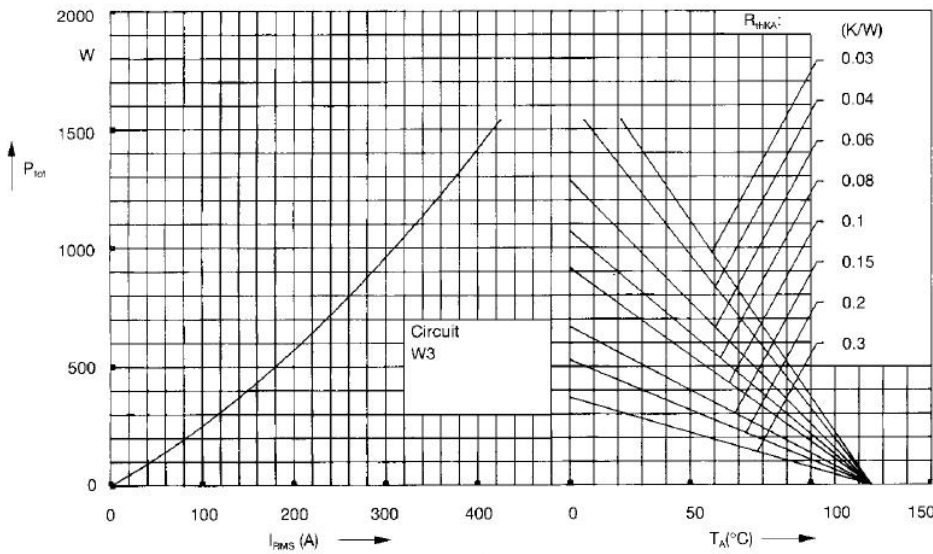

Fig. 7 Three phase AC-controller: Power dissipation versus RMS output current and ambient temperature

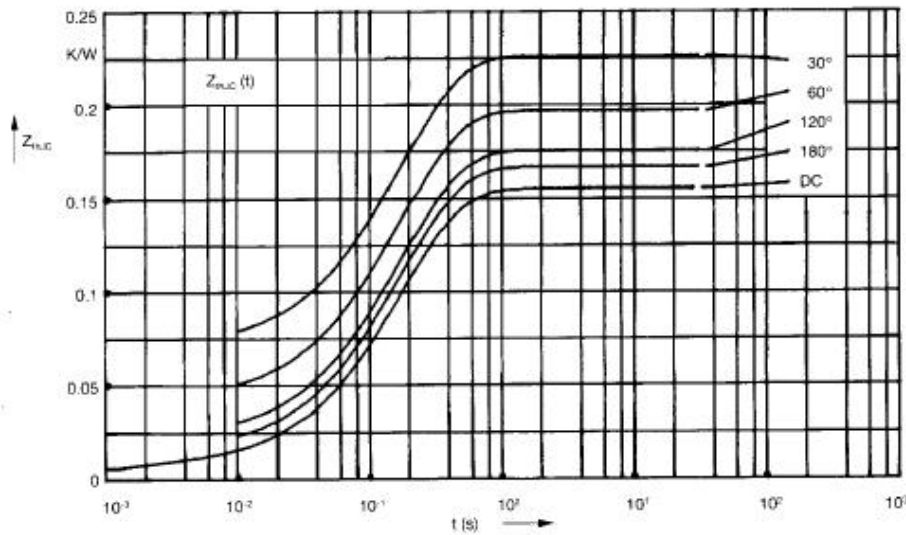

Fig. 8 Transient thermal impedance junction to case (per thyristor or diode)

R_{thjc} for various conduction angles d:

d	R_{thjc} (K/W)
DC	0.155
180°	0.167
120°	0.176
60°	0.197
30°	0.227

Constants for Z_{thjc} calculation:

i	R_{thi} (K/W)	t_i (s)
1	0.0072	0.001
2	0.0188	0.08
3	0.129	0.2

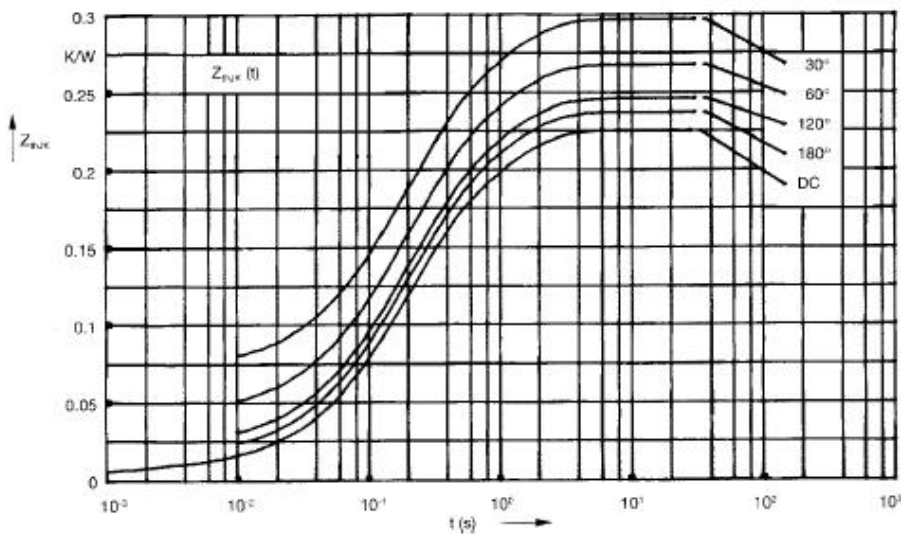

Fig. 9 Transient thermal impedance junction to heatsink (per thyristor or diode)

R_{thjk} for various conduction angles d:

d	R_{thjk} (K/W)
DC	0.225
180°	0.237
120°	0.246
60°	0.267
30°	0.297

Constants for Z_{thjk} calculation:

i	R_{thi} (K/W)	t_i (s)
1	0.0072	0.001
2	0.0188	0.08
3	0.129	0.2
4	0.07	1.0