

## Data sheet

Commercial Art.No.: 92.932.3853.0

Connector GST18I3S S1 ZR1 BR05

GST18i3 connector, 3 pole, male with screw connection, coding switching function  
250 V, 20 A, coding color brown, strain relief color black



Commercial Art.No.	92.932.3853.0
EAN	4015573987005
Order Unit	1

Certificates / Approvals



## Technical data

### General

Rated current	20 A
Rated voltage	250 V
Rated impulse voltage	4 kV
strain relief	yes
Pollution degree	2
Mechanical coding	Code 4
Lockable	self-locking (unlocking by tool)
Color of coding/ contact carrier	brown
Marking of poles	1, 2, 3
Color of housing inclusive strain relief	black

### Connection Data

Cable diameter max.	10.5 mm
Cable diameter min.	6.5 mm
Connection cross section solid mm <sup>2</sup> max.	2.5 mm <sup>2</sup>
Connection cross section solid mm <sup>2</sup> min.	0.5 mm <sup>2</sup>
Connection cross section fine stranded mm <sup>2</sup> max.	2.5 mm <sup>2</sup>
Connection cross section fine stranded mm <sup>2</sup> min.	0.5 mm <sup>2</sup>
Terminations per pole	1
sheath strip length	38.5 mm
Wire strip length	7 mm

### Model

Model	male
Connection type	screw connection

Degree of protection (IP)	IP20
---------------------------	------

#### Material

Housing material	Polyamide
halogen free	yes
Contact material	CuZn
Fire load	0.093 kWh
Insulation components continuous temperature	100 °C
Surface finish	Tin-plated

#### Dimensions

Length	69.4 mm
Width	28.2 mm
Height	12.6 mm

#### Classification

ECLASS 11	
ECLASS 8.1	27440605
ETIM 7.0	EC002560
ETIM 6.0	EC002560
ETIM 5.0	EC002560
ETIM 4.0	EC002560

#### Product compliance

ROHS conformity status	Compliant/Exempted
ROHS exceptions	III-6(c)
REACH-SVHC conformity status	Duty-To-Declare
REACH-SVHC substances	Lead
REACH-SVHC CAS numbers	7439-92-1

#### Accessories

Commercial Art.No.:	Article-type description:	Description:
05.587.3156.0	Lock (G)ST18 WS	Locking device for cable to cable connection GST18i3-5, white
06.561.7853.0	mounting frame GST18i3 SW	Mounting frame to snap in GST18i3 connectors into a housing or furniture. Wall thickness: 1,5-2,5 mm. Holds GST18i3 connectors with screw or spring connection and pre- assembled cables.
05.561.3653.0	cover cap GST18i3VS B WS	Cover piece for female GST18i3, white
05.561.3653.1	cover cap GST18i3VS B SW	Cover piece for female GST18i3, black
05.564.5353.0	cover cap GST18i3/4/5 SW	Cover piece 12 pole black for female parts GST18i3-6
05.564.5353.2	cover cap GST18i3/4/5 WS	Cover piece 12 pole white for female parts GST18i3-6
05.594.4250.0	cover cap ST18/3B + GST18i3 ST WS	
05.594.4253.0	cover cap ST18/3B + GST18i3 ST WS	
05.587.3156.1	Lock (G)ST18 SW	Locking device for cable to cable connection GST18i3-5, black

#### Fits with

Commercial Art.No.:	Article-type description:	Description:

92.931.3853.0	Connector GST18i3S B1 ZR1 BR05	GST18i3 connector, 3 pole, female with screw connection, coding switching function 250 V, 20 A, coding color brown, strain relief color black
92.031.3258.0	Device connector GST18i3S B1 WS	GST18i3 built-in component, 3 pole, female with screw connection, coding mains 250 V, 20 A, coding color white
92.031.0058.0	Device connector GST18i3L B1V WS	GST18i3 PCB mount with additional mounting option, 3 pole, female (vertical), coding mains 250 V, 20 A, coding color white
92.031.3458.0	Device connector GST18i3S B1 GR01	GST18i3 built-in component, 3 pole, female with screw connection, coding UPS 250 V, 20 A, coding color pebble grey
92.031.0158.0	Device connector GST18i3L B1V GR01	GST18i3 PCB mount with additional mounting option, 3 pole, female (vertical), coding UPS 250 V, 20 A, coding color pebble grey
92.031.3658.0	Device connector GST18i3S B1 RT03	GST18i3 built-in component, 3 pole, female with screw connection, coding mains 250 V, 20 A, coding color salmon pink
92.031.3858.0	Device connector GST18i3S B1 BR05	GST18i3 built-in component, 3 pole, female with screw connection, coding switching function 250 V, 20 A, coding color brown
92.031.0658.0	Device connector GST18i3L B1V BR05	GST18i3 PCB mount with additional mounting option, 3 pole, female (vertical), coding switching function 250 V, 20 A, coding color brown
92.297.1003.0	Cable assembly GST18i3KSB- 15 10TR01	GST18i3 extension cable female - free end, length 1.0 m, 3 pole, coding UPS 250 V, 16 A, coding color tomato red, strain relief color black, cable color black, cross section 1.5 mm <sup>2</sup> , cable type H05VV-F, fire class: Eca
92.232.1004.4	Cable assembly GST18i3KS-S 15 10BR05	GST18i3 extension cable male - free end, length 1.0 m, 3 pole, coding switching function 250 V, 16 A, coding color brown, strain relief color black, cable color black, cross section 1.5 mm <sup>2</sup> , cable type H05VV-F, fire class: Eca
92.031.0758.0	Device connector GST18i3L B1V RT03	GST18i3 PCB mount with additional mounting option, 3 pole, female (vertical), coding mains 250 V, 20 A, coding color salmon pink
92.031.0858.0	Device connector GST18i3L B1V H RT03	Device connector, PCB mount, GST18i3, 3 pole, vertical, with fixing hooks, female, 250 V, 20 A, colour of coding: salmon red
92.232.1003.4	Cable assembly GST18i3KSB- 15 10BR05	GST18i3 extension cable female - free end, length 1.0 m, 3 pole, coding switching function 250 V, 16 A, coding color brown, strain relief color black, cable color black, cross section 1.5 mm <sup>2</sup> , cable type H05VV-F, fire class: Eca
92.232.1000.4	Cable assembly GST18i3KSBS 15 10BR05	GST18i3 connection cable female - male, length 1.0 m, 3 pole, coding switching function 250 V, 16 A, coding color brown, strain relief color black, cable color black, cross section 1.5 mm <sup>2</sup> , cable type H05VV-F, fire class: Eca
92.031.0358.0	Device connector GST18i3L B1V GN07	gegis® device connector, PCB mount, GST18i3, 3 pole, vertical, female, 250 V, 20 A, colour of coding: may green
92.031.3558.0	Device connector GST18i3S B1 GN07	GST18i3 built-in component, 3 pole, female with screw connection, coding according to customer requirement with PE, 20 A, coding color may green
92.031.0558.0	Device connector GST18i3L B1V TB06	GST18i3 PCB mount with additional mounting option, 3 pole, female (vertical), coding mains 250 V, 20 A, coding color turquoise blue
92.031.3958.0	Device connector GST18i3S B1 TB06	GST18i3 built-in component, 3 pole, female with screw connection, coding according to customer requirement without PE, 20 A, coding color turquoise blue
92.031.3758.0	Device connector GST18i3S B1 PB04	GST18i3 built-in component, 3 pole, female with screw connection, coding not SELV, 20 A, coding color pastel blue
92.031.0458.0	Device connector GST18i3L B1V PB04	GST18i3 PCB mount with additional mounting option, 3 pole, female (vertical), coding not SELV, 20 A, coding color pastel blue

Auslieferungszustand: unmontiert  
delivery condition: unmounted

These dimensions will be especially checked at delivery  
 Only inspection dimensions  
 With /E marked dimensions are only valid for internal use

Diese Maße werden bei Abnahme besonders geprüft  
 Ausschließlich Prüfmaße  
 Mit /E gekennzeichnete Maße sind nur für interne Zwecke gültig

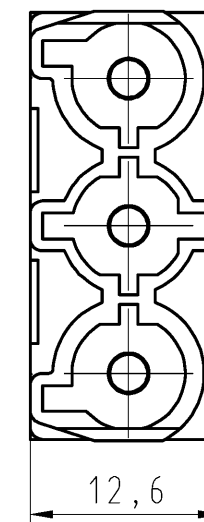
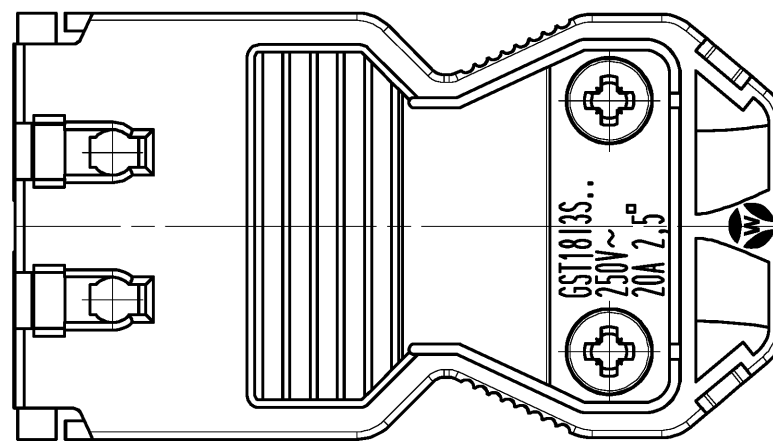
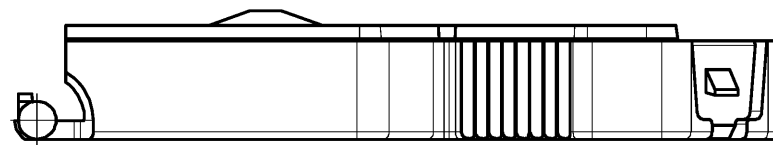
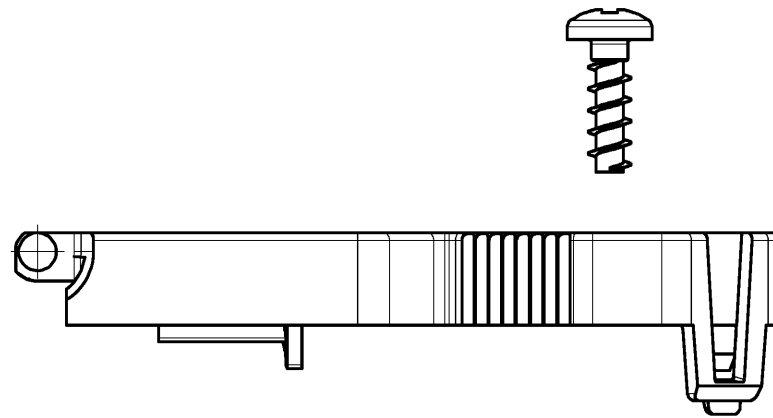
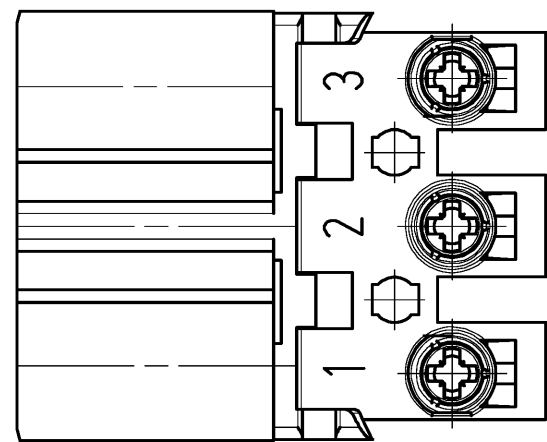
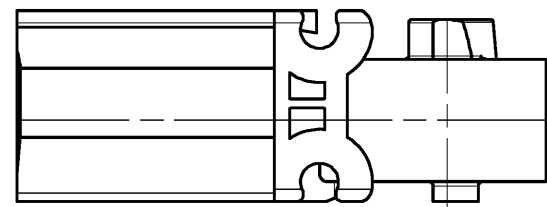

Anwendung: Schaltanwendung  
Application: switching application

Ansicht im montierten Zustand  
drawn in assembled condition

M/scale 1:1

Type:  
 GST1813S S1 ZR1 BR05

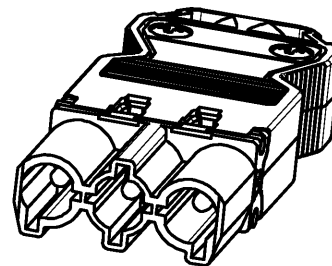
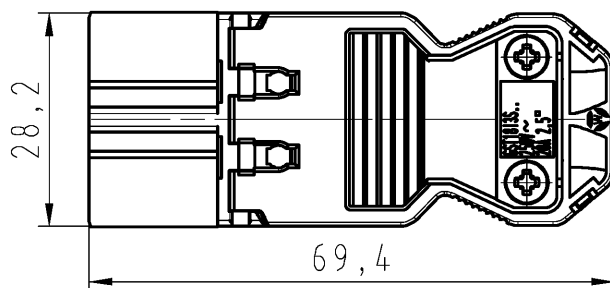

Tolerierung Size ISO 14405 (E) / Tolerance system Size ISO 14405 (E). (This ISO-standard describes the envelope principle. According to the envelope principle the deviations of form and parallelism are limited by the size tolerances).				ja/yes <input checked="" type="checkbox"/> Stoffverbots- und Deklarationsliste nach UU-TQM-05/03 ist einzuhalten. Conformity with Wieland document UU-TQM-05/03 (list of prohibited / declarable hazardous substances) to be declared!			
Freitoleranz nach General tolerance		CAD - Zeichnung, keine manuellen Änderungen CAD - drawing, no manual modifications allowed		1. Verwendung: - First Use:		Blatt: 1 von 1 Sheet: of	
/		Werkstoff/Material Farbe: braun colour: brown		2007 Tag/Date Name gezeichnet/drawn 24.09. Schaber		Zeichnung Nr./Drawing No. 92.932.3853.0 01K	
/ Maßstab/Scale 2:1		/		/ Normgepr. / Stand. check		Maße in mm/Dimensions are in mm	
/ Vol.		mm <sup>3</sup> Of l./Surf. mm <sup>2</sup>		Ersatz für/Replacement for: -		Index	
/		/		/		/	
/		/		/		/	
Index		Datum / Blatt Date / Sheet		Type		Benennung/Title	
Änderung/Revision		wieland Elektrische Verbindungen		MALE CONNECTOR WITH STRAIN RELIEF STECKERT MIT ZUGENTLASTUNG mit Schraubanschluss / with screw connection 250V AC 20A 2,5qmm			

Weitergabe sowie Vervielfältigung dieses Dokuments, Verwertung und Mitteilung seines Inhalts sind verboten, soweit nicht ausdrücklich gestattet.  
 The reproduction, distribution and utilization of this document as well as the communication of its contents to others without express authorization is prohibited.