

Features:

- Isolated mounting base 3000V~
- Pressure contact technology with increased power cycling capability
- Space and weight savings

Typical Applications

- AC/DC Motor drives
- Various rectifiers
- DC supply for PWM inverter

V_{RSM}	V_{RRM}	Type & Outline
2100 V	2000 V	MD500-20-417F2
2300 V	2200 V	MD500-22-417F2
2600 V	2500 V	MD500-25-417F2

SYMBOL	CHARACTERISTIC	TEST CONDITIONS	$T_j(^{\circ}C)$	VALUE			UNIT
				Min	Type	Max	
$I_{F(AV)}$	Mean forward current	180° half sine wave 50Hz Single side cooled, $T_c=100^{\circ}C$	150			500	A
$I_{F(RMS)}$	RMS forward current		150			785	A
I_{RRM}	Repetitive peak current	at V_{RRM}	150			40	mA
I_{FSM}	Surge forward current	10ms half sine wave	150			16.0	KA
I^2t	I^2T for fusing coordination	$V_R=0.6V_{RRM}$				1280	$A^2s \cdot 10^3$
V_{FO}	Threshold voltage		150			0.85	V
r_F	Forward slop resistance					0.38	m Ω
V_{FM}	Peak forward voltage	$I_{FM}=1500A$	25			1.65	V
$R_{th(j-c)}$	Thermal resistance Junction to case	At 180° sine Single side cooled				0.075	$^{\circ}C/W$
$R_{th(c-h)}$	Thermal resistance case to heatsink	At 180° sine Single side cooled				0.04	$^{\circ}C/W$
V_{iso}	Isolation voltage	50Hz, R.M.S, t=1min, $I_{iso}:1mA(max)$		3000			V
F_m	Terminal connection torque(M10)				12		N·m
	Mounting torque(M6)				6		N·m
T_{vj}	junction temperature			-40		150	$^{\circ}C$
T_{stg}	Stored temperature			-40		125	$^{\circ}C$
W_t	Weight				764		g
Outline	417F2						

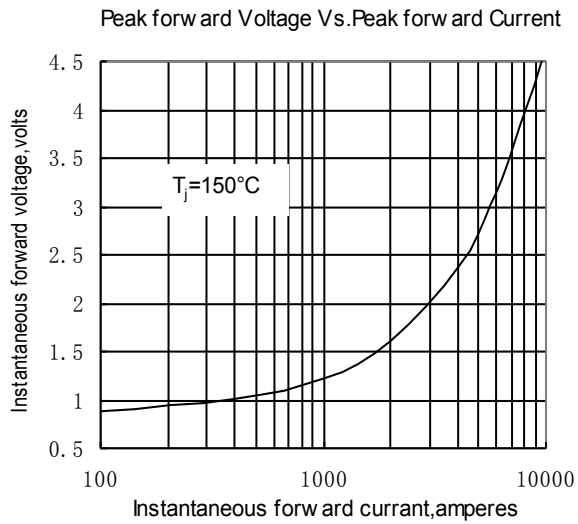

Fig.1

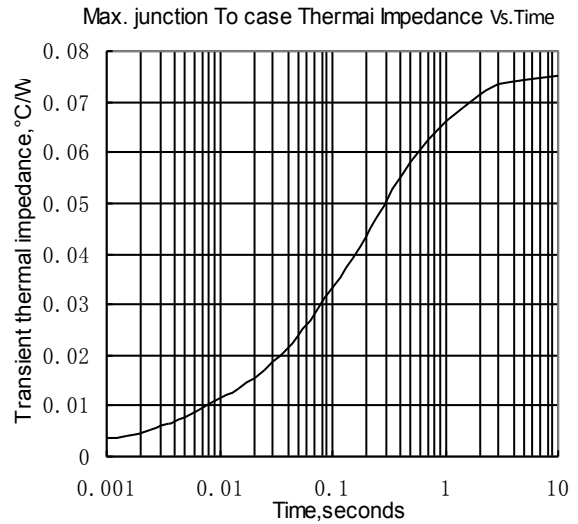

Fig.2

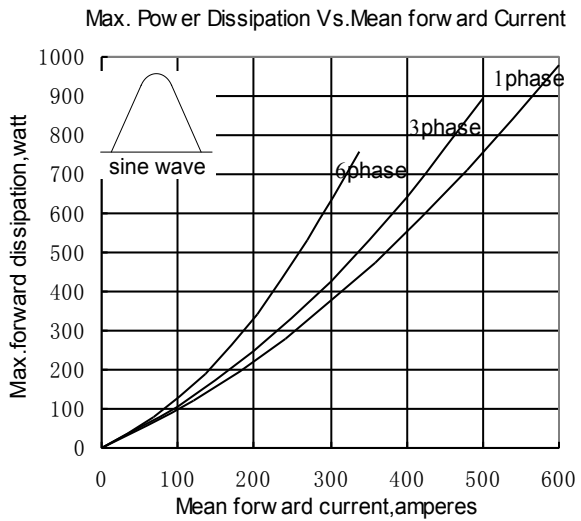

Fig.3

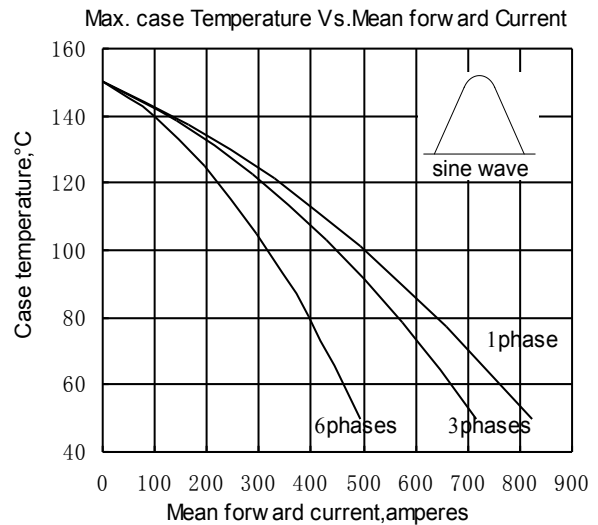

Fig.4

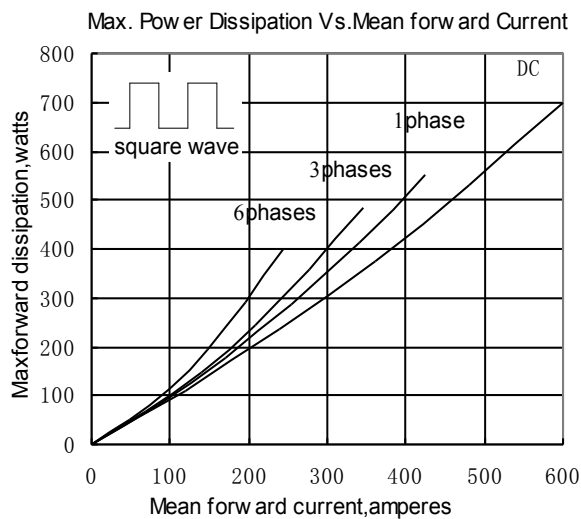

Fig.5

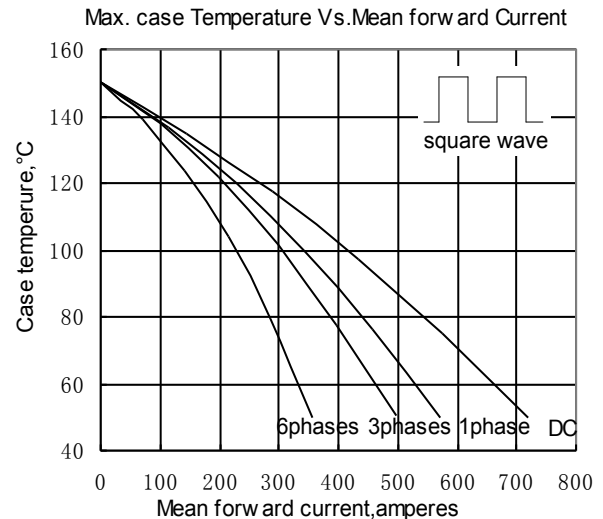

Fig.6

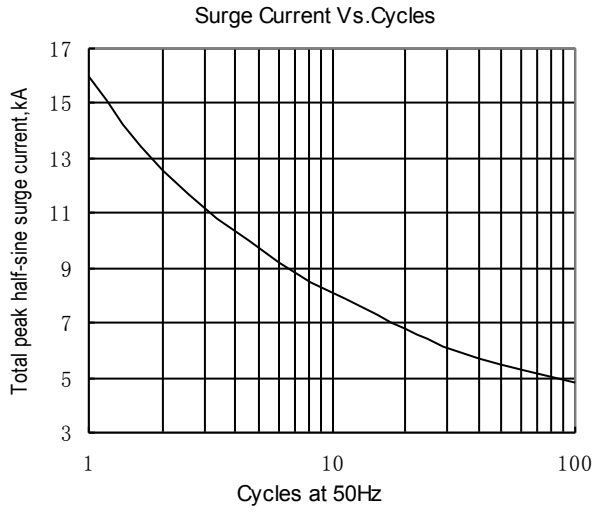

Fig.7

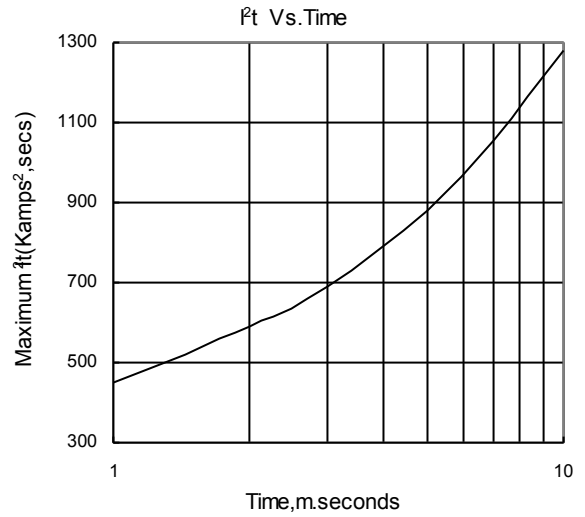
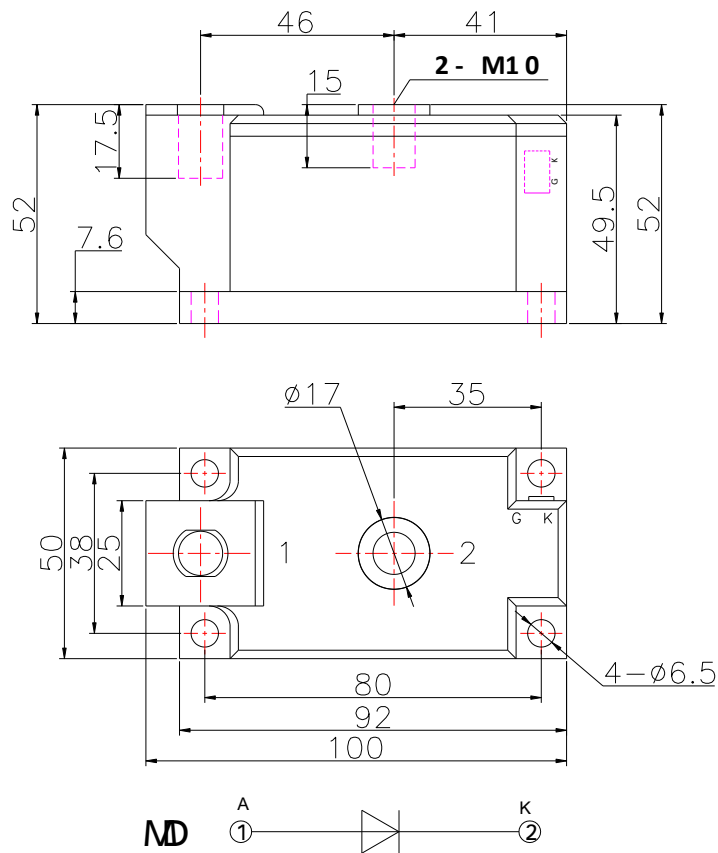

Fig.8

Outline:



417F2