

## TPD1E10B06 Single-Channel ESD Protection Diode in 0402 Package

### 1 Features

- Provides System-Level ESD Protection for Low-Voltage I/O Interface
- IEC 61000-4-2 Level 4 ESD Protection
  - $\pm 30$  kV Contact Discharge
  - $\pm 30$  kV Air-Gap Discharge
- IEC 61000-4-5 Surge: 6 A (8/20  $\mu$ s)
- I/O Capacitance 12 pF (Typical)
- $R_{DYN}$  0.4  $\Omega$  (Typical)
- DC Breakdown Voltage  $\pm 6$  V (Minimum)
- Ultralow Leakage Current 100 nA (Maximum)
- 10-V Clamping Voltage (Max at  $I_{PP} = 1$  A)
- Industrial Temperature Range:  $-40^{\circ}\text{C}$  to  $125^{\circ}\text{C}$
- Space-Saving 0402 Footprint (1 mm  $\times$  0.6 mm  $\times$  0.5 mm)

### 2 Applications

- End Equipment:
  - Tablets
  - Remote Controllers
  - Wearables
  - Set-Top Boxes
  - Electronic Point of Sale (EPOS)
  - ebooks
- Interfaces:
  - Audio Lines
  - Pushbuttons
  - General-Purpose Input/Output (GPIO)

### 3 Description

The TPD1E10B06 device is a single-channel electrostatic discharge (ESD) transient voltage suppression (TVS) diode in a small 0402 package. This TVS protection product offers  $\pm 30$ -kV contact ESD,  $\pm 30$ -kV IEC air-gap protection, and has an ESD clamp circuit with a back-to-back TVS diode for bipolar or bidirectional signal support. The 12-pF line capacitance of this ESD protection diode is suitable for a wide range of applications supporting data rates up to 400 Mbps. The 0402 package is an industry standard and is convenient for component placement in space-saving applications.

Typical applications of this ESD protection product are circuit protection for audio lines (microphone, earphone, and speakerphone), SD interfacing, keypad or other buttons, VBUS pin and ID pin of USB ports, and general-purpose I/O ports. This ESD clamp is good for the protection of the end equipment like ebooks, tablets, remote controllers, wearables, set-top boxes, and electronic point of sale equipment.

#### Device Information<sup>(1)</sup>

PART NUMBER	PACKAGE	BODY SIZE (NOM)
TPD1E10B06	X1SON (2)	0.60 mm $\times$ 1.00 mm

(1) For all available packages, see the orderable addendum at the end of the data sheet.

#### Application Schematic

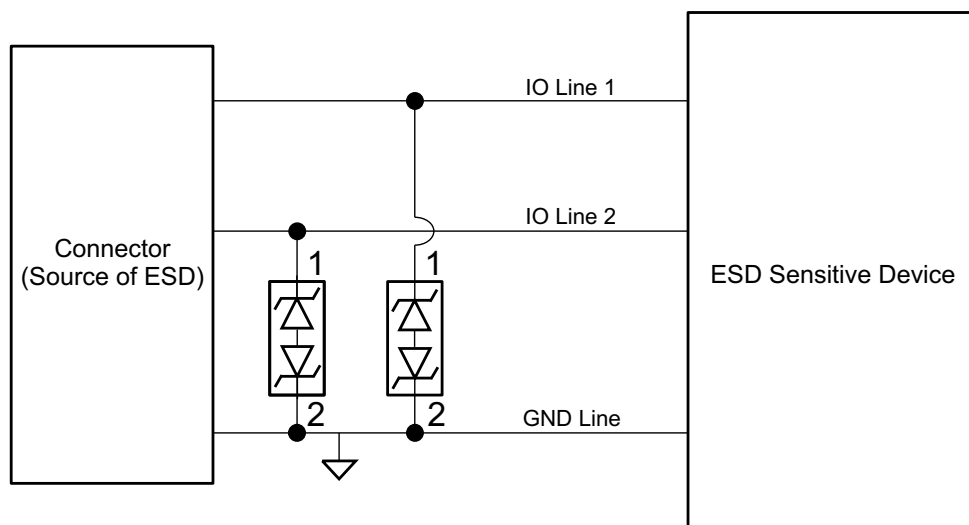

## Table of Contents

<b>1 Features</b> .....	<b>1</b>	7.3 Feature Description .....	<b>7</b>
<b>2 Applications</b> .....	<b>1</b>	7.4 Device Functional Modes .....	<b>7</b>
<b>3 Description</b> .....	<b>1</b>	<b>8 Application and Implementation</b> .....	<b>8</b>
<b>4 Revision History</b> .....	<b>2</b>	8.1 Application Information .....	<b>8</b>
<b>5 Pin Configuration and Functions</b> .....	<b>3</b>	8.2 Typical Application .....	<b>8</b>
<b>6 Specifications</b> .....	<b>3</b>	<b>9 Power Supply Recommendations</b> .....	<b>10</b>
6.1 Absolute Maximum Ratings .....	<b>3</b>	<b>10 Layout</b> .....	<b>10</b>
6.2 ESD Ratings .....	<b>3</b>	10.1 Layout Guidelines .....	<b>10</b>
6.3 Recommended Operating Conditions .....	<b>3</b>	10.2 Layout Example .....	<b>10</b>
6.4 Thermal Information .....	<b>4</b>	<b>11 Device and Documentation Support</b> .....	<b>11</b>
6.5 Electrical Characteristics .....	<b>4</b>	11.1 Community Resources .....	<b>11</b>
6.6 Typical Characteristics .....	<b>5</b>	11.2 Trademarks .....	<b>11</b>
<b>7 Detailed Description</b> .....	<b>7</b>	11.3 Electrostatic Discharge Caution .....	<b>11</b>
7.1 Overview .....	<b>7</b>	11.4 Glossary .....	<b>11</b>
7.2 Functional Block Diagram .....	<b>7</b>	<b>12 Mechanical, Packaging, and Orderable Information</b> .....	<b>11</b>

## 4 Revision History

NOTE: Page numbers for previous revisions may differ from page numbers in the current version.

<b>Changes from Revision C (April 2015) to Revision D</b>	<b>Page</b>
• Added Added test condition frequency to capacitance .....	<b>4</b>
• Added <a href="#">Community Resources</a> .....	<b>11</b>

<b>Changes from Revision B (October 2012) to Revision C</b>	<b>Page</b>
• Added <i>Pin Configuration and Functions</i> section, <i>ESD Ratings</i> table, <i>Feature Description</i> section, <i>Device Functional Modes</i> , <i>Application and Implementation</i> section, <i>Power Supply Recommendations</i> section, <i>Layout</i> section, <i>Device and Documentation Support</i> section, and <i>Mechanical, Packaging, and Orderable Information</i> section .....	<b>1</b>

<b>Changes from Revision A (March 2012) to Revision B</b>	<b>Page</b>
• Added THERMAL INFORMATION table .....	<b>4</b>

<b>Changes from Original (February 2011) to Revision A</b>	<b>Page</b>
• Updated FEATURES .....	<b>1</b>
• Added graphs to TYPICAL CHARACTERISTICS section .....	<b>5</b>
• Added APPLICATION INFORMATION section .....	<b>8</b>

## 5 Pin Configuration and Functions

DPY Package  
2-Pin X1SON  
Top View

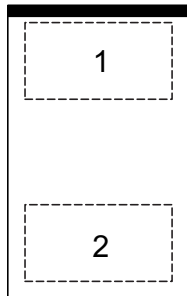

Pin Functions

PIN	I/O	DESCRIPTION
1	I/O	ESD Protected I/O
2		

## 6 Specifications

### 6.1 Absolute Maximum Ratings

	MIN	MAX	UNIT
Operating temperature	–40	125	°C
$I_{PP}$ Peak pulse current (tp = 8/20 $\mu$ s)		6	A
$P_{PP}$ Peak pulse power (tp = 8/20 $\mu$ s)		90	W
$T_{stg}$ Storage temperature	–65	155	°C

### 6.2 ESD Ratings

	VALUE	UNIT
$V_{(ESD)}$ Electrostatic discharge	Human body model (HBM), per ANSI/ESDA/JEDEC JS-001 <sup>(1)</sup>	±2500
	Charged-device model (CDM), per JEDEC specification JESD22-C101 <sup>(2)</sup>	±1000
	IEC 61000-4-2 Contact Discharge	30000
	IEC 61000-4-2 Air-Gap Discharge	30000

(1) JEDEC document JEP155 states that 500-V HBM allows safe manufacturing with a standard ESD control process.

(2) JEDEC document JEP157 states that 250-V CDM allows safe manufacturing with a standard ESD control process.

### 6.3 Recommended Operating Conditions

over operating free-air temperature range (unless otherwise noted)

	MIN	NOM	MAX	UNIT
Operating Free-Air Temperature, $T_A$	–40		125	°C
Operating Voltage	–5.5	Pin 1 to 2 or Pin 2 to 1	5.5	V

## 6.4 Thermal Information

THERMAL METRIC <sup>(1)</sup>		TPD1E10B06	UNIT
		DPY (X1SON)	
		2 PINS	
R <sub>θJA</sub>	Junction-to-ambient thermal resistance	615.5	°C/W
R <sub>θJC(top)</sub>	Junction-to-case (top) thermal resistance	404.8	°C/W
R <sub>θJB</sub>	Junction-to-board thermal resistance	493.3	°C/W
ψ <sub>JT</sub>	Junction-to-top characterization parameter	127.7	°C/W
ψ <sub>JB</sub>	Junction-to-board characterization parameter	493.3	°C/W
R <sub>θJC(bot)</sub>	Junction-to-case (bottom) thermal resistance	162	°C/W

(1) For more information about traditional and new thermal metrics, see the *Semiconductor and IC Package Thermal Metrics* application report, [SPRA953](#).

## 6.5 Electrical Characteristics

over operating free-air temperature range (unless otherwise noted)

PARAMETER		TEST CONDITION	MIN	TYP	MAX	UNIT
V <sub>RWM</sub>	Reverse stand-off voltage	Pin 1 to 2 or Pin 2 to 1			5.5	V
I <sub>LEAK</sub>	Leakage current	Pin 1 = 5 V, Pin 2 = 0 V			100	nA
V <sub>Clamp1,2</sub>	Clamp voltage with ESD strike on pin 1, pin 2 grounded.	I <sub>PP</sub> = 1 A, t <sub>p</sub> = 8 to 20 μs <sup>(1)</sup>			10	V
		I <sub>PP</sub> = 5 A, t <sub>p</sub> = 8 to 20 μs <sup>(1)</sup>			14	
V <sub>Clamp2,1</sub>	Clamp voltage with ESD strike on pin 2, pin 1 grounded.	I <sub>PP</sub> = 1 A, t <sub>p</sub> = 8 to 20 μs <sup>(1)</sup>			8.5	V
		I <sub>PP</sub> = 5 A, t <sub>p</sub> = 8 to 20 μs <sup>(1)</sup>			14	
R <sub>DYN</sub>	Dynamic resistance	Pin 1 to Pin 2 <sup>(2)</sup>		0.32		Ω
		Pin 2 to Pin 1 <sup>(2)</sup>		0.38		
C <sub>IO</sub>	I/O capacitance	V <sub>IO</sub> = 2.5 V; f = 1 MHz		12		pF
V <sub>BR1,2</sub>	Break-down voltage, pin 1 to pin 2	I <sub>IO</sub> = 1 mA	6			V
V <sub>BR2,1</sub>	Break-down voltage, pin 2 to pin 1	I <sub>IO</sub> = 1 mA	6			V

(1) Nonrepetitive current pulse 8 to 20 μs exponentially decaying waveform according to IEC 61000-4-5

(2) Extraction of R<sub>DYNAMIC</sub> using least squares fit of TLP characteristics between I<sub>PP</sub> = 10 A and I<sub>PP</sub> = 20 A.

## 6.6 Typical Characteristics

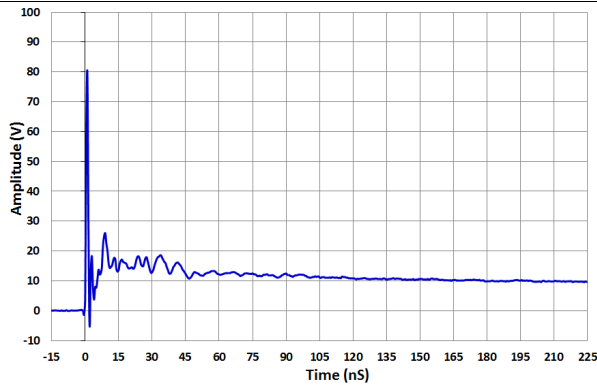

Figure 1. IEC 61000-4-2 Clamp Voltage +8-kV Contact ESD

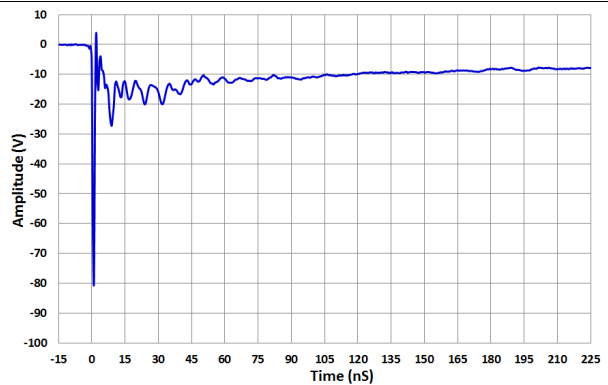

Figure 2. IEC 61000-4-2 Clamp Voltage -8-kV Contact ESD

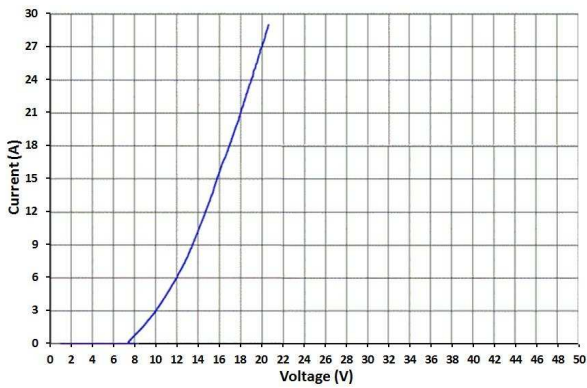

Figure 3. Transmission Line Pulse (TLP) Waveform Pin 1 to Pin 2

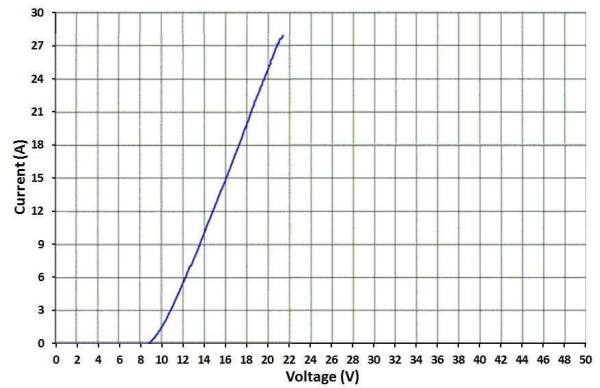

Figure 4. Transmission Line Pulse (TLP) Waveform Pin 2 to Pin 1

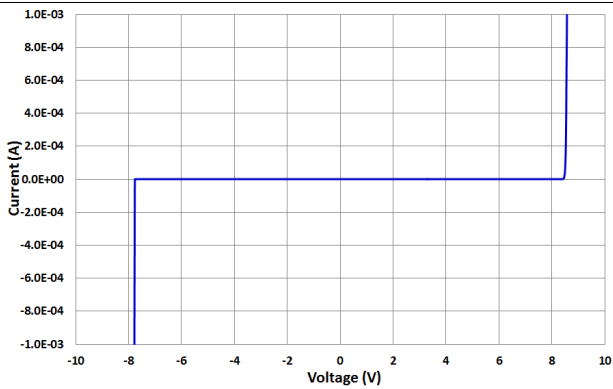

Figure 5. IV Curve

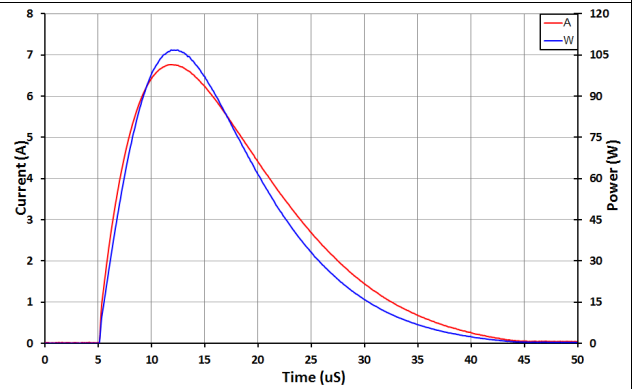
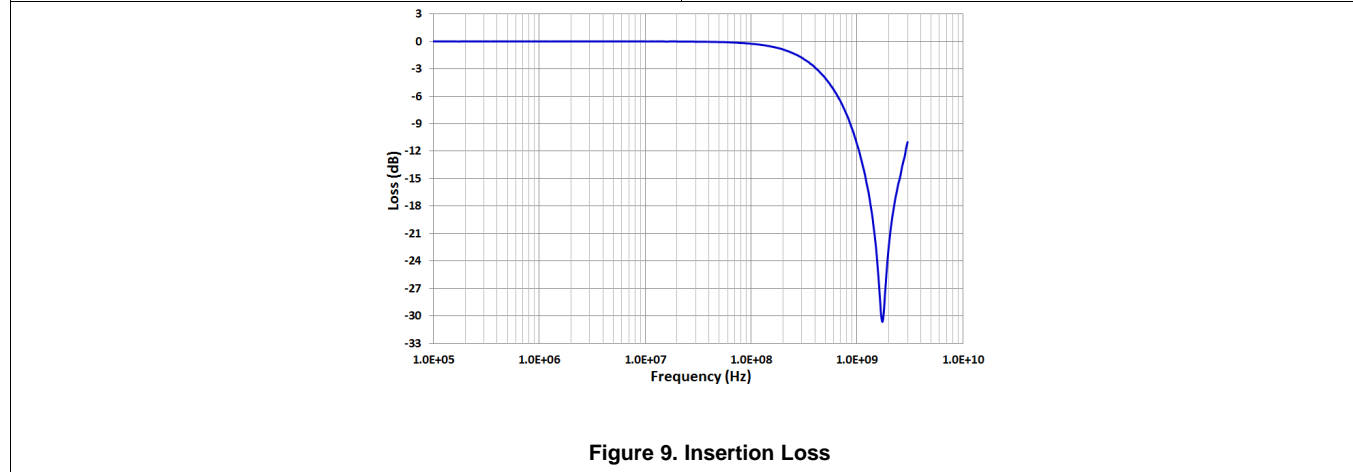
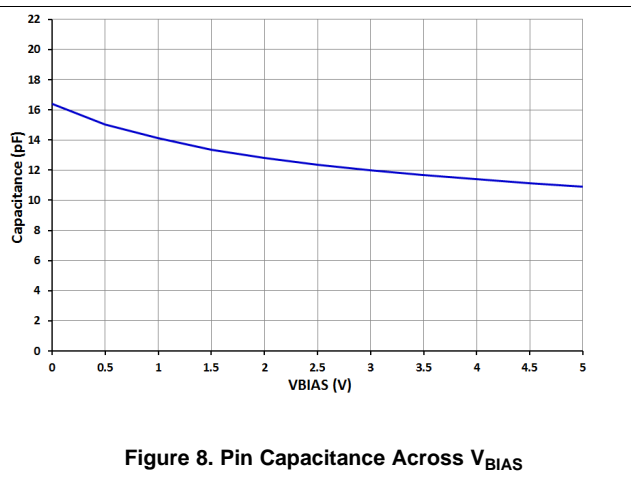
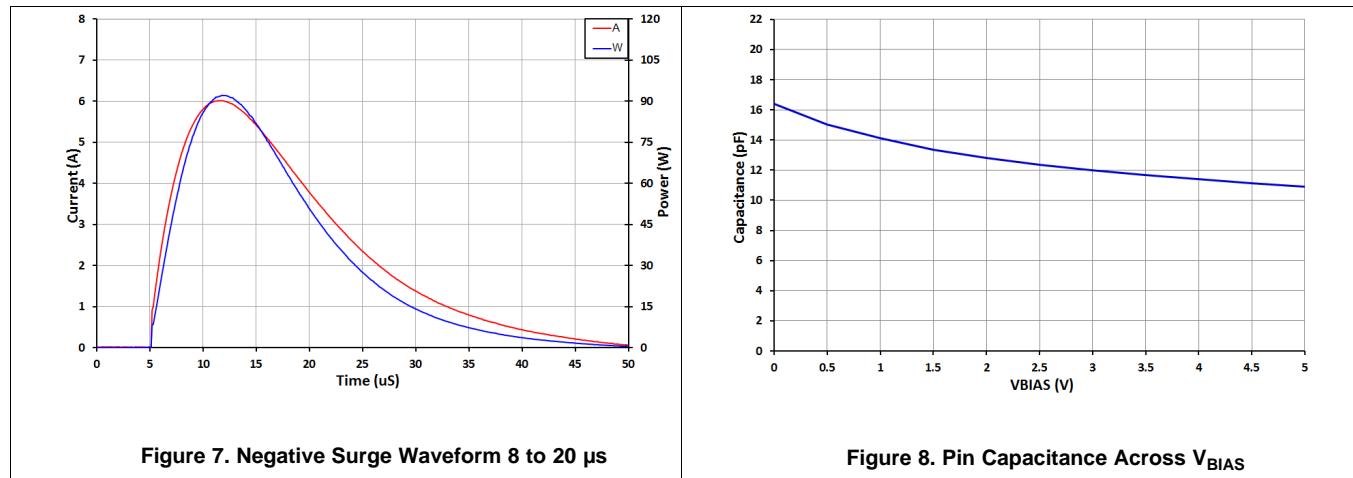

Figure 6. Positive Surge Waveform 8 to 20  $\mu$ s

**Typical Characteristics (continued)**



## 7 Detailed Description

### 7.1 Overview

The TPD1E10B06 is a single-channel ESD TVS diode in a small 0402 package. This TVS protection product offers  $\pm 30$ -kV IEC air-gap,  $\pm 30$ -kV contact ESD protection, and has an ESD clamp circuit with a back-to-back TVS diode for bipolar or bidirectional signal support. The 12-pF line capacitance of this ESD protection diode is suitable for a wide range of applications supporting data rates up to 400 Mbps. The 0402 package is an industry standard and is convenient for component placement in space-saving applications.

Typical application of this ESD protection product is the circuit protection for audio lines (microphone, earphone, and speakerphone), SD interfacing, keypad or other buttons, VBUS pin and ID pin of USB ports, and general-purpose I/O ports. This ESD clamp is a good fit for the protection of the end equipment like ebooks, tablets, remote controllers, wearables, set-top boxes, and electronic point of sale equipment.

### 7.2 Functional Block Diagram

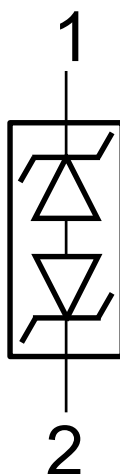

### 7.3 Feature Description

TPD1E10B06 is a bidirectional TVS with high ESD protection level. This device protects circuit from ESD strikes up to  $\pm 30$ -kV contact and  $\pm 30$ -kV air-gap specified in the IEC 61000-4-2 level 4 international standard. The device can also handle up to 6-A surge current (IEC61000-4-5 8/20 $\mu$ s). The I/O capacitance of 12 pF supports a data rate up to 400 Mbps. This clamping device has a small dynamic resistance of 0.4  $\Omega$  typically, which makes the clamping voltage low when the device is actively protecting other circuits. For example, the clamping voltage is only 10 V when the device is taking 1-A transient current. The breakdown is bidirectional so that this protection device is a good fit for GPIO and especially audio lines which carry bidirectional signals. Low leakage allows the diode to conserve power when working below the  $V_{RWM}$ . The industrial temperature range of  $-40^{\circ}\text{C}$  to  $125^{\circ}\text{C}$  makes this ESD device work at extensive temperatures in most environments. The space-saving 0402 package can fit into small electronic devices like mobile equipment and wearables.

### 7.4 Device Functional Modes

TPD1E10B06 is a passive clamp that has low leakage during normal operation when the voltage between pin 1 and pin 2 is below  $V_{RWM}$  and activates when the voltage between pin 1 and pin 2 goes above  $V_{BR}$ . During IEC ESD events, transient voltages as high as  $\pm 30$  kV can be clamped between the two pins. When the voltages on the protected lines fall below the trigger voltage, the device reverts back to the low leakage passive state.

## 8 Application and Implementation

### NOTE

Information in the following applications sections is not part of the TI component specification, and TI does not warrant its accuracy or completeness. TI's customers are responsible for determining suitability of components for their purposes. Customers should validate and test their design implementation to confirm system functionality.

### 8.1 Application Information

When a system contains a human interface connector, the system becomes vulnerable to large system-level ESD strikes that standard ICs cannot survive. TVS ESD protection diodes are typically used to suppress ESD at these connectors. TPD1E10B06 is a single-channel ESD protection device containing back-to-back TVS diodes, which is typically used to provide a path to ground for dissipating ESD events on bidirectional signal lines between a human interface connector and a system. As the current from ESD passes through the device, only a small voltage drop is present across the diode structure. This is the voltage presented to the protected IC. The low  $R_{DYN}$  of the triggered TVS holds this voltage,  $V_{CLAMP}$ , to a tolerable level to the protected IC.

### 8.2 Typical Application

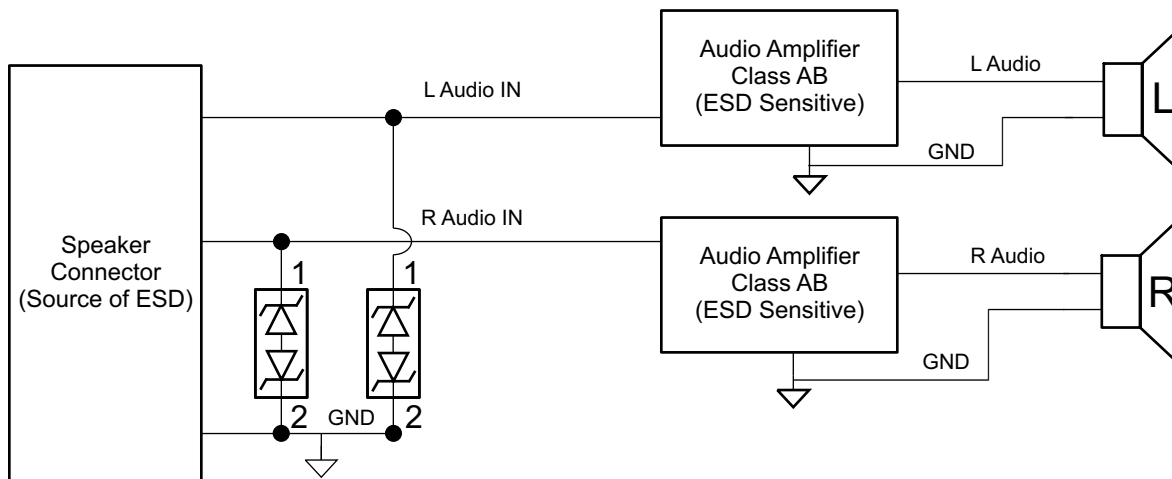

Figure 10. Typical Application Schematic

#### 8.2.1 Design Requirements

For this design example, two TPD1E10B06s will be used to protect left and right audio channels. For this audio application, the following system parameters are known.

Table 1. Design Parameters

DESIGN PARAMETER	VALUE
Audio Amplifier Class	AB
Audio signal voltage range	-3 V to 3 V
Audio frequency content	20 Hz to 20 kHz
Required IEC 61000-4-2 ESD Protection	±20-kV Contact/ ±25-kV Air-Gap

#### 8.2.2 Detailed Design Procedure

To begin the design process, some parameters must be decided upon; the designer should make sure:

- Voltage range on the protected line must not exceed the reverse standoff voltage of the TVS diode(s) ( $V_{RWM}$ )
- Operating frequency is supported by the I/O capacitance  $C_{IO}$  of the TVS diode
- IEC 61000-4-2 protection requirement is covered by the IEC performance of the TVS diode



For this application, the audio signal voltage range is  $-3\text{ V}$  to  $3\text{ V}$ . The  $V_{RWM}$  for the TVS is  $-5.5\text{ V}$  to  $5.5\text{ V}$ ; therefore, the bidirectional TVS will not break down during normal operation, and therefore normal operation of the audio signal will not be effected due to the signal voltage range. In this application, a bidirectional TVS like TPD1E10B06 is required.

Next, consider the frequency content of this audio signal. In this application with the class AB amplifier, the frequency content is from  $20\text{ Hz}$  to  $20\text{ kHz}$ ; ensure that the TVS I/O capacitance will not distort this signal by filtering it. With TPD1E10B06 typical capacitance of  $12\text{ pF}$ , which leads to a typical 3-dB bandwidth of  $400\text{ MHz}$ , this diode has sufficient bandwidth to pass the audio signal without distorting it.

Finally, the human interface in this application requires above standard Level 4 IEC 61000-4-2 system-level ESD protection ( $\pm 20\text{-kV}$  Contact/  $\pm 25\text{-kV}$  Air-Gap). A standard TVS cannot survive this level of IEC ESD stress. However, TPD1E10B06 can survive at least  $\pm 30\text{-kV}$  Contact/  $\pm 30\text{-kV}$  Air-Gap. Therefore, the device can provide sufficient ESD protection for the interface, even though the requirements are stringent. For any TVS diode to provide the full range of ESD protection capabilities, as well as to minimize the noise and EMI disturbances the board will see during ESD events, a system designer must use proper board layout of their TVS ESD protection diodes. See [Layout](#) for instructions on properly laying out TPD1E10B06.

### 8.2.3 Application Curves

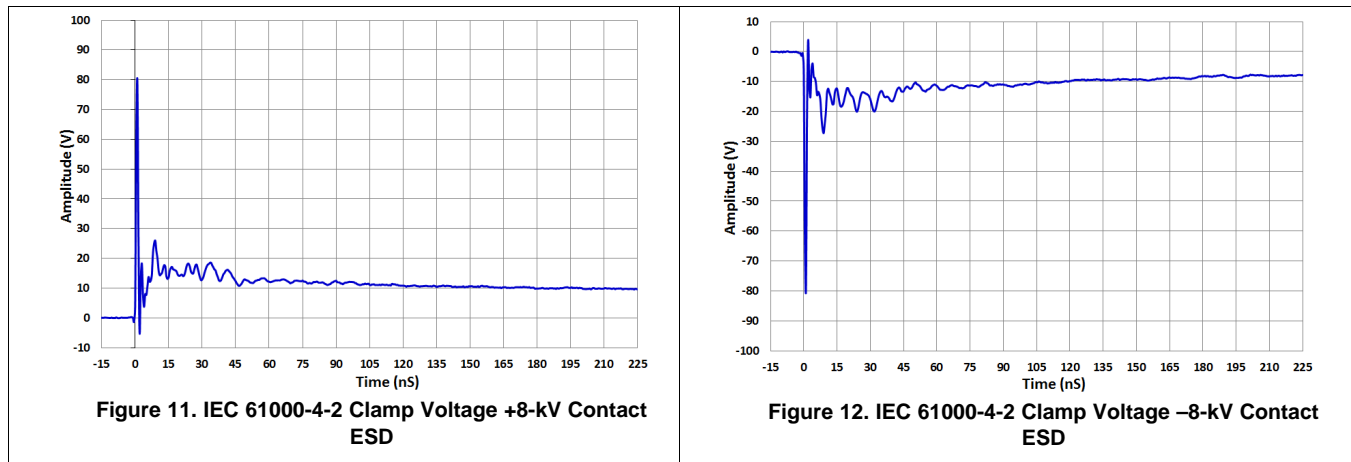

## 9 Power Supply Recommendations

This device is a passive TVS diode-based ESD protection device, therefore there is no requirement to power it. Take care to make sure that the maximum voltage specifications for each pin are not violated.

## 10 Layout

### 10.1 Layout Guidelines

- The optimum placement is as close to the connector as possible.
  - EMI during an ESD event can couple from the trace being struck to other nearby unprotected traces, resulting in early system failures.
  - The PCB designer must minimize the possibility of EMI coupling by keeping any unprotected traces away from the protected traces which are between the TVS and the connector.
- Route the protected traces as straight as possible.
- Eliminate any sharp corners on the protected traces between the TVS and the connector by using rounded corners with the largest radii possible.
  - Electric fields tend to build up on corners, increasing EMI coupling.
- If pin 1 or pin 2 is connected to ground, use a thick and short trace for this return path

### 10.2 Layout Example

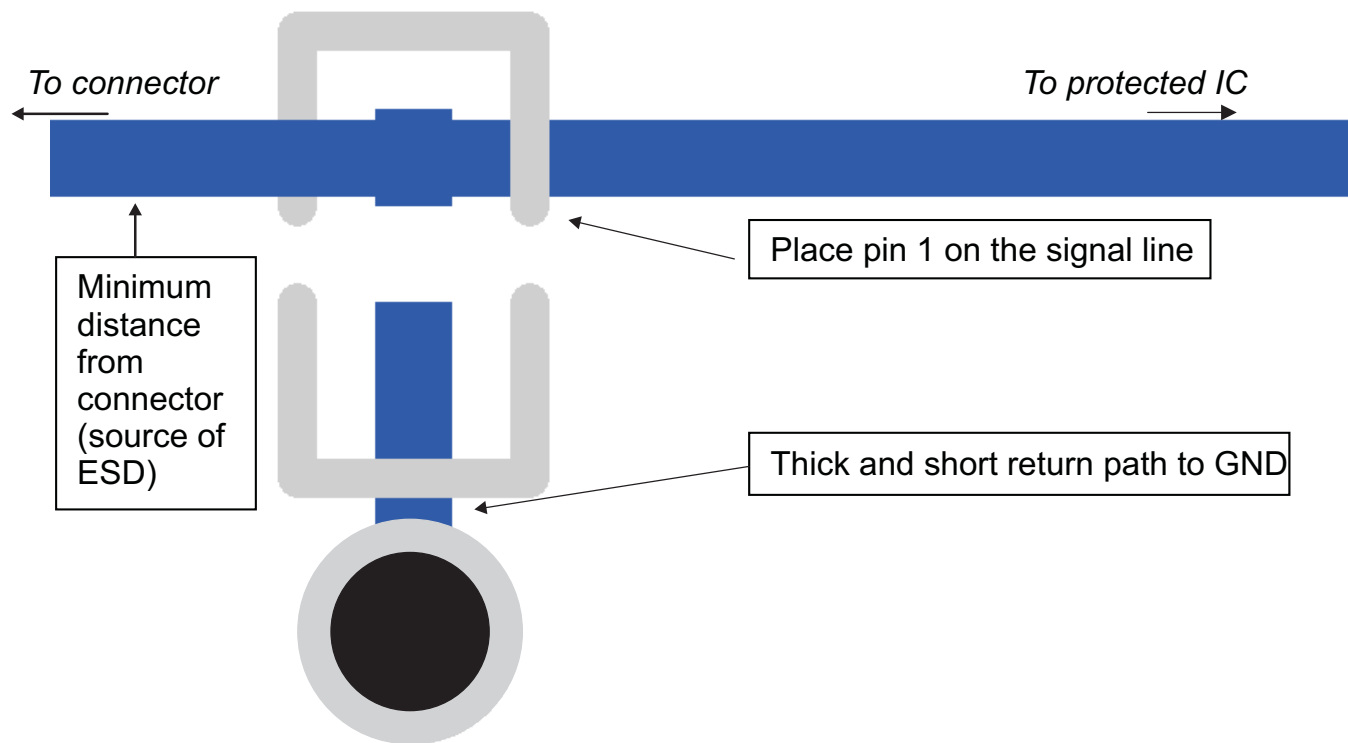

**Figure 13. Layout Recommendation**

## 11 Device and Documentation Support

### 11.1 Community Resources

The following links connect to TI community resources. Linked contents are provided "AS IS" by the respective contributors. They do not constitute TI specifications and do not necessarily reflect TI's views; see TI's [Terms of Use](#).

**TI E2E™ Online Community** *TI's Engineer-to-Engineer (E2E) Community*. Created to foster collaboration among engineers. At [e2e.ti.com](http://e2e.ti.com), you can ask questions, share knowledge, explore ideas and help solve problems with fellow engineers.

**Design Support** *TI's Design Support* Quickly find helpful E2E forums along with design support tools and contact information for technical support.

### 11.2 Trademarks

E2E is a trademark of Texas Instruments.  
All other trademarks are the property of their respective owners.

### 11.3 Electrostatic Discharge Caution



These devices have limited built-in ESD protection. The leads should be shorted together or the device placed in conductive foam during storage or handling to prevent electrostatic damage to the MOS gates.

### 11.4 Glossary

[SLYZ022](#) — *TI Glossary*.

This glossary lists and explains terms, acronyms, and definitions.

## 12 Mechanical, Packaging, and Orderable Information

The following pages include mechanical, packaging, and orderable information. This information is the most current data available for the designated devices. This data is subject to change without notice and revision of this document. For browser-based versions of this data sheet, refer to the left-hand navigation.

**PACKAGING INFORMATION**

Orderable Device	Status (1)	Package Type	Package Drawing	Pins	Package Qty	Eco Plan (2)	Lead/Ball Finish (6)	MSL Peak Temp (3)	Op Temp (°C)	Device Marking (4/5)	Samples
TPD1E10B06DPYR	ACTIVE	X1SON	DPY	2	10000	Green (RoHS & no Sb/Br)	CU NIPDAU	Level-1-260C-UNLIM	-40 to 125	(B1, B2, B6, BI)	<a href="#">Samples</a>
TPD1E10B06DPYT	ACTIVE	X1SON	DPY	2	250	Green (RoHS & no Sb/Br)	CU NIPDAU	Level-1-260C-UNLIM	-40 to 125	(B1, B2, B6, BI)	<a href="#">Samples</a>

(1) The marketing status values are defined as follows:

**ACTIVE:** Product device recommended for new designs.

**LIFEBUY:** TI has announced that the device will be discontinued, and a lifetime-buy period is in effect.

**NRND:** Not recommended for new designs. Device is in production to support existing customers, but TI does not recommend using this part in a new design.

**PREVIEW:** Device has been announced but is not in production. Samples may or may not be available.

**OBSELETE:** TI has discontinued the production of the device.

(2) **RoHS:** TI defines "RoHS" to mean semiconductor products that are compliant with the current EU RoHS requirements for all 10 RoHS substances, including the requirement that RoHS substance do not exceed 0.1% by weight in homogeneous materials. Where designed to be soldered at high temperatures, "RoHS" products are suitable for use in specified lead-free processes. TI may reference these types of products as "Pb-Free".

**RoHS Exempt:** TI defines "RoHS Exempt" to mean products that contain lead but are compliant with EU RoHS pursuant to a specific EU RoHS exemption.

**Green:** TI defines "Green" to mean the content of Chlorine (Cl) and Bromine (Br) based flame retardants meet JS709B low halogen requirements of <=1000ppm threshold. Antimony trioxide based flame retardants must also meet the <=1000ppm threshold requirement.

(3) MSL, Peak Temp. - The Moisture Sensitivity Level rating according to the JEDEC industry standard classifications, and peak solder temperature.

(4) There may be additional marking, which relates to the logo, the lot trace code information, or the environmental category on the device.

(5) Multiple Device Markings will be inside parentheses. Only one Device Marking contained in parentheses and separated by a "-" will appear on a device. If a line is indented then it is a continuation of the previous line and the two combined represent the entire Device Marking for that device.

(6) Lead/Ball Finish - Orderable Devices may have multiple material finish options. Finish options are separated by a vertical ruled line. Lead/Ball Finish values may wrap to two lines if the finish value exceeds the maximum column width.

**Important Information and Disclaimer:**The information provided on this page represents TI's knowledge and belief as of the date that it is provided. TI bases its knowledge and belief on information provided by third parties, and makes no representation or warranty as to the accuracy of such information. Efforts are underway to better integrate information from third parties. TI has taken and continues to take reasonable steps to provide representative and accurate information but may not have conducted destructive testing or chemical analysis on incoming materials and chemicals. TI and TI suppliers consider certain information to be proprietary, and thus CAS numbers and other limited information may not be available for release.

In no event shall TI's liability arising out of such information exceed the total purchase price of the TI part(s) at issue in this document sold by TI to Customer on an annual basis.

**OTHER QUALIFIED VERSIONS OF TPD1E10B06 :**

- Automotive: [TPD1E10B06-Q1](#)

## NOTE: Qualified Version Definitions:

- Automotive - Q100 devices qualified for high-reliability automotive applications targeting zero defects

**TAPE AND REEL INFORMATION**

**QUADRANT ASSIGNMENTS FOR PIN 1 ORIENTATION IN TAPE**

\*All dimensions are nominal

Device	Package Type	Package Drawing	Pins	SPQ	Reel Diameter (mm)	Reel Width W1 (mm)	A0 (mm)	B0 (mm)	K0 (mm)	P1 (mm)	W (mm)	Pin1 Quadrant
TPD1E10B06DPYR	X1SON	DPY	2	10000	180.0	9.5	0.72	1.12	0.43	2.0	8.0	Q1
TPD1E10B06DPYR	X1SON	DPY	2	10000	180.0	9.5	0.66	1.15	0.66	2.0	8.0	Q1
TPD1E10B06DPYR	X1SON	DPY	2	10000	180.0	8.4	0.7	1.1	0.47	4.0	8.0	Q1
TPD1E10B06DPYR	X1SON	DPY	2	10000	178.0	8.4	0.7	1.15	0.47	2.0	8.0	Q1
TPD1E10B06DPYT	X1SON	DPY	2	250	180.0	9.5	0.72	1.12	0.43	2.0	8.0	Q1
TPD1E10B06DPYT	X1SON	DPY	2	250	180.0	9.5	0.66	1.15	0.66	2.0	8.0	Q1
TPD1E10B06DPYT	X1SON	DPY	2	250	178.0	8.4	0.7	1.15	0.47	2.0	8.0	Q1

**TAPE AND REEL BOX DIMENSIONS**

\*All dimensions are nominal

Device	Package Type	Package Drawing	Pins	SPQ	Length (mm)	Width (mm)	Height (mm)
TPD1E10B06DPYR	X1SON	DPY	2	10000	189.0	185.0	36.0
TPD1E10B06DPYR	X1SON	DPY	2	10000	184.0	184.0	19.0
TPD1E10B06DPYR	X1SON	DPY	2	10000	203.2	196.8	33.3
TPD1E10B06DPYR	X1SON	DPY	2	10000	205.0	200.0	33.0
TPD1E10B06DPYT	X1SON	DPY	2	250	189.0	185.0	36.0
TPD1E10B06DPYT	X1SON	DPY	2	250	184.0	184.0	19.0
TPD1E10B06DPYT	X1SON	DPY	2	250	205.0	200.0	33.0

DPY (R-PX1SON-N2)

PLASTIC SMALL OUTLINE NO-LEAD

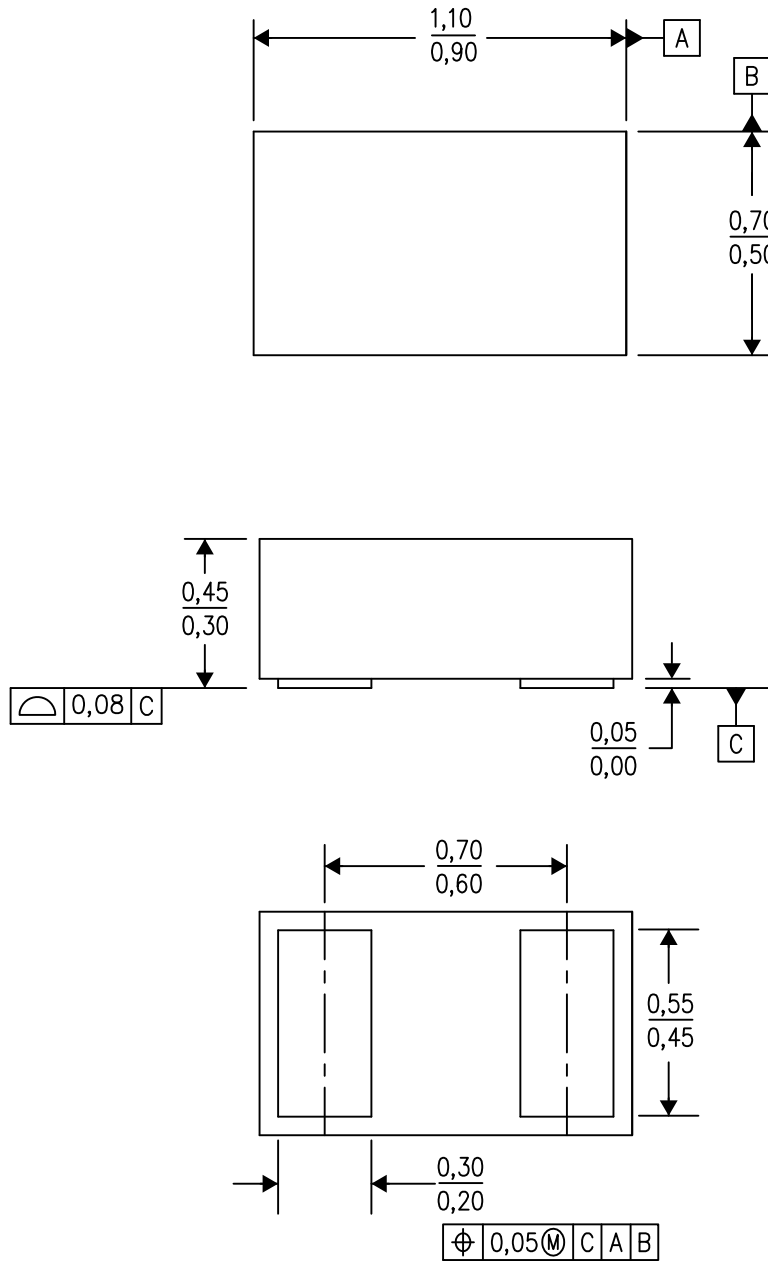

4211012/D 08/14

- NOTES:
- All linear dimensions are in millimeters. Dimensioning and tolerancing per ASME Y14.5-1994.
  - This drawing is subject to change without notice.
  - SON (Small Outline No-Lead) package configuration.



DPY (R-PX1SON-N2)

PLASTIC SMALL OUTLINE NO-LEAD

Example Board Layout

Example Stencil Design  
(Note E)

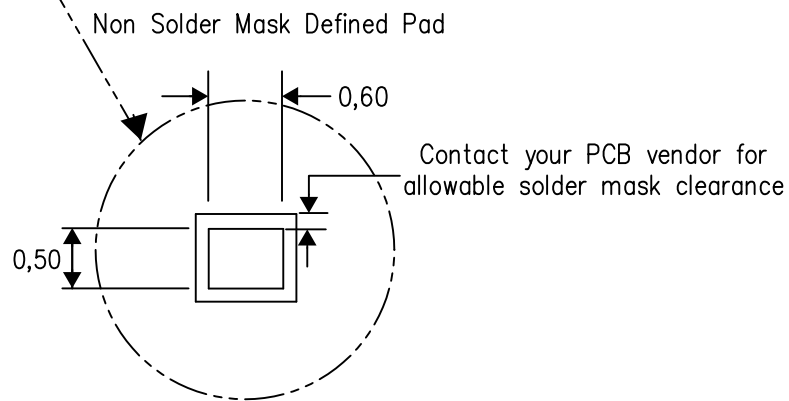
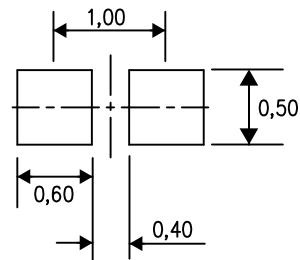
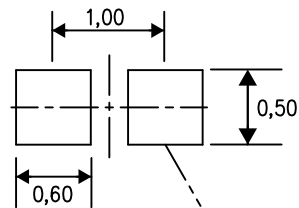

4215270/B 08/15

- NOTES:
- A. All linear dimensions are in millimeters.
  - B. This drawing is subject to change without notice.
  - C. Publication IPC-7351 is recommended for alternate designs.
  - D. Customers should contact their board fabrication site for minimum solder mask web tolerances between signal pads.
  - E. Maximum stencil thickness 0,127 mm (5 mils). All linear dimensions are in millimeters.
  - F. Laser cutting apertures with trapezoidal walls and also rounding corners will offer better paste release. Customers should contact their board assembly site for stencil design recommendations. Refer to IPC 7525 for stencil design considerations.
  - G. Side aperture dimensions over-print land for acceptable area ratio > 0.66. Customer may reduce side aperture dimensions if stencil manufacturing process allows for sufficient release at smaller opening.

## IMPORTANT NOTICE

Texas Instruments Incorporated (TI) reserves the right to make corrections, enhancements, improvements and other changes to its semiconductor products and services per JESD46, latest issue, and to discontinue any product or service per JESD48, latest issue. Buyers should obtain the latest relevant information before placing orders and should verify that such information is current and complete.

TI's published terms of sale for semiconductor products (<http://www.ti.com/sc/docs/stdterms.htm>) apply to the sale of packaged integrated circuit products that TI has qualified and released to market. Additional terms may apply to the use or sale of other types of TI products and services.

Reproduction of significant portions of TI information in TI data sheets is permissible only if reproduction is without alteration and is accompanied by all associated warranties, conditions, limitations, and notices. TI is not responsible or liable for such reproduced documentation. Information of third parties may be subject to additional restrictions. Resale of TI products or services with statements different from or beyond the parameters stated by TI for that product or service voids all express and any implied warranties for the associated TI product or service and is an unfair and deceptive business practice. TI is not responsible or liable for any such statements.

Buyers and others who are developing systems that incorporate TI products (collectively, "Designers") understand and agree that Designers remain responsible for using their independent analysis, evaluation and judgment in designing their applications and that Designers have full and exclusive responsibility to assure the safety of Designers' applications and compliance of their applications (and of all TI products used in or for Designers' applications) with all applicable regulations, laws and other applicable requirements. Designer represents that, with respect to their applications, Designer has all the necessary expertise to create and implement safeguards that (1) anticipate dangerous consequences of failures, (2) monitor failures and their consequences, and (3) lessen the likelihood of failures that might cause harm and take appropriate actions. Designer agrees that prior to using or distributing any applications that include TI products, Designer will thoroughly test such applications and the functionality of such TI products as used in such applications.

TI's provision of technical, application or other design advice, quality characterization, reliability data or other services or information, including, but not limited to, reference designs and materials relating to evaluation modules, (collectively, "TI Resources") are intended to assist designers who are developing applications that incorporate TI products; by downloading, accessing or using TI Resources in any way, Designer (individually or, if Designer is acting on behalf of a company, Designer's company) agrees to use any particular TI Resource solely for this purpose and subject to the terms of this Notice.

TI's provision of TI Resources does not expand or otherwise alter TI's applicable published warranties or warranty disclaimers for TI products, and no additional obligations or liabilities arise from TI providing such TI Resources. TI reserves the right to make corrections, enhancements, improvements and other changes to its TI Resources. TI has not conducted any testing other than that specifically described in the published documentation for a particular TI Resource.

Designer is authorized to use, copy and modify any individual TI Resource only in connection with the development of applications that include the TI product(s) identified in such TI Resource. NO OTHER LICENSE, EXPRESS OR IMPLIED, BY ESTOPPEL OR OTHERWISE TO ANY OTHER TI INTELLECTUAL PROPERTY RIGHT, AND NO LICENSE TO ANY TECHNOLOGY OR INTELLECTUAL PROPERTY RIGHT OF TI OR ANY THIRD PARTY IS GRANTED HEREIN, including but not limited to any patent right, copyright, mask work right, or other intellectual property right relating to any combination, machine, or process in which TI products or services are used. Information regarding or referencing third-party products or services does not constitute a license to use such products or services, or a warranty or endorsement thereof. Use of TI Resources may require a license from a third party under the patents or other intellectual property of the third party, or a license from TI under the patents or other intellectual property of TI.

TI RESOURCES ARE PROVIDED "AS IS" AND WITH ALL FAULTS. TI DISCLAIMS ALL OTHER WARRANTIES OR REPRESENTATIONS, EXPRESS OR IMPLIED, REGARDING RESOURCES OR USE THEREOF, INCLUDING BUT NOT LIMITED TO ACCURACY OR COMPLETENESS, TITLE, ANY EPIDEMIC FAILURE WARRANTY AND ANY IMPLIED WARRANTIES OF MERCHANTABILITY, FITNESS FOR A PARTICULAR PURPOSE, AND NON-INFRINGEMENT OF ANY THIRD PARTY INTELLECTUAL PROPERTY RIGHTS. TI SHALL NOT BE LIABLE FOR AND SHALL NOT DEFEND OR INDEMNIFY DESIGNER AGAINST ANY CLAIM, INCLUDING BUT NOT LIMITED TO ANY INFRINGEMENT CLAIM THAT RELATES TO OR IS BASED ON ANY COMBINATION OF PRODUCTS EVEN IF DESCRIBED IN TI RESOURCES OR OTHERWISE. IN NO EVENT SHALL TI BE LIABLE FOR ANY ACTUAL, DIRECT, SPECIAL, COLLATERAL, INDIRECT, PUNITIVE, INCIDENTAL, CONSEQUENTIAL OR EXEMPLARY DAMAGES IN CONNECTION WITH OR ARISING OUT OF TI RESOURCES OR USE THEREOF, AND REGARDLESS OF WHETHER TI HAS BEEN ADVISED OF THE POSSIBILITY OF SUCH DAMAGES.

Unless TI has explicitly designated an individual product as meeting the requirements of a particular industry standard (e.g., ISO/TS 16949 and ISO 26262), TI is not responsible for any failure to meet such industry standard requirements.

Where TI specifically promotes products as facilitating functional safety or as compliant with industry functional safety standards, such products are intended to help enable customers to design and create their own applications that meet applicable functional safety standards and requirements. Using products in an application does not by itself establish any safety features in the application. Designers must ensure compliance with safety-related requirements and standards applicable to their applications. Designer may not use any TI products in life-critical medical equipment unless authorized officers of the parties have executed a special contract specifically governing such use. Life-critical medical equipment is medical equipment where failure of such equipment would cause serious bodily injury or death (e.g., life support, pacemakers, defibrillators, heart pumps, neurostimulators, and implantables). Such equipment includes, without limitation, all medical devices identified by the U.S. Food and Drug Administration as Class III devices and equivalent classifications outside the U.S.

TI may expressly designate certain products as completing a particular qualification (e.g., Q100, Military Grade, or Enhanced Product). Designers agree that it has the necessary expertise to select the product with the appropriate qualification designation for their applications and that proper product selection is at Designers' own risk. Designers are solely responsible for compliance with all legal and regulatory requirements in connection with such selection.

Designer will fully indemnify TI and its representatives against any damages, costs, losses, and/or liabilities arising out of Designer's non-compliance with the terms and provisions of this Notice.