

Category: 预铸式连接器/Plug-in terminal-plug

Product name: 预铸式M12A08Z-MMSRA-UP001B

Product Description: M12 A-code , 8芯预铸成型式非屏蔽公弯头连接器 带有1米长黑色PUR线缆



Product Picture

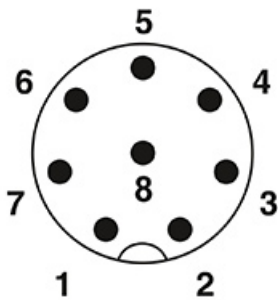
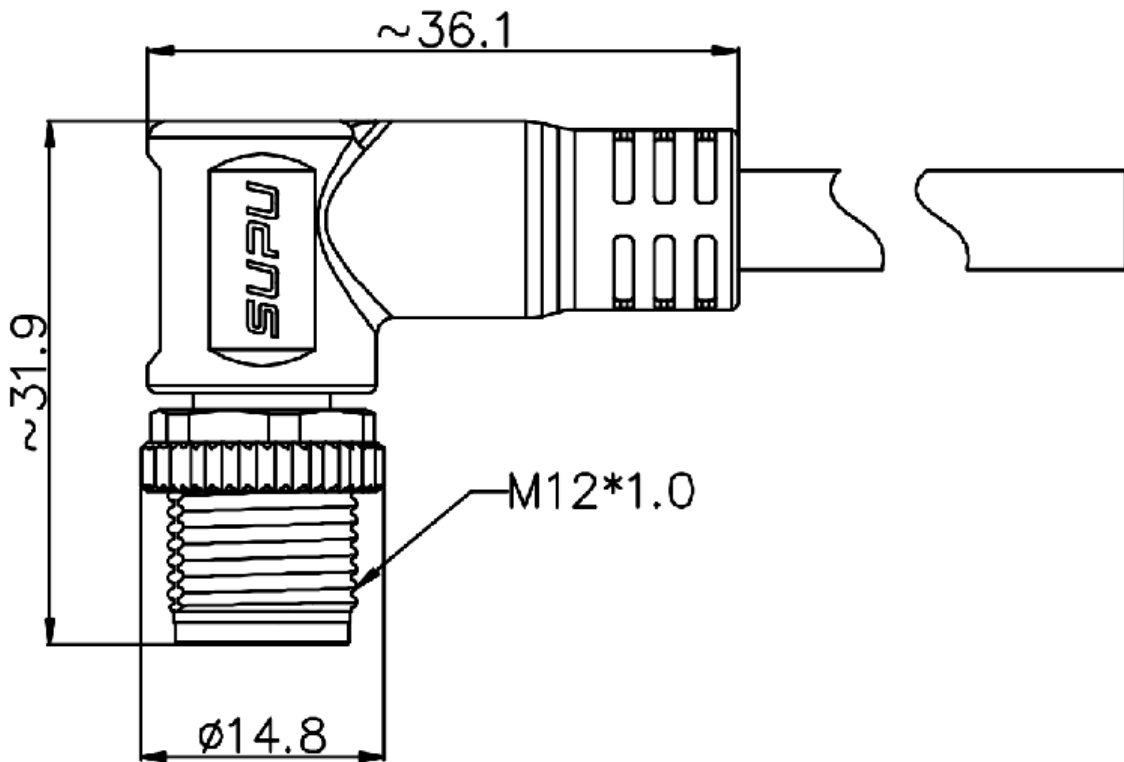

基本信息 /Basic Information

产品型号 SUPU ID	M12A08Z-MMSRA-UP001B
接口螺纹规格 Thread type	M12

产品位数 Number of positions	8
接口编码类型 Coding	A-Coding
防护等级 Degree of protection	IP67
连接方式 Connection method	预铸成型式
产品类型 Type	针式 弯头
是否屏蔽 Shielding	否
机械寿命 Mounting cycle	≥100
参照标准 Standards	IEC61076-2-101

电气参数 /Electrical properties

额定电压 Rated Voltage	30V DC
额定电流 Rated Current	2A
绝缘阻抗 Insulation Resistance	≥100MΩ
接触阻抗 Contact resistance	< 10mΩ
污染等级 Degree of pollution	3
工作温度 Ambient temperature (operation)	-40~+85°C

材料信息 /Material Data

插针/表面材料 Contact material/plating	CuZn/Ni/Au
插芯材料 Contact carrier material	TPU
螺丝/螺母材料 Screw/nut material	Zinc
密封材料 Sealing material	NBR

线缆参数 /Cable Data

导线长度 Cable length	1m
外套保护材料 Outer sheath material	PUR
外套保护颜色 External sheath color	黑色

Ningbo Supu Electronics Co.,Ltd

Address: No. 625, Kandun Town Street, Cixi
City, Zhejiang Province

Zip code: 315303

Switchboard: +86 574-63288158

Fax: +86 574-63288170

E-mail : askme@supu.cn

E-mail : askme@supu.cn

Service Hotline: 400-626-6336



Code

File date : 2024-09-12 17:05

Product Entry : 2023-09-07

The right to modify data belongs to
Supu.